

SIEMENS



Room thermostat with display, for VAV RDG400

Basic Documentation

Edition: 1.2

CE1P3182en
13 Aug 2009

Building Technologies

Contents

1	About this document	4
1.1	Revision history	4
1.2	Reference documents	4
1.3	Before you start	4
1.3.1	Copyright	4
1.3.2	Quality assurance	4
1.3.3	Document use / request to the reader	5
2	Summary	6
2.1	Brief description	6
2.2	Types and features	7
2.3	Equipment combinations	7
2.4	Accessories	8
2.5	Ordering	8
3	Use	8
4	Functions	9
4.1	Temperature control	9
4.2	Operating modes	10
4.3	Room temperature Setpoints	11
4.4	Setpoints and sequences	12
4.5	Applications overview	14
4.6	Additional features	15
4.7	Control sequences	18
4.7.1	Applications and sequences	18
4.7.2	Sequences overview (setting via parameter P01)	18
4.7.3	Control outputs configuration (setting via DIP 4 / 5 and parameters P46 / P47)	19
4.7.4	Single-duct	20
4.7.5	Single-duct with electrical heater	21
4.7.6	Single-duct with radiator or floor heating	22
4.7.7	Single-duct with heating / cooling coil	23
4.8	Control outputs	24
4.8.1	Control output for air flow	24
4.8.2	Control output for electrical heater, radiator and heating / cooling coil	25
4.9	Multifunctional input, digital input	27
4.10	Handling of faults	28
4.11	DIP switches	28
4.12	Control parameters	29
4.12.1	Parameters of the "Service level"	30
4.12.2	Parameters of the "Expert level" with "Diagnostics and test"	31
5	Handling	33
5.1	Mounting and installation	33
5.2	Operation	34
5.3	Disposal	35

6	Engineering	36
6.1	Connection terminals	36
6.2	Connection diagrams	37
7	Mechanical design	38
7.1	General	38
7.2	Dimensions	38
8	Technical data	39
Index	41

1 About this document

1.1 Revision history

Edition	Date	Changes	Section	Pages
1.2	August 2009	Parameter d01 (diagnostics)	4.12.2	31 f
1.1	June 2009	Layout and language corrections	all	
1.0	May 2009	First edition		

1.2 Reference documents

Ref.	Document title	Type of document	Document no.
[1]	Wall-mounted room thermostat with LCD	Data Sheet	CE1N3182en
[2]	RDG400	Operating Instructions	CE1B3182en
[3]	RDG400	Mounting Instructions	CE1M3182en

1.3 Before you start

1.3.1 Copyright

This document may be duplicated and distributed only with the express permission of Siemens, and may be passed only to authorized persons or companies with the required technical knowledge.

1.3.2 Quality assurance

This document was prepared with great care.

- The contents of this document is checked at regular intervals.
- Any corrections necessary are included in subsequent versions.
- Documents are automatically amended as a consequence of modifications and corrections to the products described.

Please make sure that you are aware of the latest document revision date.

If you find lack of clarity while using this document, or if you have any criticisms or suggestions, please contact the Product Manager in your nearest branch office.

The addresses of the Siemens Regional Companies are available at

www.buildingtechnologies.siemens.com.

1.3.3 Document use / request to the reader

Before using our products, it is important that you read the documents supplied with or ordered at the same time as the products (equipment, applications, tools etc.) carefully and in full.

We assume that persons using our products and documents are authorized and trained appropriately and have the technical knowledge required to use our products as intended.

More information on the products and applications is available:

- On the intranet (Siemens employees only) at <https://workspace.sbt.siemens.com/content/00001123/default.aspx>
- From the Siemens branch office near you www.buildingtechnologies.siemens.com or from your system supplier
- From the support team at headquarters fieldsupport-zug.ch.sbt@siemens.com if there is no local point of contact

Siemens assumes no liability to the extent allowed under the law for any losses resulting from a failure to comply with the aforementioned points or for the improper compliance of the same.

2 Summary

2.1 Brief description

Applications

- Single-duct system
- Single-duct system with electrical heater
- Single-duct system and radiator / floor heating
- Single-duct system with heating / cooling coil

Features

- 2 multifunctional inputs and 1 digital input for keycard contact, external sensor, etc.
- Operating modes: Comfort, Energy Saving and Protection
- Automatic or manual heating / cooling changeover
- Adjustable commissioning and control parameters
- Minimum and maximum setpoint limitation
- Backlit LCD

- AC 24 V operating voltage
- Modulating PI/P control
- Output DC 0...10 V
- Output signal inversion (DC 10...0 V) as an option
- Output on/off, PWM or 3-position control
- Adjustable minimum and maximum limitation of air flow output signal

Functions















- Maintenance of room temperature via built-in temperature sensor or external room temperature / return air temperature sensor
- Automatic or manual changeover between heating and cooling mode
- Selection of applications via DIP switches
- Selection of operating mode via the operating mode button on the thermostat
- Display of current room temperature or setpoint in °C and/or °F
- Minimum and maximum setpoint limitation
- Button lock (automatic or manual)
- 1 digital input, freely selectable for:
 - Operating mode switchover contact (keycard)
 - Automatic heating / cooling changeover contact
 - Dewpoint sensor
 - Electrical heater enable
 - Fault input
- 2 multifunctional inputs, freely selectable for:
 - Operating mode switchover contact (keycard)
 - Automatic heating / cooling changeover sensor
 - External room temperature or return air temperature
 - Dewpoint sensor
 - Electrical heater enable
 - Fault input
- Floor heating temperature limit
- Reloading factory settings for commissioning and control parameters









2.2 Types and features

Product no.	Operating voltage	Number of control outputs				Backlit LCD
		ON/OFF	PWM	3-pos	DC 0...10 V	
RDG400	AC 24 V	1 ¹⁾	1 ¹⁾	1 ¹⁾	1	✓

1) Either ON/OFF, 3-position or PWM (triac outputs)

2.3 Equipment combinations

Description		Product no.	Data Sheet
Cable temperature sensor		QAH11.1	1840
Room temperature sensor		QAA32	1747
Condensation detector / extension module		QXA2000 / AQX2000	1542
Electrical actuator, DC 0..10 V (for radiator valves)		SSA61...	4893
Electrical actuator, DC 0..10 V (for 2- and 3-port valves / V...P45)		SSC61...	4895
Electrical actuator, DC 0..10 V (for small valves 2.5 mm)		SSP61...	4864
Electrical actuator, DC 0..10 V (for small valves 5.5 mm)		SSB61...	4891
Electrical actuator, DC 0..10 V (for CombiValves VPI45)		SSD61...	4861
Thermal actuator, DC 0..10 V (for small valves and radiator valves)		STS61	4880
DC 0...10 V damper actuator		GQD161...	4605
		GDB161...	4634
		GLB161...	
		GMA161...	4614
		GEB161...	4621
		GCA161...	4613
		GBB161...	4626
		GIB161...	
VAV compact controller		GDB181.1E/3	3544
		GLB181.1E/3	

ON/OFF actuators AC 24 V	Electromotoric ON/OFF valve and actuator (only available in AP, UAE, SA and IN)		MVI.../MXI...	4867
	Electromotoric ON/OFF actuator		SFA71...	4863
	Thermal actuator (for radiator valves)		STA71...	4877
	Thermal actuator (for small valves 2.5 mm)		STP71...	4878
3-position actuators AC 24 V	Electrical actuator, 3-position (for radiator valve)		SSA81...	4893
	Electrical actuator, 3-position (for small valve 2,5 mm)		SSP81...	4864
	Electrical actuator, 3-position (for small valve 5,5 mm)		SSB81...	4891
	Electrical actuator, 3-position (for Combi-valve VPI45)		SSD81...	4861
	Electromotoric actuator, 3-position (for valves 5.5 mm)		SQS85...	4573

2.4 Accessories

Description	Product no.	Data Sheet
Changeover mounting kit (50 pcs / package)	ARG86.3	1840
Adapter plate 120 x 120 mm for 4" x 4" conduit boxes	ARG70	
Adapter plate 112 x 130 mm for surface wiring	ARG70.2	

2.5 Ordering

When ordering, please indicate product no. and description:

RDG400 room thermostat

Order valve actuators separately.

3 Use

The room thermostat is designed for the following types of system:

VAV systems via ON/OFF or modulating control outputs:

- Single-duct system
- Single-duct system with electrical heater
- Single-duct system and radiator / floor heating
- Single-duct system with heating / cooling coil

4 Functions

4.1 Temperature control

General note:

Setting of the control parameters (P01, etc., mentioned throughout the document) is described in section 4.12.

The thermostat acquires the room temperature via built-in sensor, external room temperature sensor (QAA32), or external return air temperature sensor (QAH11.1), and maintains the setpoint by delivering actuator control commands to heating and/or cooling equipment. The following control outputs are available:

- Modulating PI/P control with DC 0...10 V control output
- Modulating PI/P control with 3-position control output
- Modulating PI/P control with PWM output
- On/off control (2-position)





The switching differential or proportional band is 2 K for heating and 1 K for cooling (adjustable via parameters P30 and P31).

The integral action time for modulating PI control is 5 minutes (adjustable via parameter P35).

Display

The display shows the acquired room temperature or the Comfort setpoint, selectable via parameter P06. The factory setting displays the current room temperature. Use parameter P04 to display the room temperature or setpoint in °F rather than °C as needed.



If the thermostat is used in a system with manual heating / cooling changeover (P01 = 2), the heating  and cooling  symbols on the display show the terminal unit's status. Thus, the symbols are displayed even when the thermostat operates in the neutral zone. For all other cases, the heating  and cooling  symbols are displayed when the heating or cooling output is activated.

Concurrent display of °C and °F

Concurrent display of the current temperature or setpoint in °C and °F (parameter P07) is possible.

4.2 Operating modes

Select the thermostat's operating mode via the operating mode button on the unit or operating mode input (e.g. keycard occupancy sensor, when X1, X2, or D1 is set to 3 (P38, P40, P42)). A corresponding setpoint is used to maintain the room temperature at the desired level depending on the active operating mode. The following operating modes are available:

Comfort mode

In Comfort mode, the thermostat maintains the room temperature setpoint which can be adjusted via the **rotary knob**. The fan can be set to automatic or manual fan speed: Low, medium or high.

Energy Saving mode

Energy Saving mode helps save energy. Select it by pressing the operating mode button if parameter P02 is set accordingly, or if the external operating mode switchover contact is active (e.g. window contact).

Note: If the external operating mode switchover contact is active, user operations are ineffective and OFF is displayed. Control will then be according to Energy Saving setpoints (P11 and P12).





Protection mode

In Protection mode, the system is

- protected against frost (factory setting **8 °C**, can be disabled or changed via P65)
- protected against overheating (factory setting **OFF**, can be enabled or changed via P66)

Operating mode button

The behavior of the operating mode button can be selected via parameter P02:

#	Sequence	Remark
1	 → 	Factory setting
2	 →  → 	

4.3 Room temperature Setpoints

Comfort mode

Setpoint limitation

The setpoint in Comfort mode can be adjusted via the **rotary knob**.

For Energy Saving purposes, the setpoint setting range can be limited to minimum (P09) and maximum (P10).

P09 < P10

- If the minimum limit **P09 is set lower** than the maximum limit P10, both heating and cooling are adjustable between these 2 limits.

P09 ≥ P10

- For heating **or** cooling applications (e.g. single-duct; single-duct & H/C coil):
 - The setting range in cooling mode is from **P09...40 °C** in place of 5...40 °C
 - The setting range in heating mode is from **5...P10 °C** in place of 5...40 °C
- For cooling **and** heating with electrical heater or radiator applications:
 - **P09** is the setpoint for cooling and **P10** the setpoint for heating
 - The setpoint can no longer be adjusted via the rotary knob

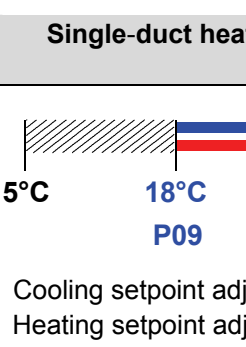
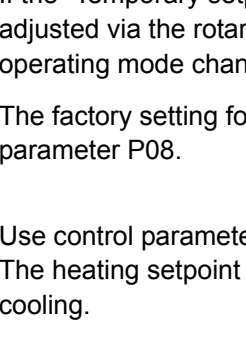
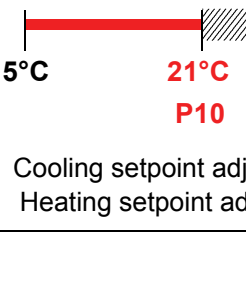
Examples	Single-duct heating or cooling	Single-duct cooling with el. heater / radiator
P09 < P10	 <p>5°C 18°C 25°C 40°C</p> <p> P09 P10</p> <p>Cooling setpoint adjustable 18...25 °C Heating setpoint adjustable 18...25 °C</p>	 <p>5°C 18°C 25°C 40°C</p> <p> P09 P10</p> <p>Cooling setpoint adjustable 18...25 °C Heating setpoint adjustable 18...25 °C</p>
P09 ≥ P10	 <p>5°C 21°C 25°C 40°C</p> <p> P10 P09</p> <p>Cooling setpoint adjustable 25...40 °C Heating setpoint adjustable 5...21 °C</p>	<p>Cooling fixed = 25 °C (P09) Heating fixed = 21 °C (P10)</p>

Temporary setpoint

If the "Temporary setpoint function" is enabled via parameter P69, the setpoint adjusted via the rotary knob is set back to the Comfort basic setpoint when the operating mode changes.

The factory setting for the Comfort basic setpoint is **21 °C** and can be changed via parameter P08.

Energy Saving mode

Use control parameters P11 and P12 to adjust the Energy Saving mode setpoints. The heating setpoint is factory-set to **15 °C** and the cooling setpoint to **30 °C** for cooling.

Protection mode

Use control parameters P65 and P66 to adjust the Protection mode setpoints. The heating setpoint is factory-set to **8 °C** (frost protection) and to **OFF** for cooling.

Caution

If a setpoint is set to OFF (P65, P66), the thermostat does not maintain the setpoint in the corresponding mode (heating or cooling).

This means no protective heating or cooling function and thus risk of frost in the heating mode or risk of overtemperature in cooling mode!

4.4 Setpoints and sequences

On single-duct changeover applications, the Comfort setpoints for heating and cooling sequence are the same (w).

On applications with electrical heater, radiator or heating / cooling coil, the Comfort setpoint is at the heating sequence.

The start of the cooling sequence is linked to "Dead zone" above the Comfort setpoint. The dead zone can be set via parameter P33.

The setpoints for Energy Saving and Protection mode are below the Comfort setpoints (heating) and above the Comfort setpoints (cooling).

They can be set via parameters P11, P12 (Energy Saving mode) and P65, P66 (Protection mode).

The control signal for air flow can be limited via parameters P63 and P64.

See section 4.8.1.

To simplify the diagram below, only minimum limitation is shown.

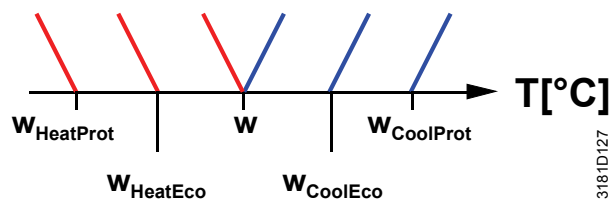

Application	Comfort mode		Energy Saving / Protection mode	
	Heating mode	Cooling mode	Heating mode	Cooling mode
Single-duct				
Single-duct with min/max limitation				

Application	Comfort mode	Energy Saving	Protection mode
Single-duct with electrical heater			
Single-duct with radiator			

Anwendung	Comfort mode		Energy Saving mode	
	Heating mode	Cooling mode	Heating mode	Cooling mode
Single-duct with heating / cooling coil				
	Protection mode		Heating mode	Cooling mode

W = setpoint in Comfort mode

$W_{HeatEco/Prot}$ = setpoint heating in Energy Saving or Protection mode

$W_{CoolEco/Prot}$ = setpoint cooling in Energy Saving or Protection mode

YR = radiator sequence

YE = el. heater sequence

YHC = heating / cooling coil sequence

4.5 Applications overview

The thermostat supports the following applications, which can be **configured via DIP switches** at the rear of the unit. The control output for the **damper** actuator is either DC 0...10 V (factory setting) or 3-position (see parameter P47), and for the **heating / cooling output** ON/OFF, PWM, 3-position or DC 0...10 V.

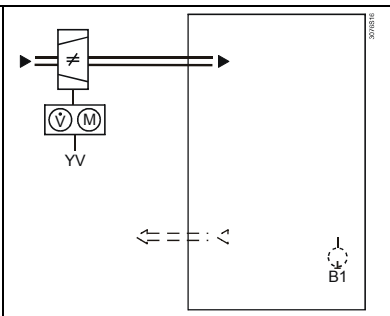
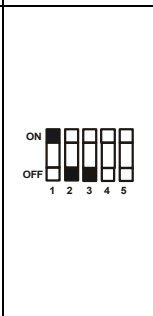
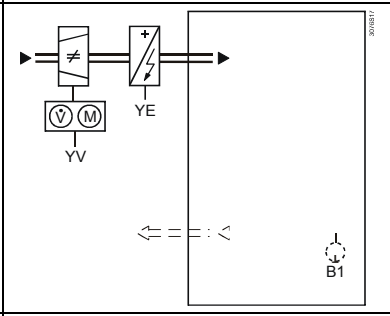
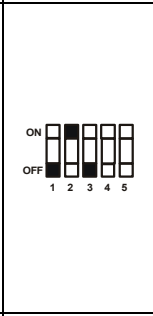
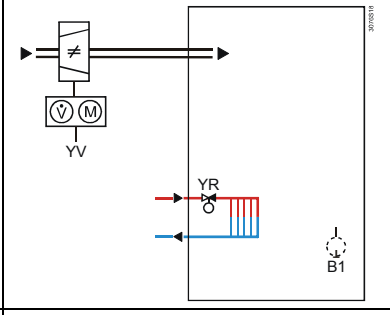
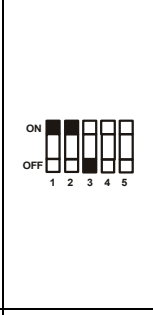
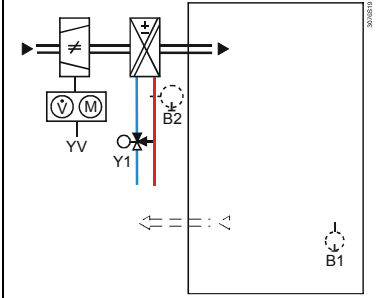
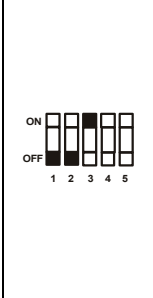
Application (set via DIP switches 1...3)	DIP switch	Control output (set via DIP switches 4 and 5)
Single-duct <ul style="list-style-type: none"> DC 0...10 V damper actuator 3-position damper actuator 		DC 0...10 V 3-position
Single-duct with electrical heater <ul style="list-style-type: none"> DC 0...10 V damper actuator and ON/OFF, PWM or 3-position electrical heater 3-position damper actuator and DC 0...10 V electrical heater 		DC 0...10 V ON/OFF, PWM or 3-position
Single-duct and radiator / floor heating <ul style="list-style-type: none"> DC 0...10 V damper actuator and ON/OFF, PWM or 3-position radiator 3-position damper actuator and DC 0...10 V radiator 		DC 0...10 V ON/OFF, PWM or 3-position
Single-duct heating / cooling coil <ul style="list-style-type: none"> DC 0...10 V damper actuator and ON/OFF, PWM or 3-position heating / cooling 3-position damper actuator and DC 0...10 V heating / cooling 		DC 0...10 V ON/OFF, PWM or 3-position

Key

- Y1 Heating or heating / cooling valve actuator
- YV damper actuator
- YE Electrical heater

- B1 Return air temperature sensor or external room temperature sensor (optional)
- B2 Changeover sensor (optional)

4.6 Additional features

Output signal inversion The output signal DC 0...10V (Y10) can be inverted by means of DIP switch 4 (see section 4.7.3).

Min / Max air flow To ensure a minimum or maximum supply air volume, the output signal for the air flow (DC 0...10 V or 3-position) can be limited to a minimum value via parameter P63 and to a maximum value via parameter P64. Both values can be set between 0% and 100%.

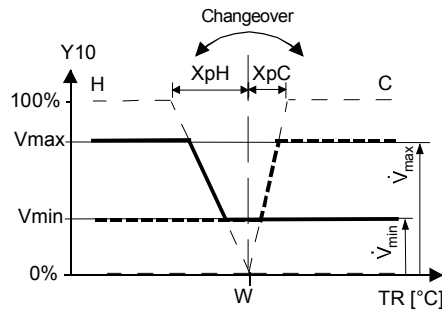

T	Room temperature
Y10	Control output
w	Room temperature setpoint
XpH	Proportional band "Heating"
XpC	Proportional band "Cooling"
Vmin	Minimum limitation air flow
Vmax	Maximum limitation air flow

If Vmin (P63) is set to >0, then a minimum air flow of Vmin is assured in Comfort and Energy Saving modes. In Protection mode, the air flow in dead zone is 0.

Example: air flow rate signal in single duct application with electrical heater:

Comfort or Energy Saving mode with Vmin >0 (P63)

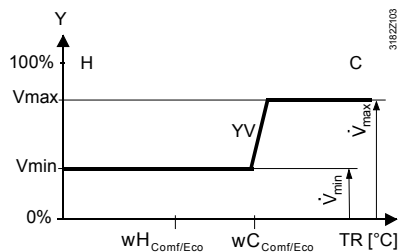

Protection mode with Vmin >0 (P63)

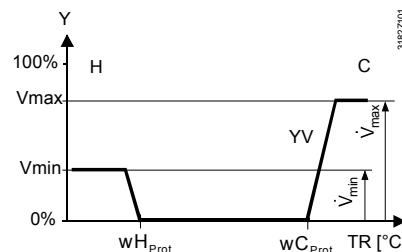

Protection mode (Vmin = 0)
Caution! No air flow when el. heater is active

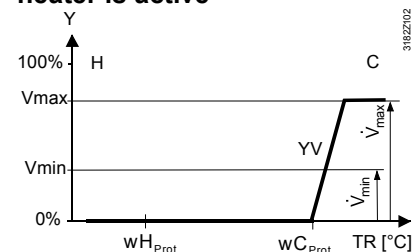

Automatic heating / cooling changeover

The water temperature acquired by the changeover sensor (QAH11.1 + ARG86.3) is used to change over from heating to cooling mode, or vice versa. When the water temperature is above 28 °C (parameter P37), the thermostat changes over to heating mode, and to cooling mode when below 16 °C (parameter P36). If the water temperature is between the 2 changeover points immediately after power-up, the thermostat starts in heating mode. The water temperature is acquired at 30-second intervals and the operating state is updated accordingly.

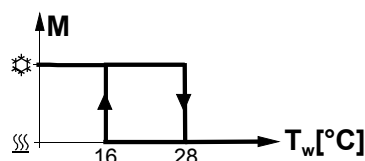

M	Operating mode		Cooling mode
T _w	Water temperature		Heating mode

Remote heating/ cooling changeover

The QAH11.1 cable temperature sensor for automatic heating / cooling changeover can be replaced by an external switch for manual, remote changeover:

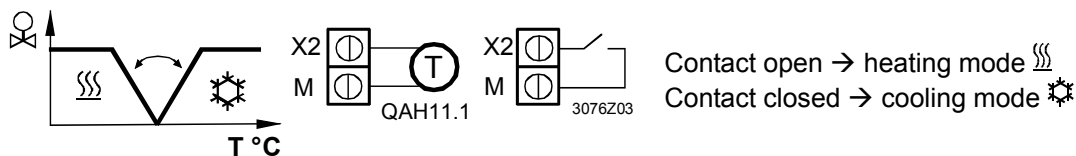

The sensor or switch can be connected to input terminal X2 (factory setting) or X1 or D1 (switch only), depending on the commissioning of the inputs (P38, P40, P42). See also section 4.9 "Multifunctional input".

External / return air temperature sensor

The thermostat acquires the room temperature via built-in sensor, external room temperature sensor (QAA32), or external return air temperature sensor (QAH11.1) connected to multifunctional input X1 or X2. Inputs X1 or X2 must be commissioned accordingly. See section 4.9 "Multifunctional input".

Floor heating

Application "Single-duct and radiator" can also be used for floor heating.

Floor temperature limitation function

The temperature should be limited for 2 reasons: comfort and protection of the floor. It is only available with application "Single-duct and radiator".

The floor temperature sensor, connected to multifunctional input X1 or X2, acquires the floor temperature. If the temperature exceeds the parameterized limit (parameter P51), the heating valve is fully closed until the floor temperature drops to a level 2 K below the parameterized limit.

This function is factory-set to OFF (disabled).

Input X1 or X2 must be commissioned accordingly (P38 or P40 = 1).

See section 4.9 "Multifunctional input".

Recommended values for P51:

Living rooms:

Up to 26 °C for long-term presence, up to 28 °C for short-time presence

Bath rooms:

Up to 28 °C for long-term presence, up to 30 °C for short-time presence

The table below shows the relation between parameter, temperature source and temperature display:

Parameter P51	External temp. sensor available	Source for display of room temperature	Output control according to	Floor temp. limit function
OFF	No	Built-in sensor	Built-in sensor	Not active
OFF	Yes	External temp. sensor	External temp. sensor	Not active
10...50°C	No	Built-in sensor	Built-in sensor	Not active
10...50°C	Yes	Built-in sensor	Built-in sensor + limit by external sensor	Active

Dewpoint monitoring

If the thermostat is used for chilled ceiling, dewpoint monitoring is essential to prevent condensation. It helps avoid associated damage to the building.

A dewpoint sensor with a potential-free contact is connected to multifunctional input X1, X2 or D1. If there is condensation, the cooling valve is fully closed until no more condensation is detected, and the cooling output is disabled temporarily.

The condensation symbol \hat{O} is displayed during temporary override.

The input must be commissioned accordingly (P38, P40, P42).

See section 4.9 "Multifunctional input".

Button lock

If the button lock function is enabled by parameter P14, the buttons will be locked or unlocked by pressing the right button for 3 seconds.

If "Auto lock" is configured, the thermostat will automatically lock the buttons 10 seconds after the last adjustment.

Operating mode switchover contact (window contact)

The thermostat can be forced into Energy Saving mode (e.g. when a window is opened). The window contact can be connected to digital input D1 (or multi-functional input X1, X2). Set parameter P42 (P38, P40) to 3.

Extended Comfort mode (operating mode switchover contact closed)

The left button switches the operating mode from Energy Saving to Comfort for the period preset in P68, if the following conditions are fulfilled:

- The operating mode switchover contact is closed (connected to input X1, X2, D1; parameter P38, P40, P42 set to 3)
- Parameter P68 (extend Comfort period) is greater than 0

During the temporary Comfort mode extension, sandglass symbol  appears.

If parameter P68 (extend Comfort period) = 0, extended Comfort cannot be activated; pressing the left button will show "OFF" (blinking 3 times).

Temporary timer for extension of presence / absence



The current operating mode can be forced temporarily into Comfort or Energy Saving / Protection mode. The time period is adjusted via the rotary knob:

- Extend presence: Set the device to Comfort mode for the selected time period
- Extend absence: Set the device to Energy Saving / Protection mode for the selected time period

To activate the function, keep the left button pressed and, within 3 seconds, turn the rotary knob...







- clockwise for extended presence
- counterclockwise for extended absence

The rotary knob adjusts the time period:

- Extend presence: 0.00...+9:30 in steps of 30 minutes; symbol  appears
- Extend absence: 0.00...-9:30 in steps of 30 minutes; symbol  appears

During the extended presence / absence period, sandglass symbol  appears.

Function

User operating mode selection	Operating mode when activating function	Function	Operating mode during function	Operating mode at end of function
 →  → 	Comfort	Extension	Comfort	Protection
	Comfort	Absence	Protection	Comfort
	Protection	Not available	-	-
 →  → 	Comfort	Extension	Comfort	E-Saving
	Comfort	Absence	E-Saving	Comfort
	E-Saving	Extension	Comfort	E-Saving
	E-Saving	Absence	E-Saving	Comfort
	Protection	Not available	-	-

4.7 Control sequences

4.7.1 Applications and sequences

Application VAV	Sequences
Single-duct	h (\), c (/)
Single-duct & electrical heater	el.h + c (\ /)
Single-duct & radiator	rad + c (\ /),
Single-duct with heat/cool coil	h + c (\ /)

4.7.2 Sequences overview (setting via parameter P01)

The sequence can be set via **parameter P01**, if available.

The thermostats can be used in systems featuring:

- Heating only (P01 = 0)
- Cooling only (P01 = 1)
- Manual heating/cooling changeover (P01 = 2)
- Automatic heating/cooling changeover (P01 = 3)
- Heating and cooling mode (e.g. 4-pipe system) (P01 = 4)

The available modes depend on the application
(selected via DIP switches, see section 4.5).

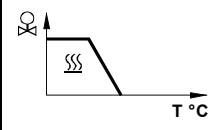
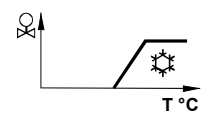
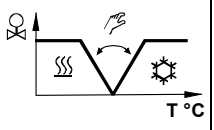
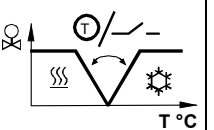
Parameter	P01 = 0	P01 = 1	P01 = 2	P01 = 3
Sequence				
Mode	Heating mode	Cooling mode	Manually select heating or cooling mode	Automatic heating/cooling changeover via external water temperature sensor or remote switch
Available for: ↓				
Single-duct	✓	✓	✓ ¹⁾	✓ ¹⁾
Single-duct & electrical heater	3)	3)	3)	3)
Single-duct & radiator	3)	3)	3)	3)
Single-duct with heat/cool coil	✓	✓	✓ ²⁾	✓ ²⁾

- Notes:
- 1) Changeover air
 - 2) Changeover water; heating / cooling coil
 - 3) The thermostat operates in heating AND cooling mode. P01 is not available

4.7.3 Control outputs configuration (setting via DIP 4 / 5 and parameters P46 / P47)

Application ↓	Control outputs			
	ON/OFF (2-position)	Modulating PWM (2-position)	Modulating 3-position	Modulating DC 0...10 V
Single-duct			✓	✓
Single-duct and electrical heater	✓	✓	✓	✓
Single-duct and radiator / floor heating	✓	✓	✓	✓
Single-duct heating / cooling coil	✓	✓	✓	✓

The function of the control outputs is set via DIP switches 4 and 5:



DIP 4:	Y10 =	DC 0...10 V	DC 0...10 V	DC 10...0 V (inverted)	DC 10...0 V (inverted)
DIP 5:	Y1 / Y2 =	2-position	3-position	2-position	3-position

Note: **Y1, Y2:**

If 2-position is selected, the factory setting is on/off.

If you want PWM (pulse width modulation), set parameter P46 to 2 = PWM.

P47:

- 0 = VAV box DC 0...10 V control signal
- 1 = VAV box: 3-position control signal

For details concerning connection of peripheral devices and setting of the DIP switches, refer to Mounting Instructions M3182 [3].

4.7.4 Single-duct

Single-duct, heating or cooling

On single-duct applications, the thermostat controls an actuator (air damper, VAV system, valve etc.)...

- in heating / cooling mode with changeover (automatic or manual),
- heating only mode,
- or cooling only mode.

Cooling only is factory-set (P01=1).

The output signal for the air flow can be limited to a minimum and maximum value if required (see section 4.6 "Additional features").

Modulating control: 3-position or DC 0...10 V

The diagrams below show the control sequence for modulating PI control.

Heating only (P01 = 0)

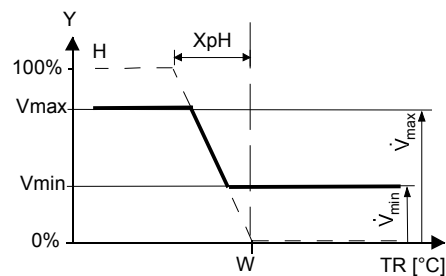

Cooling only (P01 = 1)

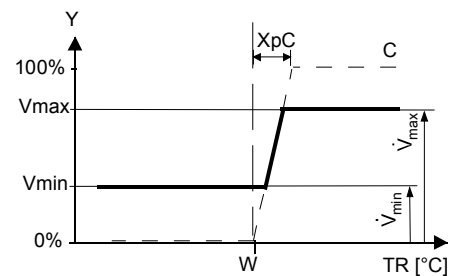

Changeover (P01 = 2, 3)

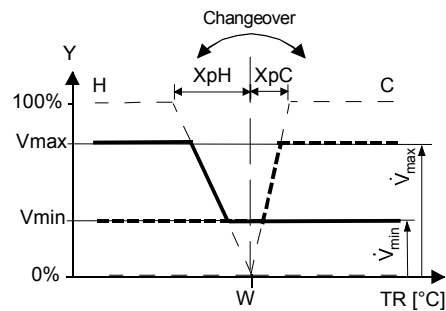

T[°C] Room temperature
w Room temperature setpoint
Y Control command "Actuator"

XpH Proportional band "Heating"
XpC Proportional band "Cooling"
Vmin Min. limitation for output
Vmax Max. limitation for output

Note: The diagrams show the PI controller's proportional part only.

Setting the sequence and the control outputs

Refer to sections 4.5 "Applications", 4.7.1 "Sequences" and 4.7.3 "Outputs".

4.7.5 Single-duct with electrical heater

Single-duct with electrical heater

On single-duct applications with electrical heater, the thermostat controls a valve plus an auxiliary electrical heater. Parameter P01 is not available.

The output signal for the air flow can be limited to a minimum and maximum value if required (see section 4.6 "Additional features").

Electrical heating, active in cooling mode

The air flow starts to rise when the acquired room temperature is above setpoint plus dead zone.

The electrical heater receives an **ON** command when the acquired room temperature drops below setpoint (= setpoint for electrical heater).

Digital input "Enable electrical heater"

Remote enabling / disabling of the electrical heater is possible via input X1, X2, or D1 for overheat protection, tariff regulations, energy savings, etc.

Input X1, X2, or D1 must be commissioned accordingly (parameters P38, P40, P42). See section 4.9 "Multifunctional input".

Caution ⚠

In case of insufficient air flow, the thermostat cannot protect the electrical heater against overtemperature. That is why the electrical heater must feature a separate safety device (thermal cutout).

Sequences

ON/OFF electrical heater

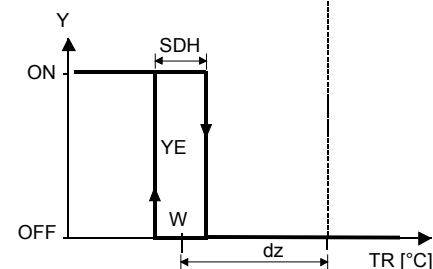
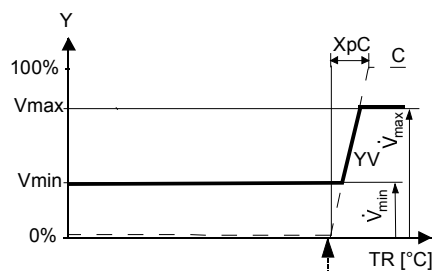

Y Output signal
TR Room temperature
W Effective setpoint Comfort
H Heating sequence
C Cooling sequence
YV Volume flow rate
YE Electrical heater

Modulating electrical heater

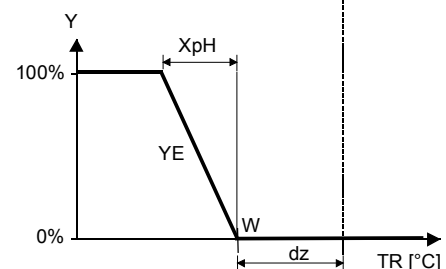
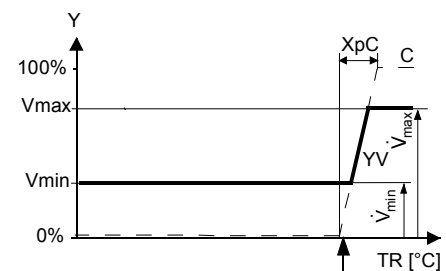

XpH Proportional band heating
XpC Proportional band cooling
Vmin Minimum volume output
Vmax Maximum volume output

Note: The diagrams show the PI controller's proportional part only.

Setting the sequence and the control outputs

Refer to sections 4.5 "Applications", 4.7.1 "Sequences" and 4.7.3 "Outputs".

4.7.6 Single-duct with radiator or floor heating

Single-duct with radiator or floor heating

On single-duct applications with radiator or floor heating, the thermostat controls a valve plus an auxiliary electrical heater. Parameter P01 is not available.

The output signal for the air flow can be limited to a minimum and maximum value if required (see section 4.6 "Additional features").

The air flow starts to rise when the acquired room temperature is above setpoint plus dead zone.

The radiator receives an **ON** command when the acquired room temperature drops below setpoint (= setpoint for radiator).

Note: "Setpoint for radiator" is limited by parameter "Maximum heating setpoint" (P10).

Floor heating

The radiator sequence can also be used for floor heating.

The "Floor heating limitation function" is described on page 16.

Sequences

2-position radiator / floor heating

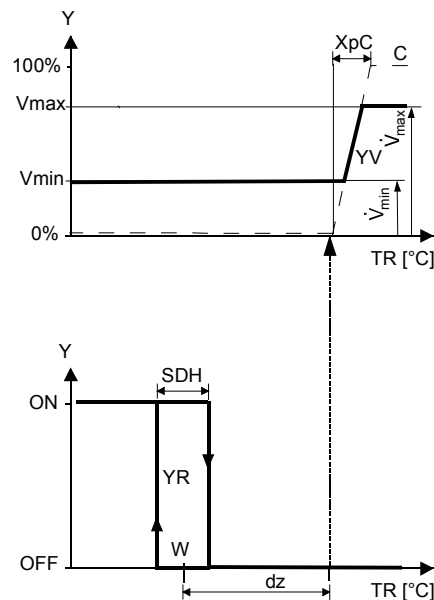

Y Output signal
TR Room temperature
W Effective setpoint Comfort
H Heating sequence
C Cooling sequence
YV Volume flow rate
YR Radiator / floor heating

Modulating radiator / floor heating

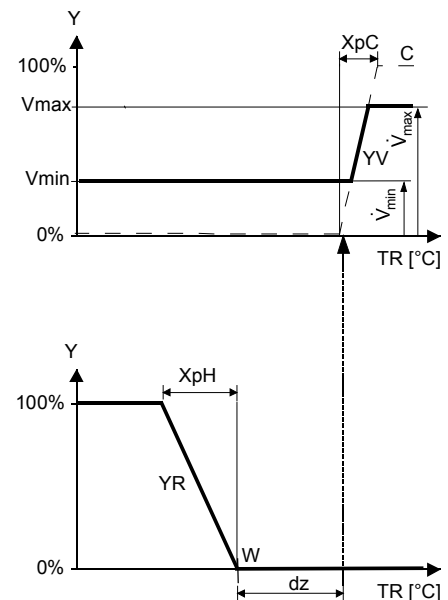

XpH Proportional band heating
XpC Proportional band cooling
Vmin Minimum volume output
Vmax Maximum volume output

Note: The diagrams show the PI controller's proportional part only.

Setting the sequence and the control outputs

Refer to sections 4.5 "Applications", 4.7.1 "Sequences" and 4.7.3 "Outputs".

4.7.7 Single-duct with heating / cooling coil

Single duct with heating / cooling coil

On single-duct applications with heating / cooling coil, the thermostat controls an actuator (air damper, VAV system, etc.) plus a heating / cooling water coil.

The output signal for the air flow can be limited to a minimum and maximum value if required (see section 4.6 "Additional features").

The thermostat controls the reheating / cooling water valve either in heating / cooling mode with changeover (automatic or manual), heating only, or cooling only. Cooling only is factory-set (P01 = 01).

Water coil valve in cooling mode

If the room temperature is above the setpoint for cooling, the valve will receive an **OPEN** command and the air flow signal starts to rise to maintain the room temperature setpoint.

Water coil valve in heating mode

If the room temperature drops below the setpoint for heating, then the valve will receive an **OPEN** command.

Control sequence

The diagrams below show the control sequence for modulating PI control in Comfort mode.

2-position heating / cooling coil

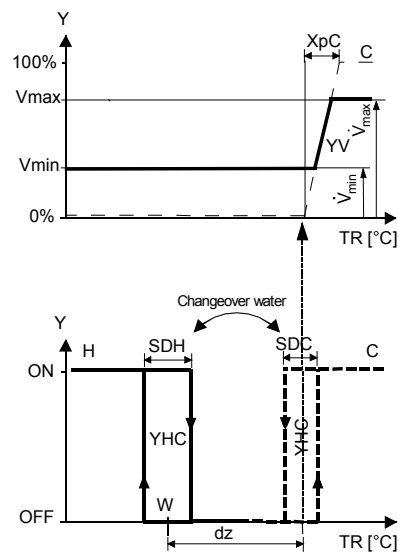

Y Output signal
TR Room temperature
W Comfort setpoint
H Heating sequence
C Cooling sequence
YV Volume flow rate

Modulating heating / cooling coil

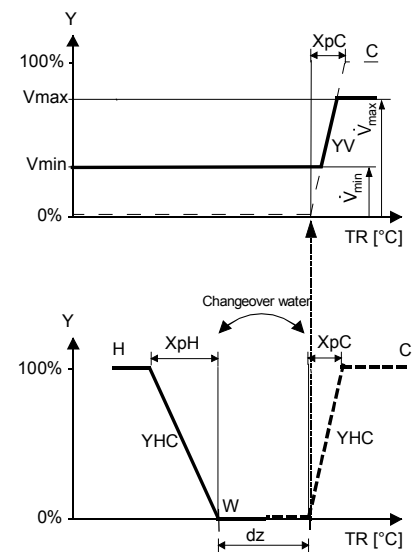

XpH Proportional band heating
XpC Proportional band cooling
Vmin Minimum volume output
Vmax Maximum volume output

Note: The diagrams show the PI controller's proportional part only.

Setting the sequence and the control outputs

Refer to sections 4.5 "Applications", 4.7.1 "Sequences" and 4.7.3 "Outputs".

4.8 Control outputs

Overview of control outputs

Different control output signals are available depending on the configuration of thermostat via DIP switches 4 and 5, and parameters P46 and P47.

Control output Product No.	Modulating DC 0...10 V	2-position on/off	2-position PWM	Modulating 3-position
RDG400	Y10	Y1	Y1	Y1/Y2 (1 x ▲ / ▼)

Configuring of the control outputs: refer to section 4.7.3.

4.8.1 Control output for air flow

DC 0..10 V control signal

The demand calculated by PI control from the current room temperature and setpoint is provided to the valve actuator as a modulating DC 0...10 V signal via output Y10.

3-position control signal

A 3-position control output for an air damper has 2 control signals, one for the “opening” command and one for the “closing” command. The thermostat has an internal stroke model to calculate the position of the actuator. Therefore, the running time from the fully closed to the fully open position must be adjusted via parameter P44 (from 20...300 seconds; factory setting is 150 seconds).

Synchronization

On single-duct applications, a closing synchronization is effected to readjust the internal stroke model to the real position of the actuator.

1. When the thermostat starts up, a closing signal (actuator running time + 150% = 2.5 x running time) is delivered to ensure the actuator will be fully closed and synchronized with the control algorithm.
2. Each time the thermostat calculates the **fully closed** position, the actuator's running time is extended + 150% to ensure the right position of the actuator.
3. When the actuator has reached the position calculated by the thermostat, a waiting time of 30 seconds is observed to stabilize the outputs.

Note: “Opening” synchronization is available for valve outputs only.

4.8.2 Control output for electrical heater, radiator and heating / cooling coil

ON/OFF control signal (2-position)

The valve receives an **OPEN/ON** command via control output Y1 when...

1. the acquired room temperature is below the setpoint (heating mode) or above the setpoint (cooling mode),
2. the control outputs have been inactive for more than the "Minimum output off-time" (factory setting 1 minute, adjustable via parameter P48).

OFF command for valve output when...

1. the acquired room temperature is above the setpoint (heating mode) or below the setpoint (cooling mode),
2. the valve has been active for more than the "Minimum output on-time" (factory setting 1 minute, adjustable via parameter P49).

Electrical heater control signal (2-position)

The electrical heater receives an **ON** command via the auxiliary heating control output (Y1) when...

1. the acquired room temperature is below "setpoint for electric heater",
2. the electrical heater has been switched off for at least 1 minute.

The **OFF** command for the electrical heater is output when...

1. the acquired room temperature is above the setpoint (electric heater),
2. the electrical heater has been switched on for at least 1 minute.

Caution ⚠

A safety thermostat (to prevent overheating) must be provided externally.

DC 0...10 V for electrical heaters

- The demand calculated by PI control from the current room temperature and setpoint is provided via Y10 as a modulating DC 0...10 V signal
- The signal converter (SEM61.4) converts the DC 0...10 V signal to AC 24 V PDM pulses for the current valve
- The current valve (SEA45.1) supplies the electrical heater with AC 50...660 V pulsed current

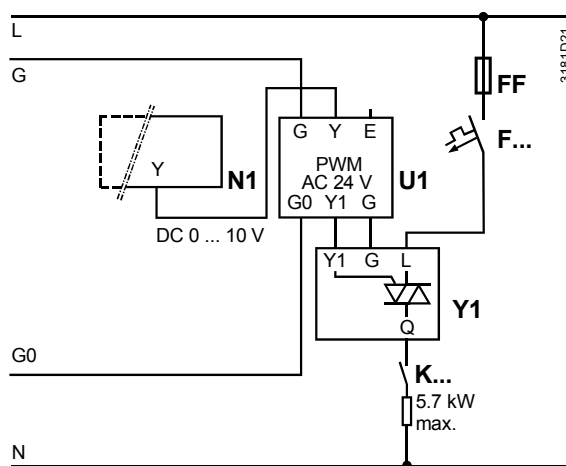

- N1 RDG400
 U1 Signal converter SEM61.4 (see Data Sheet N5102)
 Y1 Current valve SEA45.1 (see Data Sheet N4937)
 K... Safety loop (e.g. safety thermostat and high-temperature cutout)
 FF Very fast-acting fuse
 F... Overcurrent trip

3-position control signal	<p>Output Y1 provides the OPEN command, and Y2 the CLOSE command to the 3-position actuator.</p> <p>The factory setting for the actuator's running time is 150 seconds. It can be adjusted via parameter P44 (Y1 and Y2).</p> <p>The parameter is only visible if 3-position is selected via DIP switch 5.</p>
Synchronization	<ol style="list-style-type: none"> 1. When the thermostat gets powered up, a closing command for the actuator's running time + 150% is provided to ensure that the actuator fully closes and synchronizes to the control algorithm. 2. When the thermostat calculates the positions "fully closed" or "fully open", the actuator's running time is extended + 150% to ensure the right actuator position synchronized to the control algorithm. 3. After the actuator reaches the position calculated by the thermostat, a waiting time of 30 seconds is applied to stabilize the outputs.
PWM control	<p>The demand calculated by PI control from the current room temperature and set-point is provided via Y1 to the valve actuator as a PWM signal (pulse width modulation) for thermal actuators. The output is switched on for a period proportional to the heating / cooling demand and then switched off for the rest of the PWM interval.</p> <p>The interval is 150 seconds (factory setting). It can be adjusted via parameter P44 (Y1). The parameter is only visible if 2-position is selected via DIP switch 5.</p>
PWM for thermic valve actuators	<p>For thermal valve actuators, set the running time to 240 sec.</p> <p>Note!</p> <ul style="list-style-type: none"> • Never apply PWM to a motoric actuator • It is not possible to ensure exact parallel running of more than 2 thermal valve actuators. If several fan coils are driven by the same thermostat, preference should be given to motoric actuators
PWM for el. heaters	<p>For electrical heaters, set the running time to 90 seconds.</p> <p>To avoid burn-off of mechanical contacts by frequent switching, use a current valve in place of a relay or contactor.</p>

4.9 Multifunctional input, digital input

The thermostat has 2 multifunctional inputs X1 and X2 and 1 digital input D1. A sensor type NTC like the QAH11.1 (AI, analog input) or a switch (DI, digital input) can be connected to the input terminals. The functionality of the inputs can be configured via parameters P38 for X1, P40 for X2, and P42 for D1.

#	Function of input	Description	Type X1/X2	Type DI
0	Not used	No function.	--	--
1	External / return air temperature	Sensor input for external room temperature sensor or return air temperature sensor to acquire the current room temperature, or floor heating temperature sensor to limit the heating output. <i>Note:</i> The room temperature is acquired by the built-in sensor if the floor temperature limitation function is enabled via parameter P51.	AI	
2	Heating / cooling changeover	Sensor input for automatic heating / cooling changeover function. A switch can also be connected rather than a sensor (switch closed = cooling, see section 4.6).	AI/(DI)	DI
3	Operating mode switchover	Digital input to switch over the operating mode to Energy Saving. If the operating mode switchover contact is active, user operations are ineffective and "OFF" is displayed.	DI	DI
4	Dewpoint monitor	Digital input for a dewpoint sensor to detect condensation. Cooling is stopped if condensation occurs.	DI	DI
5	Enable electrical heater	Digital input to enable / disable the electrical heater via remote control.	DI	DI
6	Fault	Digital input to signal an external fault (example: el. heater overheat). If the input is active, "ALx" is displayed (Alarm x, with x = 1 for X1, x = 2 for X2, x = 3 for D1). <i>Note:</i> Fault displays do not influence the thermostat's operation. They merely represent a visual signal.	DI	DI

Operational action of the contact can be changed between normally open (NO) and normally closed (NC) via parameter P39, P41 or P43 (if it is a digital input). Each input X1, X2 or D1 must be configured with a different function (1...5). Exception: 1, 2 or 3 inputs can be configured as alarm inputs (6)

X1 is factory-set to "External sensor" (1), X2 to "Heating / cooling changeover" (2), and D1 to operating mode changeover (3).

For more detailed information, refer to section 4.5 "Applications".

4.10 Handling of faults

Temperature out of range

When the room temperature is outside the measuring range, i.e. above 49 °C or below 0 °C, the limiting temperatures blink, e.g. "0 °C" or "49 °C".

The heating output is activated if the current setpoint is not set to "OFF", the thermostat is in heating mode and the temperature is below 0 °C.

For all other cases, no output is activated.

The thermostat resumes Comfort mode after the temperature returns to within the measuring range.

4.11 DIP switches



Use the DIP switches at the rear of the thermostat to commission the thermostat's basic application prior to snapping it to the base.

- The application is set via DIP switches 1...3
- The function of the control outputs (2-position or 3-position, DC 0...10 V) is set via DIP switches 4 and 5

For details concerning connection of peripheral devices and setting of the DIP switches, refer to Mounting Instructions M3182 [3].

Note: During startup, the thermostat reloads the control parameter factory settings after each change of DIP switch setting.

4.12 Control parameters

A number of control parameters can be readjusted to optimize control performance. These parameters can also be set during operation without opening the unit. In the event of a power failure, all control parameter settings are retained.

The control parameters are assigned to 2 levels:

- "Service level", and
- "Expert level" with "Diagnostics and test"

The "Service level" contains a small set of parameters to set up the thermostat for the HVAC system and to adjust the user interface. These parameters can usually be adjusted any time.

Change parameters at the "Expert level" only carefully, as they impact control performance and functionality of the thermostat.

Parameter setting

Enter only "Service level"

Change the parameters as follows:

1. Press left and right button simultaneously for >3 seconds, release them, then press the right button for >3 seconds.
The display shows "P01" (or P02 when P01 is not available).
Continue with step 2.

Enter "Expert level" and "Diagnostics and test"

1. Press left button and right button simultaneously for >3 seconds, release them, press the left button for >3 seconds, then turn the rotary knob counterclockwise min. ½ rotation.
The display shows "Pxx".
Continue with step 2.

Adjusting parameters

2. Select the required parameter by turning the rotary knob.
3. Press button ✓ (OK); the current value of the selected parameter starts blinking and can be changed by turning the rotary knob.
4. Press button ✓ (OK) to confirm the adjusted value or press button ⏏ (Esc) to cancel the change.
5. If you wish to adjust additional parameters, repeat steps 2...4.
6. Press button ⏏ (Esc) to leave the parameter setting mode.

Resetting parameters

The factory setting for the control parameters can be reloaded via parameter P71, by changing the value to "ON". Confirm by pressing the right button.
The display shows "8888" during reloading.

4.12.1 Parameters of the "Service level"







Parameter	Name	Factory setting	Range	RDG400
	Service level			
P01	Control sequence	1 = Cooling only	0 = heating only 1 = cooling only 2 = H/C changeover manually 3 = H/C changeover automatically	✓
P02	Operating mode profile (operating mode button)	1	1 = Comfort - Protection 2 = Comfort - E-saving - Protection	✓
P04	Selection of °C or °F	0 (°C)	0 = degrees Celsius (°C) 1 = degrees Fahrenheit (°F)	✓
P05	Sensor calibration (internally, externally)	0 K	- 3...3 K	✓
P06	Standard temperature display	0	0 = room temperature 1 = setpoint	✓
P07	Display info line (2nd line of LCD)	0	0 = --- (no display) 1 = °C and °F	0..1
P08	Comfort setpoint	21 °C	5...40 °C	✓
P09	Min. setpoint for Comfort mode	5 °C	5...40 °C	✓
P10	Max. setpoint for Comfort mode	35 °C	5...40 °C	✓
P11	Energy Saving heating setpoint	15 °C	OFF, 5 ... WcoolE-saving; (WcoolE-saving = 40 °C max.)	✓
P12	Energy Saving cooling setpoint	30 °C	OFF, WHeatE-saving ... 40 °C; (WHeatE-saving = 5 °C min.)	✓
P14	Button lock function	0	0 = unlocked 1 = auto locked 2 = manual locked	✓

- Note:
- Parameter display depends on selected application and function
 - P01 is available for "Single-duct" and "Single duct & heating / cooling coil" only

4.12.2 Parameters of the "Expert level" with "Diagnostics and test"

Parameter	Name	Factory setting	Range	RDG400
Expert level				
P30	P-band / switching differential in heating mode	2 K	0.5...6 K	✓
P31	P-band / switching differential in cooling mode	1 K	0.5...6 K	✓
P32	P-band / switching differential for radiator	2 K	0.5...6 K	✓
P33	Dead zone in Comfort mode	2 K	0.5...5 K	✓
P34	Setpoint differential (w _D)	2 K	0.5...5 K	✓
P35	Integral action time	5 min	0...10 min	✓
P36	Heating / cooling changeover cooling (X1/X2)	16 °C	10...25 °C	✓
P37	Heating / cooling changeover heating (X1/X2)	28 °C	27...40 °C	✓
P38	Functionality of X1	1 = external sensor	0 = --- (no function) 1 = room temp ext / ret air temp (AI) 2 = H/C changeover (AI/DI) 3 = operating mode contact [DI] 4 = dewpoint sensor (DI) 5 = enable electrical heater (DI) 6 = fault input (DI)	✓ 0..6
P39	Operating action of X1 if digital input	0 (NO)	0 = normally open / open 1 = normally closed / closed	✓
P40	Functionality of X2	2 = H/C changeover	0 = --- (no function) 1 = room temp ext / ret air temp (AI) 2 = H/C changeover (AI/DI) 3 = operating mode contact [DI] 4 = dewpoint sensor. (DI) 5 = enable electrical heater (DI) 6 = fault input (DI)	✓ 0..6
P41	Operating action of X2 if digital input	0 (NO)	0 = normally open / open 1 = normally closed / closed	✓
P42	Functionality of D1	3 = operating mode changeover	0 = --- (no function) 2 = H/C changeover (DI) 3 = operating mode contact [DI] 4 = dewpoint sensor (DI) 5 = enable electrical heater (DI) 6 = fault input (DI)	✓ 0..6
P43	Operating action of D1 if digital input	0 (NO)	0 = normally open / open 1 = normally closed / closed	✓
P44	Running time of Y1/Y2 output (only with modulating PI control)	150 s	20...300 s	✓
P46	Output Y1/Y2 (if not parameterized as 3-pos.)	ON/OFF (1)	1 = 2-position 2 = PWM	✓
P47	Control output for VAV / CAV	0 = 0...10V	0 = 0...10V 1 = 3-position	✓
P51	Floor heating limit temperature	OFF	OFF, 10...50 °C	✓
P63	Minimum output limitation air flow signal	0%	0...P64 (%)	✓
P64	Maximum output limitation air flow signal	100%	P63...100 (%)	✓
P65	Protection heating setpoint	8 °C	OFF, 5...W Cool Prot; (W Cool Prot = 40 °C max.)	✓
P66	Protection cooling setpoint	OFF	OFF, W Heat Prot...40; (W Heat Prot = 5 °C min.)	✓
P68	Extension Comfort period	OFF	OFF; 15...360 min	✓
P69	Temporary setpoint Comfort mode (see also Comfort setpoint P08)	OFF	OFF = disabled ON = enabled	✓
P71	Reload factory settings	OFF	OFF = disabled ON = reload start	✓

Note: P46: Setting to 2-position or 3-position is done with DIP 4

Parameter	Name	Factory setting	Range	RDG400
Diagnostics and test				
d01	Application type	Diagnostics	0 = (No application) 1 = Single-duct 2 = Single-duct with el. heater 3 = Single-duct with radiator / floor heating 4 = Single-duct with H/C coil	✓
d02	X1 status	Diagnostics	0 = not activated (for DI) 1 = activated (DI) 0...49 °C = cur temp value (for AI) 00  = H/C input closed 100  = H/C input open	✓
d03	X2 status	Diagnostics	0 = not activated (for DI) 1 = activated (DI) 0...49 °C = cur temp value (for AI) 00  = H/C input closed 100  = H/C input open	✓
d04	D1 status	Diagnostics	0 = not activated (for DI) 1 = activated (DI) 00  = H/C input closed 100  = H/C input open	✓
d05	Test mode for checking actuator direction Y1/Y2 (press left button to escape)	---	"---" = no signal at outputs Y1 and Y2 OPE = output Y1 forced opening CLO = output Y2 forced closing	✓

5 Handling

5.1 Mounting and installation

Do not mount on a wall in niches or bookshelves, behind curtains, above or near heat sources, or exposed to direct solar radiation. Mount about 1.5 m above the floor.

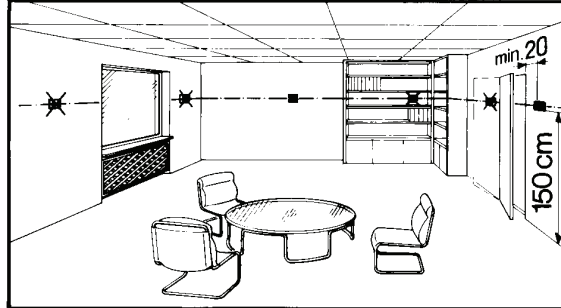

Mounting



- The room thermostat must be mounted in a clean, dry indoor place and must not be exposed to drip or splash water

Wiring



See Mounting Instructions M3182 enclosed with the thermostat.



- Comply with local regulations to wire, fuse and earth the thermostat
- The power supply line must have an external fuse or circuit breaker with a rated current of no more than 10 A
- Inputs X1-M, X2-M or D1-GND of different units (e.g. summer / winter switch) may be connected in parallel with an external switch. Consider overall maximum contact sensing current for switch rating
- Disconnect power supply before removing the thermostat from the mounting plate!

Commissioning

Select the application and type of control output via the DIP switches before fitting the thermostat to the mounting plate.

After power is applied, the thermostat carries out a reset during which all LCD segments blink, indicating that the reset was correct. After the reset, which takes about 3 seconds, the thermostat is ready for commissioning by qualified HVAC staff. The control parameters of the thermostat can be set to ensure optimum performance of the entire system (see Basic Documentation P3182).

Control sequence

- The control sequence may need to be set via parameter P01 depending on the application. The factory setting for the single-duct application (without and with el. heater) is "Cooling only"

Calibrate sensor

- Recalibrate the temperature sensor if the room temperature displayed on the thermostat does not match the room temperature measured. To do this, change parameter P05

Setpoint and setpoint setting range limitation

- We recommend to review the setpoints and setpoint setting ranges (parameters P08...P12) and change them as needed to achieve maximum comfort and save energy

5.2 Operation

See also Operating Instructions B3181 enclosed with the thermostat.

Layout

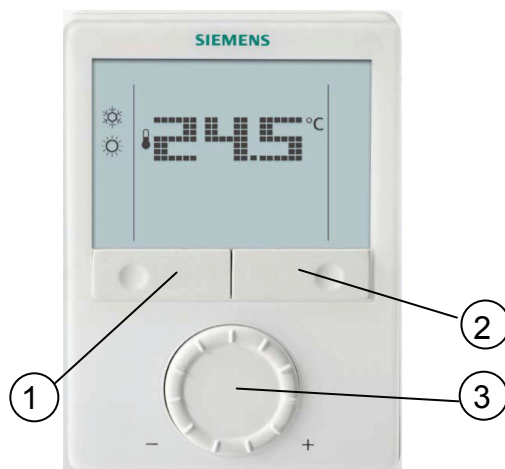

- 1 Operating mode button / Esc
- 2 Protection mode and OK
- 3 Rotary knob for setpoint and parameter adjustment

Button operation

- When the thermostat is in normal operation, the actual operating mode and status are indicated by symbols
- When a button is pressed, the thermostat goes into mode selection. The backlit LCD will turn on, all possible mode selection options (symbols) will turn on, indicator element (arrow) will appear on the current mode / status
- When the button is pressed again, the indicator element will change to the next mode symbol and so on
- After the last press and a timeout of 3 seconds, the newly selected mode is confirmed, the other elements disappear
- After a timeout of 20 seconds, the LCD backlight will turn off

User action	Effect, description
Press left button	Go into Operating mode selection
Press left button for >3 seconds	Set thermostat to Protection mode
Keep left button depressed and turn rotary knob clockwise	Activate temporary timer "Extend presence" and set the time (for details, see page 17)
Keep left button depressed and turn rotary knob counterclockwise	Activate temporary timer "Extend absence" and set the time (for details, see page 17)
Press left button while "Operating mode switchover" is activated	Activate "Extend Comfort mode" (for details, see page 17)
Press right button for >3 seconds	Activate / deactivate button lock
Press right button	Change to Protection mode and back
Turn rotary knob	Adjust the room temperature setpoint
Press left and right button for >3 seconds, release, then press right button for >3 seconds	Go to parameter setting mode Service level
Press left and right button for 3 seconds, release, press left button for 3 seconds, then turn rotary knob counterclockwise min. ½ rotation	Go to parameter setting mode Expert level, diagnostics and test

LCD

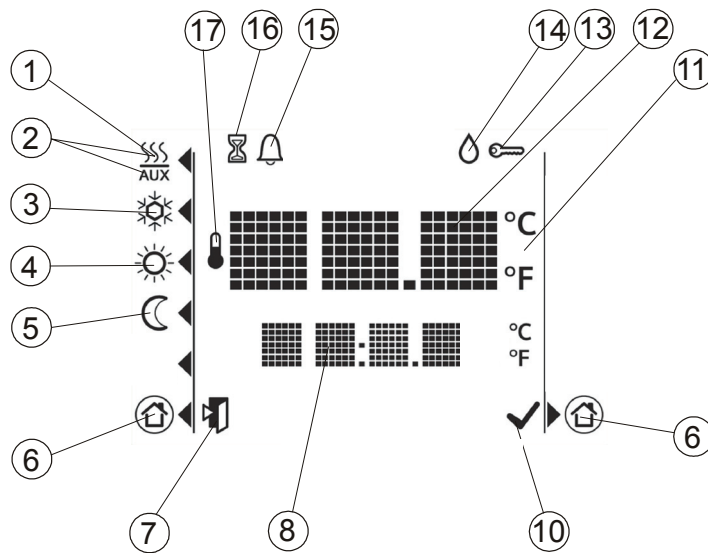

#	Symbol	Description	#	Symbol	Description
1		Heating mode	10		Confirmation of parameters
2		Electrical heater active	11		Degrees Celsius Degrees Fahrenheit
3		Cooling mode	12		Digits for room temperature and setpoint
4		Comfort mode	13		Button lock active
5		Energy Saving mode	14		Condensation in room (dewpoint sensor active)
6		Protection	15		Fault
7		Escape	16		Temporary timer function (visible when operating mode is temporarily extended presence or absence)
8		Digits for room temperature, setpoint, etc.	17		Indicates that room temperature is displayed

5.3 Disposal



The device is classified as waste electronic equipment in terms of the European Directive 2002/96/EC (WEEE) and should not be disposed of as unsorted municipal waste.

The relevant national legal rules are to be adhered to.
Regarding disposal, use the systems setup for collecting electronic waste.

Observe all local and applicable laws.

6 Engineering

6.1 Connection terminals

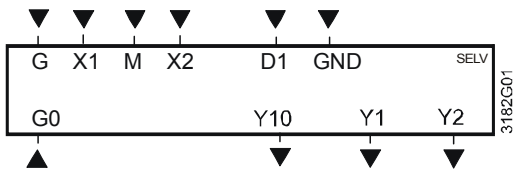

G, G0 Operating voltage AC 24 V

Y10/G0 Control output for DC 0...10 V actuator

Y1/G, Y2/G Control output for 2-position, PWM or 3-position actuators

X1, X2 Multifunctional input for temperature sensor (e.g. QAH11.1) or potential-free switch

Factory setting:

- X1 = external room temperature sensor

- X2 = sensor or switch for automatic heating / cooling changeover

Change of setting: Parameters P38, P40

M Measuring neutral for sensor and switch

D1, GND Multifunctional input for potential-free switch.

Factory setting: Operating mode switchover contact

Change of setting: Parameter P42

6.2 Connection diagrams

Note: For details concerning connection of peripheral devices and setting of the DIP switches, please refer to Mounting Instructions M3182.

Application: Single-duct

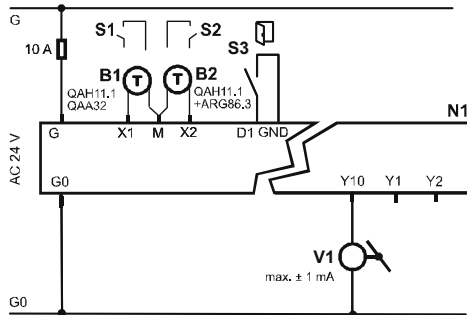

V1 DC 0...10 V damper actuator

N1 Room thermostat RDG400

S1..S3 Switch (keycard, window contact, etc.)

B1, B2 Temperature sensor (return air temperature, external room temperature, changeover sensor, etc.)

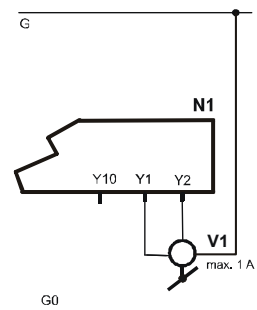

V1 3-position damper actuator

Application: Single-duct with electrical heater, radiator or heating / cooling

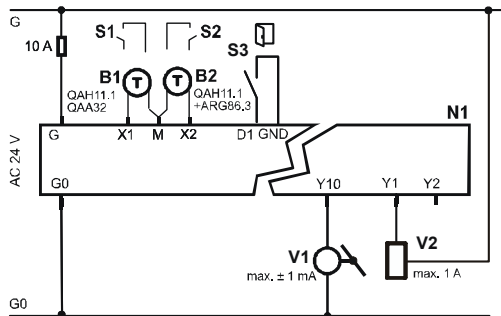

V1 DC 0...10 V damper actuator

V2 2-position or PWM electrical heater, radiator or heating / cooling valve

N1 Room thermostat RDG400

S1..S3 Switch (keycard, window contact, etc.)

B1, B2 Temperature sensor (return air temperature, external room temperature, changeover sensor, etc.)

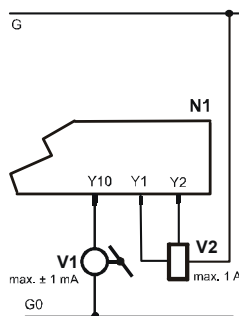

V1 DC 0...10 V damper actuator

V2 3-position electrical heater, radiator or heating / cooling valve

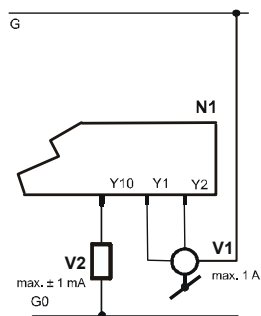

V1 3-position damper actuator

V2 DC 0...10 V electrical heater, radiator or heating / cooling valve

7 Mechanical design

7.1 General

The room thermostat consists of 2 sections:

- Plastic housing which accommodates the electronics, the operating elements and the temperature sensor
- Mounting plate with the screw terminals

The housing engages in the mounting plate and is secured with 2 screws on the left side.



For operation, refer to section 5.2.

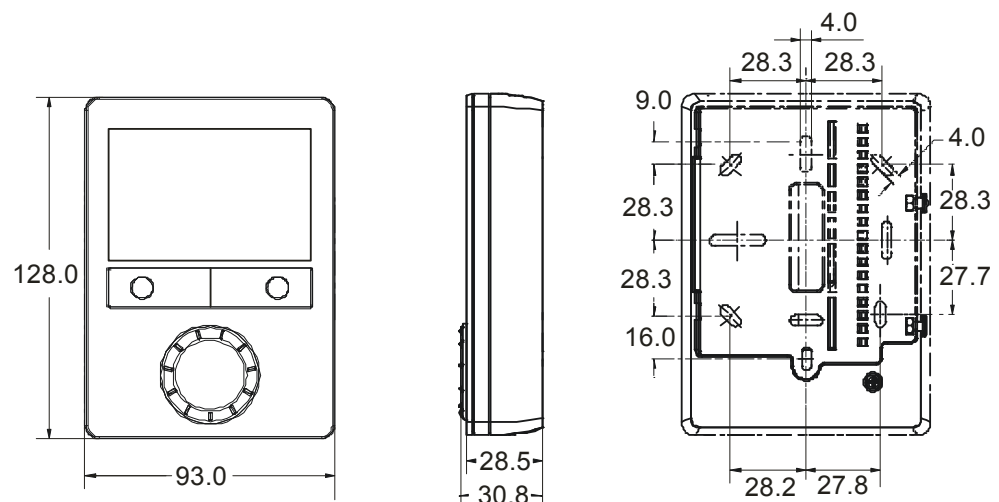

7.2 Dimensions

Dimensions in mm



8 Technical data

⚠ Power supply	Operating voltage	SELV AC 24 V ±20%	
	Frequency	50/60 Hz	
Outputs	Power consumption	Max. 2 VA	
	Control output Y10-G0	DC 0...10 V	
	Resolution	39 mV	
	Current	Max. ±1 mA	
Inputs	Control output Y1, Y2-G	AC 24 V	
	Rating	Max. 1 A	
	Multifunctional inputs, digital input X1-M / X2-M		
	Temperature sensor input		
	Type	QAH11.1 (NTC)	
	Digital input		
	Operating action	Selectable (NO/NC)	
	Contact sensing	DC 0...5 V, max. 5 mA	
	D1-GND		
	Operating action	Selectable (NO/NC)	
Contact sensing	SELV DC 6...15 V, 3...6 mA		
Operational data	Function input	Selectable	
	External temperature sensor, changeover sensor, operating mode switchover contact, dewpoint monitor contact, fault contact		
	Switching differential, adjustable		
	Heating mode	(P30)	2 K (0.5...6 K)
	Cooling mode	(P31)	1 K (0.5...6 K)
	Setpoint setting and range		
	☀ Comfort mode	(P08)	21 °C (5...40 °C)
	☾ Energy Saving mode	(P11-P12)	15 °C / 30 °C (OFF, 5...40 °C)
	🛡 Protection	(P65-P66)	8 °C / OFF (OFF, 5...40 °C)
	Multifunctional inputs X1 / X2, digital input D1	Selectable	
Input X1	Ext. temperature sensor (P38 = 1)		
Input X2	Changeover sensor (P40 = 2)		
Input D1	Operating mode switchover (P42 = 3)		
Built-in room temperature sensor			
Measuring range	0...49 °C		
Accuracy at 25 °C	< ± 0.5 K		
Temperature calibration range	± 3.0 K		
Settings and display resolution			
Setpoints	0.5 °C		
Current temperature value displayed	0.5 °C		

Environmental conditions	Operation	As per IEC 721-3-3
	Climatic conditions	Class 3K5
	Temperature	0...50 °C
	Humidity	<95% r.h.
	Transport	As per IEC 721-3-2
	Climatic conditions	Class 2K3
	Temperature	-25...60 °C
	Humidity	<95% r.h.
	Mechanical conditions	Class 2M2
	Storage	As per IEC 721-3-1
Standards	Climatic conditions	Class 1K3
	Temperature	-25...60 °C
	Humidity	<95% r.h.
	CE conformity	
	EMC directive	2004/108/EC
	 N474 C-tick conformity to	
	EMC emission standard	AS/NSZ 4251.1:1999
	 Reduction of hazardous substances	2002/95/EC
	Product standards	
	Automatic electrical controls for household and similar use	As per EN 60730-1
Special requirements for temperature-dependent controls	As per EN 60730-2-9	
Electronic control type	2.B (micro-disconnection on operation)	
Electromagnetic compatibility		
Emissions	As per IEC/EN 61000-6-3	
Immunity	As per IEC/EN 61000-6-2	
Safety class	III as per EN 60730	
Pollution class	Normal	
Degree of protection of housing	IP30 as per EN 60529	
General	Connection terminals	Solid wires or prepared stranded wires 1 x 0.4...2.5 mm ² or 2 x 0.4...1.5 mm ²
	Housing front color	RAL 9003 white
	Weight	0.350 kg

Index

3		
3-position control signal.....	24	
3-position for air flow	24	
A		
Absence.....	17	
Air flow min / max	15	
Applications	14	
Automatic heating/cooling changeover	15, 18	
B		
Backlit LCD.....	7	
Button lock.....	17	
C		
Comfort mode.....	10	
Control outputs	7	
Control outputs (overview).....	19	
Control parameters.....	29	
Control sequences.....	18	
Cooling mode	18	
D		
DC 0 ... 10 V control signal	24	
DC 0 ... 10 V for air flow.....	24	
DC 0...10 V for el. heaters	25	
Dewpoint monitor.....	27	
Dewpoint monitoring.....	16	
Diagnostics and test	29	
Digital input.....	27	
DIP switches	28	
Disposal	35	
E		
Electrical heater.....	21	
Enable/disable electrical heater	21, 27	
Energy Saving	10	
Expert level parameters.....	29	
Extend Comfort mode.....	17	
Extension of presence / absence	17	
External/Return air temp.	27	
External/return air temperature sensor.....	16	
F		
Fault.....	27	
Fault, handling.....	28	
Floor heating.....	16	
Floor temperature limitation function	16	
H		
Heating /cooling changeover.....	27	
Heating mode	18	
I		
Integral action time.....	9	
L		
LCD	35	
LCD, backlit.....	7	
M		
Manually select heating or cooling mode.....	18	
Min / max air flow	15	
Mounting and installation	33	
Multifunctional inputs.....	27	
O		
On/off control signal	24	
Operating mode button	10	
Operating mode input.....	10	
Operating mode switchover	27	
Operating voltage	7	
Output signal inversion.....	15	
P		
Parameter setting	29	
Presence	17	
Proportional band.....	9	
Protection mode / Standby.....	10	
PWM.....	24	
PWM for el. heater	26	
R		
Radiator.....	22	
Remote heating/ cooling changeover	16	
Resetting parameters.....	29	
S		
Sensor input	27	
Sequences	18	
Service level parameters.....	29	
Setpoint Comfort	12	
Setpoint Energy Saving.....	12	
Setpoint limitation	11	
Setpoint Protection.....	12	
Setpoints and sequences.....	12	
Standby / Protection mode.....	10	
Switching differential	9	
Synchronization.....	24, 26	
T		
Temperature out of range.....	28	
Temporary setpoint.....	11	
W		
Window contact.....	17	

Siemens Switzerland Ltd
Building Technologies Division
International Headquarters
Gubelstrasse 22
CH-6301 Zug
Tel. +41 41-724 24 24
Fax +41 41-724 35 22
www.buildingtechnologies.siemens.com

© 2009 Siemens Switzerland Ltd
Subject to change