

HC / HCA



SHORT CASED VARIABLE PITCH BLADES FAN

MANUFACTURING FEATURES:

- Plate axial fan with circular reinforced frame.
- Motor-impeller modular assembly for complete versatility.
- Epoxy powder finishing coat.
- Standard asynchronous squirrel-cage motor with IP-55 protection and Class F insulation. Manufactured with standard voltages: 230V 50Hz in single phase motors and 230/400V 50Hz in three phase motors up to 4kW and 400/690V 50Hz for higher powers.
- HC: Polyamide impeller with variable pitch angle reinforced with fiberglass
- HCA: Cast aluminum impeller with variable pitch angle.

APPLICATIONS:

Designed for wall or duct installation, they are suitable for:

- Air renewal in buildings and industries.
- Smoke exhaust (maximum 50-60°C).
- Maximum working temperature: 50°C single phase, 60°C three phase.

ACCESSORIES



INT



CPM



EASY
KPE



PO



RP1



RP



AC



BA-400



PC2



SIL-C /
SIL-CN



PCP



SFC

UNDER REQUEST:

- Supply impeller (air direction from impeller to motor), 100% reversible impeller.
- 60Hz fans and special voltages.
- Hot-dipped galvanized or stainless steel housing.
- Optional can be adapted an square plate to the frame, to transform it in an axial square frame version fan.

TECHNICAL DATA

SINGLE-PHASE MOTOR / 2 poles

Code	Model	R.P.M.	Rated I. (A) 230V	Rated power kW	Max. Airflow m3/h	Sound db (A)*	Weight Kg	Connect. diagram
26236306__P	HC 35 M2 0,55kW (A0:6)	2800	3,71	0,55	4.690	59	14	1
26239306__P	HC 35 M2 1,1kW (A0:6)	2800	6,71	1,1	5.760	57	14	1

SINGLE-PHASE MOTOR / 4 poles

Code	Model	R.P.M.	Rated I. (A) 230V	Rated power kW	Max. Airflow m3/h	Sound db (A)*	Weight Kg	Connect. diagram
26235306__P	HC 35 M4 0,12kW (A0:6)	1380	1,15	0,12	3.100	42	10	1
26240306__P	HC 40 M4 0,25kW (A0:6)	1400	1,93	0,25	4.690	48	16	1
26243306__P	HC 45 M4 0,37kW (A0:6)	1400	2,82	0,37	6.605	53	17	1
26250306__P	HC 50 M4 0,55kW (A0:6)	1400	3,98	0,55	9.320	52	24	1
26257356__P	HC 56 M4 0,37kW (A5:6)	1400	2,82	0,37	7.230	58	46	1
26258326__P	HC 56 M4 0,55kW (A2:6)	1400	3,98	0,55	8.290	56	48	1
26258356__P	HC 56 M4 0,55kW (A5:6)	1400	3,98	0,55	8.680	58	48	1

SINGLE-PHASE MOTOR / 6 poles

Code	Model	R.P.M.	Rated I. (A) 230V	Rated power kW	Max. Airflow m3/h	Sound db (A)*	Weight Kg	Connect. diagram
26243306__P	HC 40 M6 0,04kW (A0:6)	920	0,6	0,04	2.760	36	12	1
26249306__P	HC 45 M6 0,13kW (A0:6)	920	1,3	0,13	4.710	41	14	1
26252306__P	HC 50 M6 0,13kW (A0:6)	920	1,3	0,13	6.040	43	22	1
26256326__P	HC 56 M6 0,25kW (A2:6)	870	2,42	0,25	7.710	47	46	1
26256356__P	HC 56 M6 0,25kW (A5:6)	870	2,42	0,25	7.700	50	46	1
26257326__P	HC 56 M6 0,37kW (A2:6)	890	2,9	0,37	9.000	46	46	1
26257356__P	HC 56 M6 0,37kW (A5:6)	890	2,9	0,37	8.770	48	46	1
26263356__P	HC 63 M6 0,37kW (A5:6)	890	2,9	0,37	10.760	49	49	1
26262329__P	HC 63 M6 0,55kW (A2:9)	890	3,9	0,55	11.900	51	54	1
26262356__P	HC 63 M6 0,55kW (A5:6)	890	3,9	0,55	12.050	50	50	1
26271326__P	HC 71 M6 0,55kW (A2:6)	890	3,9	0,55	15.500	53	53	1
26271329__P	HC 71 M6 0,55kW (A2:9)	890	3,9	0,55	12.700	56	53	1

THREE-PHASE MOTOR / 2 poles

Code	Model	R.P.M.	Rated I. (A) 400V	Rated power kW	Max. Airflow m3/h	Sound db (A)*	Weight Kg	Connect. diagram
26236606__P	HC 35 T2 0,55kW (A0:6)	2800	1,29	0,55	4.690	59	14	2
26239606__P	HC 35 T2 1,1kW (A0:6)	2800	2,33	1,1	5.760	57	14	2
26242306__P	HC 40 T2 1,1kW (A0:6)	2800	2,33	1,1	7.850	61	22	2
26246606__P	HC 45 T2 1,5kW (A0:6)	2800	3,14	1,5	9.560	68	25	2
26248606__P	HC 45 T2 2,2kW (A0:6)	2800	4,58	2,2	12161,5	63	28	2

THREE-PHASE MOTOR / 4 poles

Code	Model	R.P.M.	Rated I. (A) 400V	Rated power kW	Max. Airflow m3/h	Sound db (A)*	Weight Kg	Connect. diagram
26235606__P	HC 35 T4 0,12kW (A0:6)	1400	0,46	0,12	3.100	42	10	2
26240606__P	HC 40 T4 0,25kW (A0:6)	1400	0,79	0,25	4.690	48	16	2
26247606__P	HC 45 T4 0,55kW (A0:6)	1400	1,49	0,55	7.260	50	17	2
26250606__P	HC 50 T4 0,55kW (A0:6)	1400	1,49	0,55	9.320	52	24	2
26257656__P	HC 56 T4 0,37kW (A5:6)	1400	1,07	0,37	7.230	58	46	2
26258626__P	HC 56 T4 0,55kW (A2:6)	1400	1,49	0,55	8.290	56	48	2
26258629__P	HC 56 T4 0,55kW (A2:9)	1400	1,49	0,55	6.590	56	51	2
26258656__P	HC 56 T4 0,55kW (A5:6)	1400	1,49	0,55	8.680	58	48	2
26259626__P	HC 56 T4 0,75kW (A2:6)	1390	1,63	0,75	10.500	55	49	2
26259629__P	HC 56 T4 0,75kW (A2:9)	1390	1,63	0,75	8.170	56	50	2
26259656__P	HC 56 T4 0,75kW (A5:6)	1390	1,63	0,75	10.810	59	49	2
26260626__P	HC 56 T4 1,1kW (A2:6)	1400	2,49	1,1	12.900	55	50	2
26260629__P	HC 56 T4 1,1kW (A2:9)	1400	2,49	1,1	11.700	57	53	2
26260656__P	HC 56 T4 1,1kW (A5:6)	1400	2,49	1,1	12.520	56	50	2
26261626__P	HC 56 T4 1,5kW (A2:6)	1400	3,26	1,5	13.900	56	53	2
26261629__P	HC 56 T4 1,5kW (A2:9)	1400	3,26	1,5	13.600	57	55	2
26261656__P	HC 56 T4 1,5kW (A5:6)	1400	3,26	1,5	13.560	57	52	2
26264626__P	HC 63 T4 0,55kW (A2:6)	1400	1,49	0,55	9.020	54	50	2
26265626__P	HC 63 T4 0,75kW (A2:6)	1390	1,63	0,75	11.400	57	51	2
26265629__P	HC 63 T4 0,75kW (A2:9)	1390	1,63	0,75	9.120	59	55	2
26265656__P	HC 63 T4 0,75kW (A5:6)	1390	1,63	0,75	12.020	60	51	2
26266626__P	HC 63 T4 1,1kW (A2:6)	1400	2,49	1,1	15.000	57	55	2
26266629__P	HC 63 T4 1,1kW (A2:9)	1400	2,49	1,1	11.700	59	59	2
26266656__P	HC 63 T4 1,1kW (A5:6)	1400	2,49	1,1	14.740	61	55	2
26267626__P	HC 63 T4 1,5kW (A2:6)	1400	3,26	1,5	18.300	57	57	2
26267629__P	HC 63 T4 1,5kW (A2:9)	1400	3,26	1,5	15.700	60	61	2
26267656__P	HC 63 T4 1,5kW (A5:6)	1400	3,26	1,5	16.610	59	57	2

Code	Model	R.P.M.	Rated I. (A) 400V	Rated power kW	Max. Airflow m3/h	Sound db (A)*	Weight Kg	Connect. diagram
26268626__P	HC 63 T4 2,2kW (A2:6)	1430	4,64	2,2	20.100	58	58	2
26268629__P	HC 63 T4 2,2kW (A2:9)	1430	4,64	2,2	20.300	60	62	2
26268656__P	HC 63 T4 2,2kW (A5:6)	1430	4,64	2,2	18.630	59	58	2
26269629__P	HC 63 T4 3kW (A2:9)	1430	6,17	3	21.800	60	63	2
26272626__P	HC 71 T4 0,75KW (A2:6)	1390	1,63	0,75	12.000	63	57	2
26272656__P	HC 71 T4 0,75kW (A5:6)	1390	1,63	0,75	13.630	65	58	2
26273626__P	HC 71 T4 1,1kW (A2:6)	1400	2,49	1,1	15.500	62	60	2
26273629__P	HC 71 T4 1,1kW (A2:9)	1400	2,49	1,1	12.100	65	62	2
26273656__P	HC 71 T4 1,1kW (A5:6)	1400	2,49	1,1	16.800	64	60	2
26274626__P	HC 71 T4 1,5kW (A2:6)	1400	3,26	1,5	20.800	61	62	2
26274629__P	HC 71 T4 1,5kW (A2:9)	1400	3,26	1,5	15.700	64	64	2
26274656__P	HC 71 T4 1,5kW (A5:6)	1400	3,26	1,5	19.960	63	62	2
26275626__P	HC 71 T4 2,2kW (A2:6)	1430	4,64	2,2	25.300	60	67	2
26275629__P	HC 71 T4 2,2kW (A2:9)	1430	4,64	2,2	21.600	63	68	2
26275656__P	HC 71 T4 2,2kW (A5:6)	1430	4,64	2,2	23.200	62	67	2
26276626__P	HC 71 T4 3kW (A2:6)	1430	6,17	3	27.900	60	69	2
26276629__P	HC 71 T4 3kW (A2:9)	1430	6,17	3	25.300	63	71	2
26276656__P	HC 71 T4 3kW (A5:6)	1430	6,17	3	25.160	65	69	2
26281626__P	HC 80 T4 1,1KW (A2:6)	1400	2,49	1,1	15.400	63	58	2
26282626__P	HC 80 T4 1,5KW (A2:6)	1400	3,26	1,5	20.300	63	62	2
26282629__P	HC 80 T4 1,5KW (A2:9)	1400	3,26	1,5	16.200	71	63	2
26283626__P	HC 80 T4 2,2kW (A2:6)	1430	4,64	2,2	27.900	63	71	2
26283629__P	HC 80 T4 2,2kW (A2:9)	1430	4,64	2,2	21.200	69	74	2
26284626__P	HC 80 T4 3kW (A2:6)	1430	6,17	3	32.500	63	75	2
26284629__P	HC 80 T4 3kW (A2:9)	1430	6,17	3	26.400	68	78	2
26284656__P	HC 80 T4 3kW (A5:6)	1430	6,17	3	31.090	68	75	2
26285626__P	HC 80 T4 4kW (A2:6)	1440	8,32	4	36.100	62	86	2
26285629__P	HC 80 T4 4kW (A2:9)	1440	8,32	4	31.900	67	88	2
26285656__P	HC 80 T4 4kW (A5:6)	1440	8,32	4	34.000	65	86	2
26286626__P	HC 80 T4 5,5kW (A2:6)	1440	10,5	5,5	39.000	62	88	2
26286629__P	HC 80 T4 5,5kW (A2:9)	1440	10,5	5,5	38.200	65	91	2
26293663__P	HC 90 T4 3kW (A6:3)	1430	6,17	3	30.700	63	86	2
26294663__P	HC 90 T4 4kW (A6:3)	1440	8,32	4	37.700	66	97	2
26295663__P	HC 90 T4 5,5kW (A6:3)	1440	10,5	5,5	41.400	68	101	2
26295666__P	HC 90 T4 5,5kW (A6:6)	1440	10,5	5,5	33.400	71	105	2
26296663__P	HC 90 T4 7,5kW (A6:3)	1440	14,1	7,5	45.700	69	113	2
26296666__P	HC 90 T4 7,5kW (A6:6)	1440	14,1	7,5	40.800	72	118	2
26297663__P	HC 90 T4 11kW (A6:3)	1460	21,2	11	49.700	71	154	2
26297666__P	HC 90 T4 11kW (A6:6)	1460	21,2	11	48.700	73	158	2

Code	Model	R.P.M.	Rated I. (A) 400V	Rated power kW	Max. Airflow m3/h	Sound db (A)*	Weight Kg	Connect. diagram
26298666__P	HC 90 T4 15kW (A6:6)	1460	29,8	15	56.500	70	178	2
26214663__P	HC 100 T4 5,5kW (A6:3)	1440	10,5	5,5	48.700	69	114	2
26215663__P	HC 100 T4 7,5kW (A6:3)	1440	14,1	7,5	55.500	68	128	2
26215666__P	HC 100 T4 7,5kW (A6:6)	1440	14,1	7,5	44.200	76	131	2
26216663__P	HC 100 T4 11kW (A6:3)	1460	21,2	11	63.000	70	168	2
26216666__P	HC 100 T4 11kW (A6:6)	1460	21,2	11	56.200	77	173	2
26217663__P	HC 100 T4 15kW (A6:3)	1460	29,8	15	67.100	72	194	2
26217666__P	HC 100 T4 15kW (A6:6)	1460	29,8	15	63.500	76	197	2
26218666__P	HC 100 T4 18,5kW (A6:6)	1465	35,6	18,5	71.200	73	237	2
26219666__P	HC 100 T4 22kW (A6:6)	1470	40,1	22	78.300	75	246	2
26223663__P	HC 112 T4 5,5kW (A6:3)	1440	10,5	5,5	52.700	73	135	2
26224663__P	HC 112 T4 7,5kW (A6:3)	1440	14,1	7,5	63.400	74	145	2
26225663__P	HC 112 T4 11kW (A6:3)	1460	21,2	11	72.600	74	182	2
26225666__P	HC 112 T4 11kW (A6:6)	1460	21,2	11	55.700	78	188	2
26226663__P	HC 112 T4 15kW (A6:3)	1460	29,8	15	83.600	73	203	2
26226666__P	HC 112 T4 15kW (A6:6)	1460	29,8	15	72.700	78	208	2
26227663__P	HC 112 T4 18,5kW (A6:3)	1465	35,6	18,5	87.300	74	240	2
26227666__P	HC 112 T4 18,5kW (A6:6)	1465	35,6	18,5	77.900	77	245	2
26228663__P	HC 112 T4 22kW (A6:3)	1470	40,1	22	89.800	74	241	2
26228666__P	HC 112 T4 22kW (A6:6)	1470	40,1	22	88.400	76	246	2
26229666__P	HC 112 T4 30kW (A6:6)	1475	56,3	30	104.000	78	292	2
27206674__P	HC 125 T4 11kW (A7:4)	1460	21,2	11	71.400	83	207	2
27207674__P	HC 125 T4 15kW (A7:4)	1460	29,8	15	85.800	81	230	2
27207678__P	HC 125 T4 15kW (A7:8)	1460	29,8	15	66.300	89	235	2
27208674__P	HC 125 T4 18,5kW (A7:4)	1465	35,6	18,5	99.200	78	275	2
27208678__P	HC 125 T4 18,5kW (A7:8)	1465	35,6	18,5	73.800	87	278	2
27209674__P	HC 125 T4 22kW (A7:4)	1470	40,1	22	105.000	75	272	2
27209678__P	HC 125 T4 22kW (A7:8)	1470	40,1	22	81.800	86	279	2
27210674__P	HC 125 T4 30kW (A7:4)	1475	56,3	30	117.000	75	323	2
27210678__P	HC 125 T4 30kW (A7:8)	1475	56,3	30	99.200	85	330	2
27211674__P	HC 125 T4 37kW (A7:4)	1475	69,2	37	127.000	76	408	2
27212678__P	HC 125 T4 37kW (A7:8)	1475	69,2	37	114.000	82	455	2
27212678__P	HC 125 T4 45kW (A7:8)	1475	80,7	45	129.000	79	455	2

THREE-PHASE MOTOR / 6 poles

Code	Model	R.P.M.	Rated I. (A) 400V	Rated power kW	Max. Airflow m3/h	Sound db (A)*	Weight Kg	Connect. diagram
------	-------	--------	-------------------	----------------	-------------------	---------------	-----------	------------------



Code	Model	R.P.M.	Rated I. (A) 400V	Rated power kW	Max. Airflow m3/h	Sound db (A)*	Weight Kg	Connect. diagram
26244606__P	HC 40 T6 0,12kW (A0:6)	850	0,62	0,12	2.760	36	17	2
26249606__P	HC 45 T6 0,13kW (A0:6)	920	0,41	0,13	4.710	41	19	2
26252606__P	HC 50 T6 0,13kW (A0:6)	920	0,41	0,13	6.040	43	22	2
26256656__P	HC 56 T6 0,25kW (A5:6)	900	0,92	0,25	7.700	50	46	2
26257656__P	HC 56 T6 0,37kW (A5:6)	900	1,27	0,37	8.770	48	46	2
26254626__P	HC 56 T6 0,55kW (A2:6)	900	1,8	0,55	9.000	47	46	2
26254629__P	HC 56 T6 0,55kW (A2:9)	900	1,8	0,55	9.510	48	50	2
26263656__P	HC 63 T6 0,37kW (A5:6)	900	1,27	0,37	10.760	49	49	2
26262626__P	HC 63 T6 0,55kW (A2:6)	900	1,8	0,55	13.000	49	51	2
26262629__P	HC 63 T6 0,55kW (A2:9)	900	1,8	0,55	11.900	51	54	2
26262656__P	HC 63 T6 0,55kW (A5:6)	900	1,8	0,55	12.050	50	50	2
26265629__P	HC 63 T6 0,75kW (A2:9)	910	1,95	0,75	14.100	50	55	2
26271626__P	HC 71 T6 0,55kW (A2:6)	900	1,8	0,55	15.500	53	53	2
26271629__P	HC 71 T6 0,55kW (A2:9)	900	1,8	0,55	12.700	56	55	2
26272626__P	HC 71 T6 0,75kW (A2:6)	910	1,95	0,75	18.100	51	53	2
26272629__P	HC 71 T6 0,75kW (A2:9)	910	1,95	0,75	16.400	53	55	2
26272656__P	HC 71 T6 0,75kW (A5:6)	910	1,95	0,75	16.250	57	54	2
26273629__P	HC 71 T6 1,1kW (A2:9)	910	2,78	1,1	19.600	53	58	2
26280626__P	HC 80 T6 0,75kW (A2:6)	910	1,95	0,75	19.500	54	65	2
26280629__P	HC 80 T6 0,75kW (A2:9)	910	1,95	0,75	17.100	61	67	2
26280656__P	HC 80 T6 0,75kW (A5:6)	910	1,95	0,75	18.300	59	65	2
26281626__P	HC 80 T6 1,1kW (A2:6)	910	2,78	1,1	23.400	53	67	2
26281629__P	HC 80 T6 1,1kW (A2:9)	910	2,78	1,1	20.700	57	70	2
26281656__P	HC 80 T6 1,1kW (A5:6)	910	2,78	1,1	20.550	57	67	2
26282626__P	HC 80 T6 1,5kW (A2:6)	940	3,71	1,5	25.300	53	69	2
26282629__P	HC 80 T6 1,5kW (A2:9)	940	3,71	1,5	24.800	56	71	2
26282656__P	HC 80 T6 1,5kW (A5:6)	940	3,71	1,5	22.970	56	68	2
26283629__P	HC 80 T6 2,2kW (A2:9)	940	5,94	2,2	27.100	55	72	2
26283656__P	HC 80 T6 2,2kW (A5:6)	940	5,94	2,2	25.190	56	70	2
26291663__P	HC 90 T6 1,5kW (A6:3)	940	3,71	1,5	26.800	58	77	2
26291666__P	HC 90 T6 1,5kW (A6:6)	940	3,71	1,5	23.500	62	80	2
26292663__P	HC 90 T6 2,2kW (A6:3)	940	5,94	2,2	31.100	61	82	2
26292666__P	HC 90 T6 2,2kW (A6:6)	940	5,94	2,2	28.100	63	85	2
26293663__P	HC 90 T6 3kW (A6:3)	960	7,3	3	32.200	61	99	2
26293666__P	HC 90 T6 3kW (A6:6)	960	7,3	3	33.400	62	103	2
26294666__P	HC 90 T6 4kW (A6:6)	960	9,46	4	36.600	61	109	2
26210663__P	HC 100 T6 1,5kW (A6:3)	940	3,71	1,5	31.500	60	94	2
26211663__P	HC 100 T6 2,2kW (A6:3)	940	5,94	2,2	37.900	59	96	2
26211666__P	HC 100 T6 2,2kW (A6:6)	940	5,94	2,2	31.300	67	102	2

Code	Model	R.P.M.	Rated I. (A) 400V	Rated power kW	Max. Airflow m3/h	Sound db (A)*	Weight Kg	Connect. diagram
26212663__P	HC 100 T6 3kW (A6:3)	960	7,3	3	40.800	61	113	2
26212666__P	HC 100 T6 3kW (A6:6)	960	7,3	3	36.400	67	120	2
26213663__P	HC 100 T6 4kW (A6:3)	960	9,46	4	43.500	62	123	2
26213666__P	HC 100 T6 4kW (A6:6)	960	9,46	4	41.100	67	126	2
26214666__P	HC 100 T6 5,5kW (A6:6)	960	12,8	5,5	48.700	64	130	2
26215666__P	HC 100 T6 7,5kW (A6:6)	965	15,2	7,5	50.700	65	156	2
26220663__P	HC 112 T6 2,2kW (A6:3)	940	5,94	2,2	41.000	64	119	2
26220666__P	HC 112 T6 2,2kW (A6:6)	940	5,94	2,2	32.500	69	120	2
26221663__P	HC 112 T6 3kW (A6:3)	960	7,3	3	49.400	64	135	2
26221666__P	HC 112 T6 3kW (A6:6)	960	7,3	3	39.800	68	138	2
26222663__P	HC 112 T6 4kW (A6:3)	960	9,46	4	54.200	64	141	2
26222666__P	HC 112 T6 4kW (A6:6)	960	9,46	4	47.100	68	148	2
26223663__P	HC 112 T6 5,5kW (A6:3)	960	12,8	5,5	58.200	65	144	2
26223666__P	HC 112 T6 5,5kW (A6:6)	960	12,8	5,5	53.900	67	151	2
26224666__P	HC 112 T6 7,5kW (A6:6)	965	15,2	7,5	64.100	67	203	2
26225666__P	HC 112 T6 11kW (A6:6)	970	22,6	11	67.300	68	218	2
27202674__P	HC 125 T6 3kW (A7:4)	960	7,3	3	46.300	73	155	2
27203674__P	HC 125 T6 4kW (A7:4)	960	9,46	4	55.600	71	165	2
27204674__P	HC 125 T6 5,5kW (A7:4)	960	12,8	5,5	64.300	68	170	2
27204678__P	HC 125 T6 5,5kW (A7:8)	960	12,8	5,5	47.800	79	174	2
27205674__P	HC 125 T6 7,5kW (A7:4)	965	15,2	7,5	75.700	65	223	2
27205678__P	HC 125 T6 7,5kW (A7:8)	965	15,2	7,5	58.600	77	232	2
27206674__P	HC 125 T6 11kW (A7:4)	970	22,6	11	82.400	66	240	2
27206678__P	HC 125 T6 11kW (A7:8)	970	22,6	11	78.900	74	249	2
27207678__P	HC 125 T6 15kW (A7:8)	970	27,7	15	93.300	69	289	2

2 SPEED MOTOR / 4/6 poles

Code	Model	R.P.M.	Rated I. (A) 400V	Rated power kW	Max. Airflow m3/h	Sound db (A)*	Weight Kg	Connect. diagram
26247606__PV6	HC 45 T4/T6 0,55/0,18kW (A0:6)	1410/910	1,71/0,5	0,55	7.260	50	17	3
26250606__PV6	HC 50 T4/T6 0,55/0,18kW (A0:6)	1410/910	1,71/0,5	0,55	9.320	52	24	3
26257656__PV6	HC 56 T4/T6 0,37/0,13kW (A5:6)	1380/880	1,15/0,7	0,37	7.230	58	46	3
26258626__PV6	HC 56 T4/T6 0,55/0,18kW (A2:6)	1410/910	1,71/0,5	0,55	8.290	56	48	3
26258629__PV6	HC 56 T4/T6 0,55/0,18kW (A2:9)	1410/910	1,71/0,5	0,55	6.590	56	51	3
26258656__PV6	HC 56 T4/T6 0,55/0,18kW (A5:6)	1410/910	1,71/0,5	0,55	8.680	58	48	3
26259626__PV6	HC 56 T4/T6 0,75/0,25kW (A2:6)	1420/920	1,8/0,8	0,75	10.500	55	49	3
26259629__PV6	HC 56 T4/T6 0,75/0,25kW (A2:9)	1420/920	1,8/0,8	0,75	8.170	56	50	3

Code	Model	R.P.M.	Rated I. (A) 400V	Rated power kW	Max. Airflow m3/h	Sound db (A)*	Weight Kg	Connect. diagram
26259656__PV6	HC 56 T4/T6 0,75/0,25kW (A5:6)	1420/920	1,8/0,8	0,75	10.810	59	49	3
26260626__PV6	HC 56 T4/T6 1,1/0,37kW (A2:6)	1430/930	2,8/1,2	1,1	12.900	55	50	3
26260629__PV6	HC 56 T4/T6 1,1/0,37kW (A2:9)	1430/930	2,8/1,2	1,1	11.700	57	53	3
26260656__PV6	HC 56 T4/T6 1,1/0,37kW (A5:6)	1430/930	2,8/1,2	1,1	12.520	56	50	3
26261626__PV6	HC 56 T4/T6 1,5/0,5kW (A2:6)	1430/930	4/2,2	1,5	13.900	56	53	3
26261629__PV6	HC 56 T4/T6 1,5/0,5kW (A2:9)	1430/930	4/2,2	1,5	13.600	57	55	3
26261656__PV6	HC 56 T4/T6 1,5/0,5kW (A5:6)	1430/930	4/2,2	1,5	13.560	57	52	3
26264626__PV6	HC 63 T4/T6 0,55/0,18kW (A2:6)	1410/910	1,71/0,5	0,55	9.020	54	50	3
26265626__PV6	HC 63 T4/T6 0,75/0,25kW (A2:6)	1420/920	1,8/0,8	0,75	11.400	57	51	3
26265629__PV6	HC 63 T4/T6 0,75/0,25kW (A2:9)	1420/920	1,8/0,8	0,75	9.120	59	55	3
26265656__PV6	HC 63 T4/T6 0,75/0,25kW (A5:6)	1420/920	1,8/0,8	0,75	12.020	60	51	3
26266626__PV6	HC 63 T4/T6 1,1/0,37kW (A2:6)	1430/930	2,8/1,2	1,1	15.000	57	55	3
26266629__PV6	HC 63 T4/T6 1,1/0,37kW (A2:9)	1430/930	2,8/1,2	1,1	11.700	59	59	3
26266656__PV6	HC 63 T4/T6 1,1/0,37kW (A5:6)	1430/930	2,8/1,2	1,1	14.740	61	55	3
26267626__PV6	HC 63 T4/T6 1,5/0,5kW (A2:6)	1430/930	4/2,2	1,5	18.300	57	57	3
26267629__PV6	HC 63 T4/T6 1,5/0,5kW (A2:9)	1430/930	4/2,2	1,5	15.700	60	61	3
26267656__PV6	HC 63 T4/T6 1,5/0,5kW (A5:6)	1430/930	4/2,2	1,5	16.610	59	57	3
26268626__PV6	HC 63 T4/T6 2,2/0,6kW (A2:6)	1430/940	5/1,8	2,2	20.100	58	58	3
26268629__PV6	HC 63 T4/T6 2,2/0,6kW (A2:9)	1430/940	5/1,8	2,2	20.300	60	62	3
26268656__PV6	HC 63 T4/T6 2,2/0,6kW (A5:6)	1430/940	5/1,8	2,2	18.630	59	58	3
26269629__PV6	HC 63 T4/T6 3/0,9kW (A2:9)	1440/950	7/3	3	21.800	60	63	3
26272626__PV6	HC 71 T4/T6 0,75/0,25kW (A2:6)	1420/920	1,8/0,8	0,75	12.000	63	57	3
26272656__PV6	HC 71 T4/T6 0,75/0,25kW (A5:6)	1420/920	1,8/0,8	0,75	13.630	65	58	3
26273626__PV6	HC 71 T4/T6 1,1/0,37kW (A2:6)	1430/930	2,8/1,2	1,1	15.500	62	60	3
26273629__PV6	HC 71 T4/T6 1,1/0,37kW (A2:9)	1430/930	1,25	1,1	12.100	65	62	3
26273656__PV6	HC 71 T4/T6 1,1/0,37kW (A5:6)	1430/930	1,25	1,1	16.800	64	60	3
26274626__PV6	HC 71 T4/T6 1,5/0,5kW (A2:6)	1430/930	4/2,2	1,5	20.800	61	62	3
26274629__PV6	HC 71 T4/T6 1,5/0,5kW (A2:9)	1430/930	4/2,2	1,5	15.700	64	64	3
26274656__PV6	HC 71 T4/T6 1,5/0,5kW (A5:6)	1430/930	4/2,2	1,5	19.960	63	62	3
26275626__PV6	HC 71 T4/T6 2,2/0,6kW (A2:6)	1430/940	5/1,8	2,2	25.300	60	67	3
26275629__PV6	HC 71 T4/T6 2,2/0,6kW (A2:9)	1430/940	5/1,8	2,2	21.600	63	68	3
26275656__PV6	HC 71 T4/T6 2,2/0,6kW (A5:6)	1430/940	5/1,8	2,2	23.200	62	67	3
26276626__PV6	HC 71 T4/T6 3/0,9kW (A2:6)	1440/950	7/3	3	27.900	60	69	3
26276629__PV6	HC 71 T4/T6 3/0,9kW (A2:9)	1440/950	7/3	3	25.300	63	71	3
26276656__PV6	HC 71 T4/T6 3/0,9kW (A5:6)	1440/950	7/3	3	25.160	65	69	3
26281626__PV6	HC 80 T4/T6 1,1/0,37kW (A2:6)	1430/930	1,25	1,1	15.400	63	58	3
26282626__PV6	HC 80 T4/T6 1,5/0,5kW (A2:6)	1430/930	4/2,2	1,5	20.300	63	62	3
26282629__PV6	HC 80 T4/T6 1,5/0,5kW (A2:9)	1430/930	4/2,2	1,5	16.200	71	63	3
26283626__PV6	HC 80 T4/T6 2,2/0,6kW (A2:6)	1430/940	5/1,8	2,2	27.900	63	71	3

Code	Model	R.P.M.	Rated I. (A) 400V	Rated power kW	Max. Airflow m3/h	Sound db (A)*	Weight Kg	Connect. diagram
26283629__PV6	HC 80 T4/T6 2,2/0,6kW (A2:9)	1430/940	5/1,8	2,2	21.200	69	74	3
26284626__PV6	HC 80 T4/T6 3/0,9kW (A2:6)	1440/950	7/3	3	32.500	63	75	3
26284629__PV6	HC 80 T4/T6 3/0,9kW (A2:9)	1440/950	7/3	3	26.400	68	78	3
26284656__PV6	HC 80 T4/T6 3/0,9kW (A5:6)	1440/950	7/3	3	31.090	68	75	3
26285626__PV6	HC 80 T4/T6 4/1,1kW (A2:6)	1430/940	9/3,3	4	36.100	62	86	3
26285629__PV6	HC 80 T4/T6 4/1,1kW (A2:9)	1430/940	9/3,3	4	31.900	67	88	3
26285656__PV6	HC 80 T4/T6 4/1,1kW (A5:6)	1430/940	9/3,3	4	34.000	65	86	3
26286626__PV6	HC 80 T4/T6 5,5/1,85kW (A2:6)	1450/950	12/4,7	5,5	39.000	62	88	3
26286629__PV6	HC 80 T4/T6 5,5/1,85kW (A2:9)	1450/950	12/4,7	5,5	38.200	65	91	3
26293663__PV6	HC 90 T4/T6 3/0,9kW (A6:3)	1440/950	7/3	3	30.700	63	86	3
26294663__PV6	HC 90 T4/T6 4/1,1kW (A6:3)	1430/940	9/3,3	4	37.700	66	97	3
26295663__PV6	HC 90 T4/T6 5,5/1,85kW (A6:3)	1450/950	12/4,7	5,5	41.400	68	101	3
26295666__PV6	HC 90 T4/T6 5,5/1,85kW (A6:6)	1450/950	12/4,7	5,5	33.400	71	105	3
26296663__PV6	HC 90 T4/T6 7,5/2,2kW (A6:3)	1450/950	15,5/6	7,5	45.700	69	113	3
26296666__PV6	HC 90 T4/T6 7,5/2,2kW (A6:6)	1450/950	15,5/6	7,5	40.800	72	118	3
26297663__PV6	HC 90 T4/T6 11/3,6kW (A6:3)	1430/940	23/10	11	49.700	71	154	3
26297666__PV6	HC 90 T4/T6 11/3,6kW (A6:6)	1430/940	23/10	11	48.700	73	158	3
26298666__PV6	HC 90 T4/T6 15/4,4kW (A6:6)	1420/940	28/11	15	56.500	70	178	3
26214663__PV6	HC 100 T4/T6 5,5/1,85kW (A6:3)	1450/950	12/4,7	5,5	48.700	69	114	3
26215663__PV6	HC 100 T4/T6 7,5/2,2kW (A6:3)	1450/950	15,5/6	7,5	55.500	68	128	3
26215666__PV6	HC 100 T4/T6 7,5/2,2kW (A6:6)	1450/950	15,5/6	7,5	44.200	76	131	3
26216663__PV6	HC 100 T4/T6 11/3,6kW (A6:3)	1430/940	23/10	11	63.000	70	168	3
26216666__PV6	HC 100 T4/T6 11/3,6kW (A6:6)	1430/940	23/10	11	56.200	77	173	3
26217663__PV6	HC 100 T4/T6 15/4,4kW (A6:3)	1420/940	28/11	15	67.100	72	194	3
26217666__PV6	HC 100 T4/T6 15/4,4kW (A6:6)	1420/940	28/11	15	63.500	76	197	3
26218666__PV6	HC 100 T4/T6 18,5/6kW (A6:6)	1420/930	36/14	18,5	71.200	73	237	3
26219666__PV6	HC 100 T4/T6 22/7,5kW (A6:6)	1420/940	42/16	22	78.300	75	246	3
26223663__PV6	HC 112 T4/T6 5,5/1,85kW (A6:3)	1450/950	12/4,7	5,5	52.700	73	135	3
26224663__PV6	HC 112 T4/T6 7,5/2,2kW (A6:3)	1450/950	15,5/6	7,5	63.400	74	145	3
26225663__PV6	HC 112 T4/T6 11/3,6kW (A6:3)	1430/940	23/10	11	72.600	74	182	3
26225666__PV6	HC 112 T4/T6 11/3,6kW (A6:6)	1430/940	23/10	11	55.700	78	188	3
26226663__PV6	HC 112 T4/T6 15/4,4kW (A6:3)	1420/940	28/11	15	83.600	73	203	3
26226666__PV6	HC 112 T4/T6 15/4,4kW (A6:6)	1420/940	28/11	15	72.700	78	208	3
26227663__PV6	HC 112 T4/T6 18,5/6kW (A6:3)	1420/930	36/14	18,5	87.300	74	240	3
26227666__PV6	HC 112 T4/T6 18,5/6kW (A6:6)	1420/930	36/14	18,5	77.900	77	245	3
26228663__PV6	HC 112 T4/T6 22/7,5kW (A6:3)	1420/940	42/16	22	89.800	74	241	3
26228666__PV6	HC 112 T4/T6 22/7,5kW (A6:6)	1420/940	42/16	22	88.400	76	246	3
27206674__PV6	HC 125 T4/T6 11/3,6kW (A7:4)	1430/940	23/10	11	71.400	83	207	3
27207674__PV6	HC 125 T4/T6 15/4,4kW (A7:4)	1420/940	28/11	15	85.800	81	230	3

Code	Model	R.P.M.	Rated I. (A) 400V	Rated power kW	Max. Airflow m3/h	Sound db (A)*	Weight Kg	Connect. diagram
27207678__PV6	HC 125 T4/T6 15/4,4kW (A7:8)	1420/940	28/11	15	66.300	89	235	3
27208674__PV6	HC 125 T4/T6 18,5/6kW (A7:4)	1420/930	36/14	18,5	99.200	78	275	3
27208678__PV6	HC 125 T4/T6 18,5/6kW (A7:8)	1420/930	36/14	18,5	73.800	87	278	3
27209674__PV6	HC 125 T4/T6 22/7,5kW (A7:4)	1420/940	42/16	22	105.000	75	272	3
27209678__PV6	HC 125 T4/T6 22/7,5kW (A7:8)	1420/940	42/16	22	81.800	86	279	3

2 SPEED MOTOR / 4/8 poles

Code	Model	R.P.M.	Rated I. (A) 400V	Rated power kW	Max. Airflow m3/h	Sound db (A)*	Weight Kg	Connect. diagram
26245606__PV	HC 45 T4/T8 0,33/0,04kW (A0:6)	1360/650	1,5/0,5	0,33/0,04	6.605	53	17	4
26250606__PV	HC 50 T4/T8 0,55/0,09kW (A0:6)	1410/710	2/0,5	0,55/0,09	9.320	52	24	4
26257656__PV	HC 56 T4/T8 0,33/0,04kW (A5:6)	1360/650	1,5/0,5	0,33/0,04	7.230	58	47	4
26258626__PV	HC 56 T4/T8 0,55/0,09kW (A2:6)	1410/710	2/0,5	0,55/0,09	8.290	56	47	4
26258629__PV	HC 56 T4/T8 0,55/0,09kW (A2:9)	1410/710	2/0,5	0,55/0,09	6.590	56	47	4
26258656__PV	HC 56 T4/T8 0,55/0,09kW (A5:6)	1410/710	2/0,5	0,55/0,09	8.680	58	48	4
26259626__PV	HC 56 T4/T8 0,75/0,12kW (A2:6)	1430/710	1,8/1	0,75/0,12	10.500	55	53	4
26259629__PV	HC 56 T4/T8 0,75/0,12kW (A2:9)	1430/710	1,8/1	0,75/0,12	8.170	56	53	4
26259656__PV	HC 56 T4/T8 0,75/0,12kW (A5:6)	1430/710	1,8/1	0,75/0,12	10.810	59	49	4
26260626__PV	HC 56 T4/T8 1,1/0,18kW (A2:6)	1400/710	3/0,8	1,1/0,18	12.900	55	50	4
26260629__PV	HC 56 T4/T8 1,1/0,18kW (A2:9)	1400/710	3/0,8	1,1/0,18	11.700	57	53	4
26260656__PV	HC 56 T4/T8 1,1/0,18kW (A5:6)	1400/710	3/0,8	1,1/0,18	12.520	56	50	4
26261626__PV	HC 56 T4/T8 1,5/0,25kW (A2:6)	1380/700	4/1,5	1,5/0,25	13.900	56	53	4
26261629__PV	HC 56 T4/T8 1,5/0,25kW (A2:9)	1380/700	4/1,5	1,5/0,25	13.600	57	55	4
26261656__PV	HC 56 T4/T8 1,5/0,25kW (A5:6)	1380/700	4/1,5	1,5/0,25	13.560	57	52	4
26264626__PV	HC 63 T4/T8 0,55/0,09kW (A2:6)	1410/710	2/0,5	0,55/0,09	9.020	54	53	4
26265626__PV	HC 63 T4/T8 0,75/0,12kW (A2:6)	1430/710	1,8/1	0,75/0,12	11.400	57	54	4
26265629__PV	HC 63 T4/T8 0,75/0,12kW (A2:9)	1430/710	1,8/1	0,75/0,12	9.120	59	55	4
26265656__PV	HC 63 T4/T8 0,75/0,12kW (A5:6)	1430/710	1,8/1	0,75/0,12	12.020	60	51	4
26266626__PV	HC 63 T4/T8 1,1/0,18kW (A2:6)	1400/710	3/0,8	1,1/0,18	15.000	57	54	4
26266629__PV	HC 63 T4/T8 1,1/0,18kW (A2:9)	1400/710	3/0,8	1,1/0,18	13.500	59	56	4
26266656__PV	HC 63 T4/T8 1,1/0,18kW (A5:6)	1400/710	3/0,8	1,1/0,18	14.740	61	55	4
26267626__PV	HC 63 T4/T8 1,5/0,25kW (A2:6)	1380/700	4/1,5	1,5/0,25	18.300	57	52	4
26267629__PV	HC 63 T4/T8 1,5/0,25kW (A2:9)	1380/700	4/1,5	1,5/0,25	15.700	60	55	4
26267656__PV	HC 63 T4/T8 1,5/0,25kW (A5:6)	1380/700	4/1,5	1,5/0,25	16.610	59	57	4
26268626__PV	HC 63 T4/T8 2,2/0,37kW (A2:6)	1430/720	4/1,25	2,2/0,37	20.100	58	53	4
26268629__PV	HC 63 T4/T8 2,2/0,37kW (A2:9)	1430/720	4/1,25	2,2/0,37	20.300	60	56	4
26268656__PV	HC 63 T4/T8 2,2/0,37kW (A5:6)	1430/720	4/1,25	2,2/0,37	18.630	59	58	4

Code	Model	R.P.M.	Rated I. (A) 400V	Rated power kW	Max. Airflow m3/h	Sound db (A)*	Weight Kg	Connect. diagram
26269629__PV	HC 63 T4/T8 3/0,55kW (A2:9)	1420/710	6,6/18	3/0,55	21.800	60	63	4
26272626__PV	HC 71 T4/T8 0,75/0,12kW (A2:6)	1430/710	1,8/1	0,75/0,12	12.000	63	57	4
26272656__PV	HC 71 T4/T8 0,75/0,12kW (A5:6)	1430/710	1,8/1	0,75/0,12	13.630	65	58	4
26273626__PV	HC 71 T4/T8 1,1/0,18kW (A2:6)	1400/710	3/0,8	1,1/0,18	15.500	62	58	4
26273629__PV	HC 71 T4/T8 1,1/0,18kW (A2:9)	1400/710	3/0,8	1,1/0,18	12.100	65	61	4
26273656__PV	HC 71 T4/T8 1,1/0,18kW (A5:6)	1400/710	3/0,8	1,1/0,18	16.800	64	60	4
26274626__PV	HC 71 T4/T8 1,5/0,25kW (A2:6)	1380/700	4/1,5	1,5/0,25	20.800	61	61	4
26274629__PV	HC 71 T4/T8 1,5/0,25kW (A2:9)	1380/700	4/1,5	1,5/0,25	15.700	64	61	4
26274656__PV	HC 71 T4/T8 1,5/0,25kW (A5:6)	1380/700	4/1,5	1,5/0,25	19.960	63	62	4
26275626__PV	HC 71 T4/T8 2,2/0,37kW (A2:6)	1430/720	4/1,25	2,2/0,37	25.300	60	64	4
26275629__PV	HC 71 T4/T8 2,2/0,37kW (A2:9)	1430/720	4/1,25	2,2/0,37	21.600	63	65	4
26275656__PV	HC 71 T4/T8 2,2/0,37kW (A5:6)	1430/720	4/1,25	2,2/0,37	23.200	62	67	4
26276626__PV	HC 71 T4/T8 3/0,55kW (A2:6)	1420/710	6,6/18	3/0,55	27.900	60	66	4
26276629__PV	HC 71 T4/T8 3/0,55kW (A2:9)	1420/710	6,6/18	3/0,55	25.300	63	67	4
26276656__PV	HC 71 T4/T8 3/0,55kW (A5:6)	1420/710	6,6/18	3/0,55	25.160	65	69	4
26281626__PV	HC 80 T4/T8 1,1/0,18kW (A2:6)	1400/710	3/0,8	1,1/0,18	15.400	63	63	4
26282626__PV	HC 80 T4/T8 1,5/0,25kW (A2:6)	1380/700	4/1,5	1,5/0,25	20.300	63	64	4
26282629__PV	HC 80 T4/T8 1,5/0,25kW (A2:9)	1380/700	4/1,5	1,5/0,25	16.200	71	64	4
26283626__PV	HC 80 T4/T8 2,2/0,37kW (A2:6)	1430/720	4/1,25	2,2/0,37	27.900	63	65	4
26283629__PV	HC 80 T4/T8 2,2/0,37kW (A2:9)	1430/720	4/1,25	2,2/0,37	21.200	69	66	4
26284626__PV	HC 80 T4/T8 3/0,55kW (A2:6)	1420/710	6,6/18	3/0,55	32.500	63	70	4
26284629__PV	HC 80 T4/T8 3/0,55kW (A2:9)	1420/710	6,6/18	3/0,55	26.400	68	71	4
26284656__PV	HC 80 T4/T8 3/0,55kW (A5:6)	1420/710	6,6/18	3/0,55	31.090	68	75	4
26285626__PV	HC 80 T4/T8 4/0,75kW (A2:6)	1440/720	8,5/21,8	4/0,75	36.100	62	86	4
26285629__PV	HC 80 T4/T8 4/0,75kW (A2:9)	1440/720	8,5/21,8	4/0,75	29.100	67	86	4
26285656__PV	HC 80 T4/T8 4/0,75kW (A5:6)	1440/720	8,5/21,8	4/0,75	34.000	65	86	4
26286626__PV	HC 80 T4/T8 5,5/1,1kW (A2:6)	1450/720	11/27,2	5,5/1,1	39.000	62	88	4
26286629__PV	HC 80 T4/T8 5,5/1,1kW (A2:9)	1450/720	11/27,2	5,5/1,1	36.700	66	88	4
26293663__PV	HC 90 T4/T8 3/0,55kW (A6:3)	1420/710	6,6/18	3/0,55	30.700	63	82	4
26294663__PV	HC 90 T4/T8 4/0,75kW (A6:3)	1440/720	8,5/21,8	4/0,75	37.700	66	87	4
26295663__PV	HC 90 T4/T8 5,5/1,1kW (A6:3)	1450/720	11/27,2	5,5/1,1	41.400	68	96	4
26295666__PV	HC 90 T4/T8 5,5/1,1kW (A6:6)	1450/720	11/27,2	5,5/1,1	33.400	71	97	4
26296663__PV	HC 90 T4/T8 7,5/1,5kW (A6:3)	1450/720	15/4	7,5/1,5	45.700	69	113	4
26296666__PV	HC 90 T4/T8 7,5/1,5kW (A6:6)	1450/720	15/4	7,5/1,5	40.800	72	118	4
26297663__PV	HC 90 T4/T8 11/3kW (A6:3)	1460/720	22/8,5	11/3	49.700	71	158	4
26297666__PV	HC 90 T4/T8 11/3kW (A6:6)	1460/720	22/8,5	11/3	48.700	73	161	4
26297666__PV	HC 90 T4/T8 15/3,5kW (A6:6)	1460/720	29,5/11,5	15/3,5	56.500	70	168	4
26214663__PV	HC 100 T4/T8 5,5/1,1kW (A6:3)	1450/720	11/27,2	5,5/1,1	48.700	69	114	4
26215663__PV	HC 100 T4/T8 7,5/1,5kW (A6:3)	1450/720	15/4	7,5/1,5	55.500	68	128	4

Code	Model	R.P.M.	Rated I. (A) 400V	Rated power kW	Max. Airflow m3/h	Sound db (A)*	Weight Kg	Connect. diagram
26215666__PV	HC 100 T4/T8 7,5/1,5kW (A6:6)	1450/720	15/4	7,5/1,5	44.200	76	131	4
26216663__PV	HC 100 T4/T8 11/3kW (A6:3)	1460/720	22/8,5	11/3	63.000	70	173	4
26216666__PV	HC 100 T4/T8 11/3kW (A6:6)	1460/720	22/8,5	11/3	56.200	77	176	4
26216663__PV	HC 100 T4/T8 15/3,5kW (A6:3)	1460/720	29,5/11,5	15/3,5	67.100	72	168	4
26216666__PV	HC 100 T4/T8 15/3,5kW (A6:6)	1460/720	29,5/11,5	15/3,5	63.500	76	173	4
26218666__PV	HC 100 T4/T8 17/4,3kW (A6:6)	1475/730	33,4/12,7	17/4,3	71.200	73	197	4
26219666__PV	HC 100 T4/T8 20/5kW (A6:6)	1470/730	38,6/14,1	20/5	75.200	73	237	4
26223663__PV	HC 112 T4/T8 5,5/1,1kW (A6:3)	1450/720	11/27,2	5,5/1,1	52.700	73	135	4
26224663__PV	HC 112 T4/T8 7,5/1,5kW (A6:3)	1450/720	15/4	7,5/1,5	63.400	74	145	4
26225663__PV	HC 112 T4/T8 11/3kW (A6:3)	1460/720	22/8,5	11/3	72.600	74	169	4
26225666__PV	HC 112 T4/T8 11/3kW (A6:6)	1460/720	22/8,5	11/3	55.700	78	174	4
26226663__PV	HC 112 T4/T8 15/3,5kW (A6:3)	1460/720	29,5/11,5	15/3,5	83.600	73	183	4
26226666__PV	HC 112 T4/T8 15/3,5kW (A6:6)	1460/720	29,5/11,5	15/3,5	72.700	78	188	4
26227663__PV	HC 112 T4/T8 17/4,3kW (A6:3)	1475/730	33,4/12,7	17/4,3	87.300	74	203	4
26227666__PV	HC 112 T4/T8 17/4,3kW (A6:6)	1475/730	33,4/12,7	17/4,3	77.900	77	208	4
26228663__PV	HC 112 T4/T8 20/5kW (A6:3)	1470/730	38,6/14,1	20/5	89.800	74	240	4
26228666__PV	HC 112 T4/T8 20/5kW (A6:6)	1470/730	38,6/14,1	20/5	83.100	76	245	4
26229666__PV	HC 112 T4/T8 28/6,5kW (A6:6)	1480/735	52/18	28/6,5	98.900	77	246	4
26230666__PV	HC 112 T4/T8 35/8kW (A6:6)	1470/730	67,3/21,8	35/8	104.000	78	370	4
27206674__PV	HC 125 T4/T8 11/3kW (A7:4)	1460/720	22/8,5	11/3	71.400	83	212	4
27206674__PV	HC 125 T4/T8 15/3,5kW (A7:4)	1460/720	29,5/11,5	15/3,5	85.800	81	230	4
27206678__PV	HC 125 T4/T8 15/3,5kW (A7:8)	1460/720	29,5/11,5	15/3,5	66.300	89	235	4
27208674__PV	HC 125 T4/T8 17/4,3kW (A7:4)	1475/730	33,4/12,7	17/4,3	93.200	78	230	4
27209674__PV	HC 125 T4/T8 20/5kW (A7:4)	1470/730	38,6/14,1	20/5	99.200	76	271	4
27209678__PV	HC 125 T4/T8 20/5kW (A7:8)	1470/730	38,6/14,1	20/5	73.800	87	278	4
27210674__PV	HC 125 T4/T8 28/6,5kW (A7:4)	1480/735	52/18	28/6,5	117.000	75	272	4
27210678__PV	HC 125 T4/T8 28/6,5kW (A7:8)	1480/735	52/18	28/6,5	90.500	86	279	4
27211674__PV	HC 125 T4/T8 35/8kW (A7:4)	1470/730	67,3/21,8	35/8	127.000	76	408	4
27211678__PV	HC 125 T4/T8 35/8kW (A7:8)	1470/730	67,3/21,8	35/8	107.000	84	413	4
27211678__PV	HC 125 T4/T8 37/9,2kW (A7:8)	1485/740	74,2/25,4	37/9,2	114.000	80	416	4
27212678__PV	HC 125 T4/T8 44/11kW (A7:8)	1480/740	80,2/27,2	44/11	122.000	79	455	4

Notes:
 * Total sound pressure level at the point of maximum flow measured in dB(A) in the suction measured in free field at a distance of 6m from the source

DIMENSIONS DIAGRAM

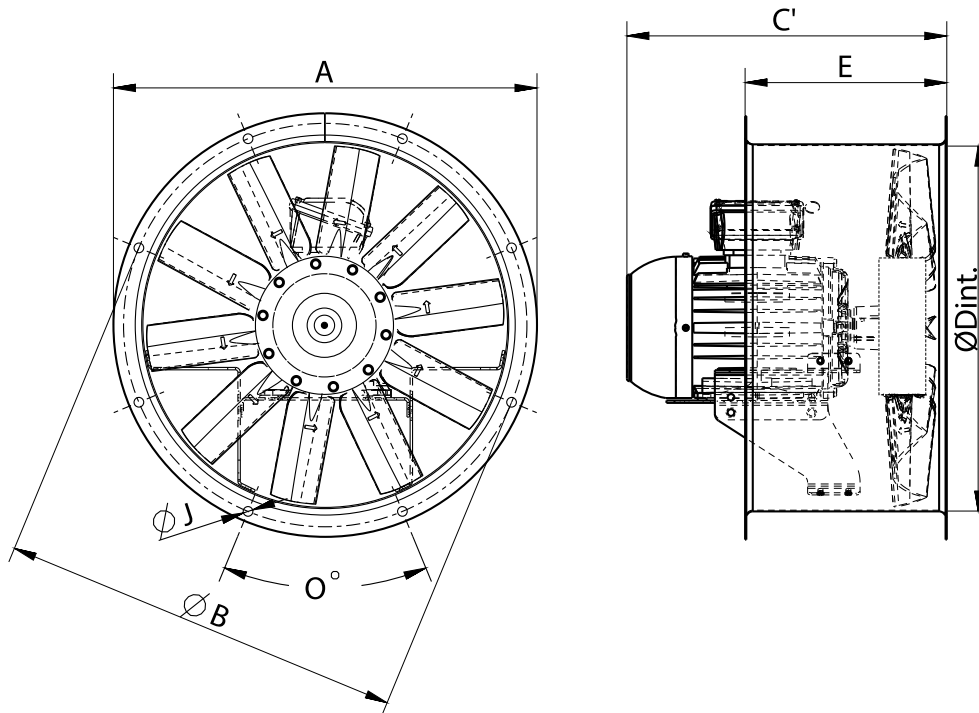

Model	ØA	ØB	C'	ØDint	E	ØJ	O
HC 35 M2 0,55kW (A0:6)	434	395	311	365	250	10	8x45°
HC 35 M2 1,1kW (A0:6)	434	395	340	365	250	10	8x45°
HC 35 M4 0,12kW (A0:6)	434	395	308	365	250	10	8x45°
HC 35 T2 0,55kW (A0:6)	434	395	311	365	250	10	8x45°
HC 35 T2 1,1kW (A0:6)	434	395	340	365	250	10	8x45°
HC 35 T4 0,12kW (A0:6)	434	395	308	365	250	10	8x45°
HC 40 M4 0,25kW (A0:6)	472	450	311	403	250	10	8x45°
HC 40 M6 0,04kW (A0:6)	472	450	308	403	250	10	8x45°
HC 40 T2 1,1kW (A0:6)	472	450	345	403	250	10	8x45°
HC 40 T4 0,25kW (A0:6)	472	450	311	403	250	10	8x45°
HC 40 T6 0,12kW (A0:6)	472	450	308	403	250	10	8x45°
HC 45 M4 0,37kW (A0:6)	525	500	348	452	250	12	8x45°
HC 45 M6 0,13kW (A0:6)	525	500	357	452	250	12	8x45°
HC 45 T2 1,5kW (A0:6)	525	500	397	452	250	12	8x45°
HC 45 T2 2,2kW (A0:6)	525	500	397	452	250	12	8x45°
HC 45 T4 0,55kW (A0:6)	525	500	357	452	250	12	8x45°
HC 45 T6 0,13kW (A0:6)	525	500	357	452	250	12	8x45°
HC 45 T4/T6 0,55/0,18kW (A0:6)	525	500	357	452	250	12	8x45°
HC 45 T4/T8 0,33/0,04kW (A0:6)	525	500	348	452	250	12	8x45°
HC 50 M4 0,55kW (A0:6)	600	560	362	504	250	12	12x30°

Model	ØA	ØB	C'	ØDint	E	ØJ	O
HC 50 M6 0,13kW (A0:6)	600	560	362	504	250	12	12x30°
HC 50 T4 0,55kW (A0:6)	600	560	362	504	250	12	12x30°
HC 50 T6 0,13kW (A0:6)	600	560	362	504	250	12	12x30°
HC 50 T4/T6 0,55/0,18kW (A0:6)	600	560	362	504	250	12	12x30°
HC 50 T4/T8 0,55/0,09kW (A0:6)	600	560	362	504	250	12	12x30°
HC 56 M4 0,37kW (A5:6)	646	620	348	559	250	12	12x30°
HC 56 M4 0,55kW (A2:6)	646	620	362	559	250	12	12x30°
HC 56 M4 0,55kW (A5:6)	646	620	362	559	250	12	12x30°
HC 56 M6 0,25kW (A2:6)	646	620	348	559	250	12	12x30°
HC 56 M6 0,25kW (A5:6)	646	620	348	559	250	12	12x30°
HC 56 M6 0,37kW (A2:6)	646	620	362	559	250	12	12x30°
HC 56 M6 0,37kW (A5:6)	646	620	362	559	250	12	12x30°
HC 56 T4 0,37kW (A5:6)	646	620	348	559	250	12	12x30°
HC 56 T4 0,55kW (A2:6)	646	620	362	559	250	12	12x30°
HC 56 T4 0,55kW (A2:9)	646	620	362	559	250	12	12x30°
HC 56 T4 0,55kW (A5:6)	646	620	362	559	250	12	12x30°
HC 56 T4 0,75kW (A2:6)	646	620	362	559	250	12	12x30°
HC 56 T4 0,75kW (A2:9)	646	620	362	559	250	12	12x30°
HC 56 T4 0,75kW (A5:6)	646	620	362	559	250	12	12x30°
HC 56 T4 1,1kW (A2:6)	646	620	372	559	250	12	12x30°
HC 56 T4 1,1kW (A2:9)	646	620	372	559	250	12	12x30°
HC 56 T4 1,1kW (A5:6)	646	620	372	559	250	12	12x30°
HC 56 T4 1,5kW (A2:6)	646	620	397	559	250	12	12X30°
HC 56 T4 1,5kW (A2:9)	646	620	397	559	250	12	12x30°
HC 56 T4 1,5kW (A5:6)	646	620	397	559	250	12	12x30°
HC 56 T6 0,25kW (A5:6)	646	620	348	559	250	12	12x30°
HC 56 T6 0,37kW (A5:6)	646	620	362	559	250	12	12x30°
HC 56 T6 0,55kW (A2:6)	646	620	362	559	250	12	12x30°
HC 56 T6 0,55kW (A2:9)	646	620	362	559	250	12	12X30°
HC 56 T4/T6 0,37/0,13kW (A5:6)	646	620	348	559	250	12	12x30°
HC 56 T4/T6 0,55/0,18kW (A2:6)	646	620	362	559	250	12	12x30°
HC 56 T4/T6 0,55/0,18kW (A2:9)	646	620	362	559	250	12	12x30°
HC 56 T4/T6 0,55/0,18kW (A5:6)	646	620	362	559	250	12	12x30°
HC 56 T4/T6 0,75/0,25kW (A2:6)	646	620	362	559	250	12	12x30°
HC 56 T4/T6 0,75/0,25kW (A2:9)	646	620	362	559	250	12	12x30°
HC 56 T4/T6 0,75/0,25kW (A5:6)	646	620	362	559	250	12	12x30°
HC 56 T4/T6 1,1/0,37kW (A2:6)	646	620	372	559	250	12	12x30°
HC 56 T4/T6 1,1/0,37kW (A2:9)	646	620	372	559	250	12	12x30°
HC 56 T4/T6 1,1/0,37kW (A5:6)	646	620	372	559	250	12	12x30°
HC 56 T4/T6 1,5/0,5kW (A2:6)	646	620	397	559	250	12	12X30°

Model	ØA	ØB	C'	ØDint	E	ØJ	O
HC 56 T4/T6 1,5/0,5kW (A2:9)	646	620	397	559	250	12	12x30°
HC 56 T4/T6 1,5/0,5kW (A5:6)	646	620	397	559	250	12	12x30°
HC 56 T4/T8 0,33/0,04kW (A5:6)	646	620	348	559	250	12	12x30°
HC 56 T4/T8 0,55/0,09kW (A2:6)	646	620	362	559	250	12	12X30°
HC 56 T4/T8 0,55/0,09kW (A2:9)	646	620	362	559	250	12	12X30°
HC 56 T4/T8 0,55/0,09kW (A5:6)	646	620	362	559	250	12	12x30°
HC 56 T4/T8 0,75/0,12kW (A2:6)	646	620	362	559	250	12	12X30°
HC 56 T4/T8 0,75/0,12kW (A2:9)	646	620	362	559	250	12	12X30°
HC 56 T4/T8 0,75/0,12kW (A5:6)	646	620	362	559	250	12	12x30°
HC 56 T4/T8 1,1/0,18kW (A2:6)	646	620	372	559	250	12	12x30°
HC 56 T4/T8 1,1/0,18kW (A2:9)	646	620	372	559	250	12	12x30°
HC 56 T4/T8 1,1/0,18kW (A5:6)	646	620	372	559	250	12	12x30°
HC 56 T4/T8 1,5/0,25kW (A2:6)	646	620	397	559	250	12	12X30°
HC 56 T4/T8 1,5/0,25kW (A2:9)	646	620	397	559	250	12	12x30°
HC 56 T4/T8 1,5/0,25kW (A5:6)	646	620	397	559	250	12	12x30°
HC 63 M6 0,37kW (A5:6)	725	690	359	633	250	12	12x30°
HC 63 M6 0,55kW (A2:9)	725	690	359	633	250	12	12x30°
HC 63 M6 0,55kW (A5:6)	725	690	359	633	250	12	12x30°
HC 63 T4 0,55kW (A2:6)	725	690	359	633	250	12	12x30°
HC 63 T4 0,75kW (A2:6)	725	690	359	633	250	12	12x30°
HC 63 T4 0,75kW (A2:9)	725	690	359	633	250	12	12x30°
HC 63 T4 0,75kW (A5:6)	725	690	359	633	250	12	12x30°
HC 63 T4 1,1kW (A2:6)	725	690	393	633	250	12	12x30°
HC 63 T4 1,1kW (A2:9)	725	690	393	633	250	12	12x30°
HC 63 T4 1,1kW (A5:6)	725	690	393	633	250	12	12x30°
HC 63 T4 1,5kW (A2:6)	725	690	398	633	250	12	12x30°
HC 63 T4 1,5kW (A2:9)	725	690	398	633	250	12	12x30°
HC 63 T4 1,5kW (A5:6)	725	690	398	633	250	12	12x30°
HC 63 T4 2,2kW (A2:6)	725	690	450	633	250	12	12x30°
HC 63 T4 2,2kW (A2:9)	725	690	450	633	250	12	12x30°
HC 63 T4 2,2kW (A5:6)	725	690	450	633	250	12	12x30°
HC 63 T4 3kW (A2:9)	725	690	450	633	250	12	12x30°
HC 63 T6 0,37kW (A5:6)	725	690	359	633	250	12	12x30°
HC 63 T6 0,55kW (A2:6)	725	690	359	633	250	12	12x30°
HC 63 T6 0,55kW (A2:9)	725	690	359	633	250	12	12x30°
HC 63 T6 0,55kW (A5:6)	725	690	359	633	250	12	12x30°
HC 63 T6 0,75kW (A2:9)	725	690	393	633	250	12	12x30°
HC 63 T4/T6 0,55/0,18kW (A2:6)	725	690	359	633	250	12	12x30°
HC 63 T4/T6 0,75/0,25kW (A2:6)	725	690	359	633	250	12	12x30°
HC 63 T4/T6 0,75/0,25kW (A2:9)	725	690	359	633	250	12	12x30°

Model	ØA	ØB	C'	ØDint	E	ØJ	O
HC 63 T4/T6 0,75/0,25kW (A5:6)	725	690	359	633	250	12	12x30°
HC 63 T4/T6 1,1/0,37kW (A2:6)	725	690	393	633	250	12	12x30°
HC 63 T4/T6 1,1/0,37kW (A2:9)	725	690	393	633	250	12	12x30°
HC 63 T4/T6 1,1/0,37kW (A5:6)	725	690	393	633	250	12	12x30°
HC 63 T4/T6 1,5/0,5kW (A2:6)	725	690	398	633	250	12	12x30°
HC 63 T4/T6 1,5/0,5kW (A2:9)	725	690	398	633	250	12	12x30°
HC 63 T4/T6 1,5/0,5kW (A5:6)	725	690	398	633	250	12	12x30°
HC 63 T4/T6 2,2/0,6kW (A2:6)	725	690	450	633	250	12	12x30°
HC 63 T4/T6 2,2/0,6kW (A2:9)	725	690	450	633	250	12	12x30°
HC 63 T4/T6 2,2/0,6kW (A5:6)	725	690	450	633	250	12	12x30°
HC 63 T4/T6 3/0,9kW (A2:9)	725	690	450	633	250	12	12x30°
HC 63 T4/T8 0,55/0,09kW (A2:6)	725	690	359	633	250	12	12X30°
HC 63 T4/T8 0,75/0,12kW (A2:6)	725	690	359	633	250	12	12X30°
HC 63 T4/T8 0,75/0,12kW (A2:9)	725	690	359	633	250	12	12X30°
HC 63 T4/T8 0,75/0,12kW (A5:6)	725	690	359	633	250	12	12x30°
HC 63 T4/T8 1,1/0,18kW (A2:6)	725	690	393	633	250	12	12X30°
HC 63 T4/T8 1,1/0,18kW (A2:9)	725	690	363	633	250	12	12X30°
HC 63 T4/T8 1,1/0,18kW (A5:6)	725	690	393	633	250	12	12x30°
HC 63 T4/T8 1,5/0,25kW (A2:6)	725	690	398	633	250	12	12X30°
HC 63 T4/T8 1,5/0,25kW (A2:9)	725	690	398	633	250	12	12X30°
HC 63 T4/T8 1,5/0,25kW (A5:6)	725	690	398	633	250	12	12x30°
HC 63 T4/T8 2,2/0,37kW (A2:6)	725	690	450	633	250	12	12X30°
HC 63 T4/T8 2,2/0,37kW (A2:9)	725	690	450	633	250	12	12X30°
HC 63 T4/T8 2,2/0,37kW (A5:6)	725	690	450	633	250	12	12x30°
HC 63 T4/T8 3/0,55kW (A2:9)	725	690	450	633	250	12	12X30°
HC 71 M6 0,55kW (A2:6)	802	770	362	715	350	12	16x22,5°
HC 71 M6 0,55kW (A2:9)	802	770	362	715	350	12	16x22,5°
HC 71 T4 0,75kW (A2:6)	802	770	362	715	350	12	16x22,5°
HC 71 T4 0,75kW (A5:6)	802	770	362	715	350	12	16x22,5°
HC 71 T4 1,1kW (A2:6)	802	770	396	715	350	12	16x22,5°
HC 71 T4 1,1kW (A2:9)	802	770	421	715	350	12	16x22,5°
HC 71 T4 1,1kW (A5:6)	802	770	396	715	350	12	16x22,5°
HC 71 T4 1,5kW (A2:6)	802	770	421	715	350	12	16x22,5°
HC 71 T4 1,5kW (A2:9)	802	770	421	715	350	12	16x22,5°
HC 71 T4 1,5kW (A5:6)	802	770	421	715	350	12	16x22,5°
HC 71 T4 2,2kW (A2:6)	802	770	452	715	350	12	16x22,5°
HC 71 T4 2,2kW (A2:9)	802	770	452	715	350	12	16x22,5°
HC 71 T4 2,2kW (A5:6)	802	770	452	715	350	12	16x22,5°
HC 71 T4 3kW (A2:6)	802	770	452	715	350	12	16x22,5°
HC 71 T4 3kW (A2:9)	802	770	452	715	350	12	16x22,5°

Model	ØA	ØB	C'	ØDint	E	ØJ	O
HC 71 T4 3kW (A5:6)	802	770	452	715	350	12	16x22,5°
HC 71 T6 0,55kW (A2:6)	802	770	362	715	350	12	16x22,5°
HC 71 T6 0,55kW (A2:9)	802	770	362	715	350	12	16x22,5°
HC 71 T6 0,75kW (A2:6)	802	770	396	715	350	12	16x22,5°
HC 71 T6 0,75kW (A2:9)	802	770	396	715	350	12	16x22,5°
HC 71 T6 0,75kW (A5:6)	802	770	396	715	350	12	16x22,5°
HC 71 T6 1,1kW (A2:9)	802	770	421	715	350	12	16x22,5°
HC 71 T4/T6 0,75/0,25kW (A2:6)	802	770	362	715	350	12	16x22,5°
HC 71 T4/T6 0,75/0,25kW (A5:6)	802	770	362	715	350	12	16x22,5°
HC 71 T4/T6 1,1/0,37kW (A2:6)	802	770	396	715	350	12	16x22,5°
HC 71 T4/T6 1,1/0,37kW (A2:9)	802	770	421	715	350	12	16x22,5°
HC 71 T4/T6 1,1/0,37kW (A5:6)	802	770	396	715	350	12	16x22,5°
HC 71 T4/T6 1,5/0,5kW (A2:6)	802	770	421	715	350	12	16x22,5°
HC 71 T4/T6 1,5/0,5kW (A2:9)	802	770	421	715	350	12	16x22,5°
HC 71 T4/T6 1,5/0,5kW (A5:6)	802	770	421	715	350	12	16x22,5°
HC 71 T4/T6 2,2/0,6kW (A2:6)	802	770	452	715	350	12	16x22,5°
HC 71 T4/T6 2,2/0,6kW (A2:9)	802	770	452	715	350	12	16x22,5°
HC 71 T4/T6 2,2/0,6kW (A5:6)	802	770	452	715	350	12	16x22,5°
HC 71 T4/T6 3/0,9kW (A2:6)	802	770	452	715	350	12	16x22,5°
HC 71 T4/T6 3/0,9kW (A2:9)	802	770	452	715	350	12	16x22,5°
HC 71 T4/T6 3/0,9kW (A5:6)	802	770	452	715	350	12	16x22,5°
HC 71 T4/T8 0,75/0,12kW (A2:6)	802	770	362	715	350	12	16x22,5°
HC 71 T4/T8 0,75/0,12kW (A5:6)	802	770	362	715	350	12	16x22,5°
HC 71 T4/T8 1,1/0,18kW (A2:6)	802	770	396	715	350	12	16x22,5°
HC 71 T4/T8 1,1/0,18kW (A2:9)	802	770	396	715	350	12	16x22,5°
HC 71 T4/T8 1,1/0,18kW (A5:6)	802	770	396	715	350	12	16x22,5°
HC 71 T4/T8 1,5/0,25kW (A2:6)	802	770	421	715	350	12	16x22,5°
HC 71 T4/T8 1,5/0,25kW (A2:9)	802	770	421	715	350	12	16x22,5°
HC 71 T4/T8 1,5/0,25kW (A5:6)	802	770	421	715	350	12	16x22,5°
HC 71 T4/T8 2,2/0,37kW (A2:6)	802	770	452	715	350	12	16x22,5°
HC 71 T4/T8 2,2/0,37kW (A2:9)	802	770	452	715	350	12	16x22,5°
HC 71 T4/T8 2,2/0,37kW (A5:6)	802	770	452	715	350	12	16x22,5°
HC 71 T4/T8 3/0,55kW (A2:6)	802	770	452	715	350	12	16x22,5°
HC 71 T4/T8 3/0,55kW (A2:9)	802	770	452	715	350	12	16x22,5°
HC 71 T4/T8 3/0,55kW (A5:6)	802	770	452	715	350	12	16x22,5°
HC 80 T4 1,1KW (A2:6)	892	860	445	801	350	12	16x22,5°
HC 80 T4 1,5KW (A2:6)	892	860	445	801	350	12	16x22,5°
HC 80 T4 1,5KW (A2:9)	892	860	445	801	350	12	16x22,5°
HC 80 T4 2,2kW (A2:6)	892	860	445	801	350	12	16x22,5°
HC 80 T4 2,2kW (A2:9)	892	860	477	801	350	12	16x22,5°

Model	ØA	ØB	C'	ØDint	E	ØJ	O
HC 80 T4 3kW (A2:6)	892	860	476	801	350	12	16x22,5°
HC 80 T4 3kW (A2:9)	892	860	533	801	350	12	16x22,5°
HC 80 T4 3kW (A5:6)	892	860	476	801	350	12	16x22,5°
HC 80 T4 4kW (A2:6)	892	860	477	801	350	12	16x22,5°
HC 80 T4 4kW (A2:9)	892	860	571	801	350	12	16x22,5°
HC 80 T4 4kW (A5:6)	892	860	476	801	350	12	16x22,5°
HC 80 T4 5,5kW (A2:6)	892	860	533	801	350	12	16x22,5°
HC 80 T4 5,5kW (A2:9)	892	860	571	801	350	12	16x22,5°
HC 80 T6 0,75kW (A2:6)	892	860	445	801	350	12	16x22,5°
HC 80 T6 0,75kW (A2:9)	892	860	445	801	350	12	16x22,5°
HC 80 T6 0,75kW (A5:6)	892	860	445	801	350	12	16x22,5°
HC 80 T6 1,1kW (A2:6)	892	860	445	801	350	12	16x22,5°
HC 80 T6 1,1kW (A2:9)	892	860	445	801	350	12	16x22,5°
HC 80 T6 1,1kW (A5:6)	892	860	445	801	350	12	16x22,5°
HC 80 T6 1,5kW (A2:6)	892	860	476	801	350	12	16x22,5°
HC 80 T6 1,5kW (A2:9)	892	860	476	801	350	12	16x22,5°
HC 80 T6 1,5kW (A5:6)	892	860	476	801	350	12	16x22,5°
HC 80 T6 2,2kW (A2:9)	892	860	477	801	350	12	16x22,5°
HC 80 T6 2,2kW (A5:6)	892	860	477	801	350	12	16x22,5°
HC 80 T4/T6 1,1/0,37kW (A2:6)	892	860	445	801	350	12	16x22,5°
HC 80 T4/T6 1,5/0,5kW (A2:6)	892	860	445	801	350	12	16x22,5°
HC 80 T4/T6 1,5/0,5kW (A2:9)	892	860	445	801	350	12	16x22,5°
HC 80 T4/T6 2,2/0,6kW (A2:6)	892	860	445	801	350	12	16x22,5°
HC 80 T4/T6 2,2/0,6kW (A2:9)	892	860	477	801	350	12	16x22,5°
HC 80 T4/T6 3/0,9kW (A2:6)	892	860	476	801	350	12	16x22,5°
HC 80 T4/T6 3/0,9kW (A2:9)	892	860	533	801	350	12	16x22,5°
HC 80 T4/T6 3/0,9kW (A5:6)	892	860	476	801	350	12	16x22,5°
HC 80 T4/T6 4/1,1kW (A2:6)	892	860	477	801	350	12	16x22,5°
HC 80 T4/T6 4/1,1kW (A2:9)	892	860	571	801	350	12	16x22,5°
HC 80 T4/T6 4/1,1kW (A5:6)	892	860	476	801	350	12	16x22,5°
HC 80 T4/T6 5,5/1,85kW (A2:6)	892	860	533	801	350	12	16x22,5°
HC 80 T4/T6 5,5/1,85kW (A2:9)	892	860	571	801	350	12	16x22,5°
HC 80 T4/T8 1,1/0,18kW (A2:6)	892	860	445	801	350	12	16x22,5°
HC 80 T4/T8 1,5/0,25kW (A2:6)	892	860	445	801	350	12	16x22,5°
HC 80 T4/T8 1,5/0,25kW (A2:9)	892	860	445	801	350	12	16x22,5°
HC 80 T4/T8 2,2/0,37kW (A2:6)	892	860	476	801	350	12	16x22,5°
HC 80 T4/T8 2,2/0,37kW (A2:9)	892	860	476	801	350	12	16x22,5°
HC 80 T4/T8 3/0,55kW (A2:6)	892	860	476	801	350	12	16x22,5°
HC 80 T4/T8 3/0,55kW (A2:9)	892	860	476	801	350	12	16x22,5°
HC 80 T4/T8 3/0,55kW (A5:6)	892	860	476	801	350	12	16x22,5°

Model	ØA	ØB	C'	ØDint	E	ØJ	O
HC 80 T4/T8 4/0,75kW (A2:6)	892	860	477	801	350	12	16X22,5°
HC 80 T4/T8 4/0,75kW (A2:9)	892	860	477	801	350	12	16X22,5°
HC 80 T4/T8 4/0,75kW (A5:6)	892	860	476	801	350	12	16x22,5°
HC 80 T4/T8 5,5/1,1kW (A2:6)	892	860	533	801	350	12	16X22,5°
HC 80 T4/T8 5,5/1,1kW (A2:9)	892	860	533	801	350	12	16X22,5°
HC 90 T4 3kW (A6:3)	1000	970	655	903,5	425	12	16X22,5°
HC 90 T4 4kW (A6:3)	1000	970	655	903,5	425	12	16X22,5°
HC 90 T4 5,5kW (A6:3)	1000	970	655	903,5	425	12	16X22,5°
HC 90 T4 5,5kW (A6:6)	1000	970	655	903,5	425	12	16X22,5°
HC 90 T4 7,5kW (A6:3)	1000	970	655	903,5	425	12	16X22,5°
HC 90 T4 7,5kW (A6:6)	1000	970	655	903,5	425	12	16X22,5°
HC 90 T4 11kW (A6:3)	1000	970	718	903,5	425	12	16X22,5°
HC 90 T4 11kW (A6:6)	1000	970	718	903,5	425	12	16X22,5°
HC 90 T4 15kW (A6:6)	1000	970	762	903,5	425	12	16X22,5°
HC 90 T6 1,5kW (A6:3)	1000	970	655	903,5	425	12	16X22,5°
HC 90 T6 1,5kW (A6:6)	1000	970	655	903,5	425	12	16X22,5°
HC 90 T6 2,2kW (A6:3)	1000	970	655	903,5	425	12	16X22,5°
HC 90 T6 2,2kW (A6:6)	1000	970	655	903,5	425	12	16X22,5°
HC 90 T6 3kW (A6:3)	1000	970	655	903,5	425	12	16X22,5°
HC 90 T6 3kW (A6:6)	1000	970	655	903,5	425	12	16X22,5°
HC 90 T6 4kW (A6:6)	1000	970	655	903,5	425	12	16X22,5°
HC 90 T4/T6 3/0,9kW (A6:3)	1000	970	655	903,5	425	12	16X22,5°
HC 90 T4/T6 4/1,1kW (A6:3)	1000	970	655	903,5	425	12	16X22,5°
HC 90 T4/T6 5,5/1,85kW (A6:3)	1000	970	655	903,5	425	12	16X22,5°
HC 90 T4/T6 5,5/1,85kW (A6:6)	1000	970	655	903,5	425	12	16X22,5°
HC 90 T4/T6 7,5/2,2kW (A6:3)	1000	970	655	903,5	425	12	16X22,5°
HC 90 T4/T6 7,5/2,2kW (A6:6)	1000	970	655	903,5	425	12	16X22,5°
HC 90 T4/T6 11/3,6kW (A6:3)	1000	970	718	903,5	425	12	16X22,5°
HC 90 T4/T6 11/3,6kW (A6:6)	1000	970	718	903,5	425	12	16X22,5°
HC 90 T4/T6 15/4,4kW (A6:6)	1000	970	762	903,5	425	12	16X22,5°
HC 90 T4/T8 3/0,55kW (A6:3)	1000	970	655	903,5	425	12	16X22,5°
HC 90 T4/T8 4/0,75kW (A6:3)	1000	970	655	903,5	425	12	16X22,5°
HC 90 T4/T8 5,5/1,1kW (A6:3)	1000	970	655	903,5	425	12	16X22,5°
HC 90 T4/T8 5,5/1,1kW (A6:6)	1000	970	655	903,5	425	12	16X22,5°
HC 90 T4/T8 7,5/1,5kW (A6:3)	1000	970	655	903,5	425	12	16X22,5°
HC 90 T4/T8 7,5/1,5kW (A6:6)	1000	970	655	903,5	425	12	16X22,5°
HC 90 T4/T8 11/3kW (A6:3)	1000	970	762	903,5	425	12	16X22,5°
HC 90 T4/T8 11/3kW (A6:6)	1000	970	762	903,5	425	12	16X22,5°
HC 90 T4/T8 15/3,5kW (A6:6)	1000	970	718	903,5	425	12	16X22,5°
HC 100 T4 5,5kW (A6:3)	1115	1070	655	1013	425	12	16x22,5°

Model	ØA	ØB	C'	ØDint	E	ØJ	O
HC 100 T4 7,5kW (A6:3)	1115	1070	655	1013	425	12	16x22,5°
HC 100 T4 7,5kW (A6:6)	1115	1070	655	1013	425	12	16x22,5°
HC 100 T4 11kW (A6:3)	1115	1070	718	1013	425	12	16x22,5°
HC 100 T4 11kW (A6:6)	1115	1070	718	1013	425	12	16x22,5°
HC 100 T4 15kW (A6:3)	1115	1070	762	1013	425	12	16x22,5°
HC 100 T4 15kW (A6:6)	1115	1070	762	1013	425	12	16x22,5°
HC 100 T4 18,5kW (A6:6)	1115	1070	756	1013	425	12	16x22,5°
HC 100 T4 22kW (A6:6)	1115	1070	794	1013	425	12	16x22,5°
HC 100 T6 1,5kW (A6:3)	1115	1070	655	1013	425	12	16x22,5°
HC 100 T6 2,2kW (A6:3)	1115	1070	655	1013	425	12	16x22,5°
HC 100 T6 2,2kW (A6:6)	1115	1070	655	1013	425	12	16x22,5°
HC 100 T6 3kW (A6:3)	1115	1070	655	1013	425	12	16x22,5°
HC 100 T6 3kW (A6:6)	1115	1070	655	1013	425	12	16x22,5°
HC 100 T6 4kW (A6:3)	1115	1070	655	1013	425	12	16x22,5°
HC 100 T6 4kW (A6:6)	1115	1070	655	1013	425	12	16x22,5°
HC 100 T6 5,5kW (A6:6)	1115	1070	655	1013	425	12	16x22,5°
HC 100 T6 7,5kW (A6:6)	1115	1070	718	1013	425	12	16x22,5°
HC 100 T4/T6 5,5/1,85kW (A6:3)	1115	1070	655	1013	425	12	16x22,5°
HC 100 T4/T6 7,5/2,2kW (A6:3)	1115	1070	655	1013	425	12	16x22,5°
HC 100 T4/T6 7,5/2,2kW (A6:6)	1115	1070	655	1013	425	12	16x22,5°
HC 100 T4/T6 11/3,6kW (A6:3)	1115	1070	718	1013	425	12	16x22,5°
HC 100 T4/T6 11/3,6kW (A6:6)	1115	1070	718	1013	425	12	16x22,5°
HC 100 T4/T6 15/4,4kW (A6:3)	1115	1070	762	1013	425	12	16x22,5°
HC 100 T4/T6 15/4,4kW (A6:6)	1115	1070	762	1013	425	12	16x22,5°
HC 100 T4/T6 18,5/6kW (A6:6)	1115	1070	756	1013	425	12	16x22,5°
HC 100 T4/T6 22/7,5kW (A6:6)	1115	1070	794	1013	425	12	16x22,5°
HC 100 T4/T8 5,5/1,1kW (A6:3)	1115	1070	655	1013	425	12	16x22,5°
HC 100 T4/T8 7,5/1,5kW (A6:3)	1115	1070	655	1013	425	12	16x22,5°
HC 100 T4/T8 7,5/1,5kW (A6:6)	1115	1070	655	1013	425	12	16x22,5°
HC 100 T4/T8 11/3kW (A6:3)	1115	1070	762	1013	425	12	16x22,5°
HC 100 T4/T8 11/3kW (A6:6)	1115	1070	762	1013	425	12	16x22,5°
HC 100 T4/T8 15/3,5kW (A6:3)	1115	1070	718	1013	425	12	16x22,5°
HC 100 T4/T8 15/3,5kW (A6:6)	1115	1070	718	1013	425	12	16x22,5°
HC 100 T4/T8 17/4,3kW (A6:6)	1115	1070	756	1013	425	12	16x22,5°
HC 100 T4/T8 20/5kW (A6:6)	1115	1070	794	1013	425	12	16x22,5°
HC 112 T4 5,5kW (A6:3)	1234	1190	765	1132	500	12	16x22,5°
HC 112 T4 7,5kW (A6:3)	1234	1190	765	1132	500	12	16x22,5°
HC 112 T4 11kW (A6:3)	1234	1190	765	1132	500	12	16x22,5°
HC 112 T4 11kW (A6:6)	1234	1190	765	1132	500	12	16x22,5°
HC 112 T4 15kW (A6:3)	1234	1190	772	1132	500	12	16x22,5°

Model	ØA	ØB	C'	ØDint	E	ØJ	O
HC 112 T4 15kW (A6:6)	1234	1190	772	1132	500	12	16x22,5°
HC 112 T4 18,5kW (A6:3)	1234	1190	766	1132	500	12	16x22,5°
HC 112 T4 18,5kW (A6:6)	1234	1190	766	1132	500	12	16x22,5°
HC 112 T4 22kW (A6:3)	1234	1190	804	1132	500	12	16x22,5°
HC 112 T4 22kW (A6:6)	1234	1190	804	1132	500	12	16x22,5°
HC 112 T4 30kW (A6:6)	1234	1190	869	1132	500	12	16x22,5°
HC 112 T6 2,2kW (A6:3)	1234	1190	765	1132	500	12	16x22,5°
HC 112 T6 2,2kW (A6:6)	1234	1190	765	1132	500	12	16x22,5°
HC 112 T6 3kW (A6:3)	1234	1190	765	1132	500	12	16x22,5°
HC 112 T6 3kW (A6:6)	1234	1190	765	1132	500	12	16x22,5°
HC 112 T6 4kW (A6:3)	1234	1190	765	1132	500	12	16x22,5°
HC 112 T6 4kW (A6:6)	1234	1190	765	1132	500	12	16x22,5°
HC 112 T6 5,5kW (A6:3)	1234	1190	765	1132	500	12	16x22,5°
HC 112 T6 5,5kW (A6:6)	1234	1190	765	1132	500	12	16x22,5°
HC 112 T6 7,5kW (A6:6)	1234	1190	765	1132	500	12	16x22,5°
HC 112 T6 11kW (A6:6)	1234	1190	772	1132	500	12	16x22,5°
HC 112 T4/T6 5,5/1,85kW (A6:3)	1234	1190	765	1132	500	12	16x22,5°
HC 112 T4/T6 7,5/2,2kW (A6:3)	1234	1190	765	1132	500	12	16x22,5°
HC 112 T4/T6 11/3,6kW (A6:3)	1234	1190	765	1132	500	12	16x22,5°
HC 112 T4/T6 11/3,6kW (A6:6)	1234	1190	765	1132	500	12	16x22,5°
HC 112 T4/T6 15/4,4kW (A6:3)	1234	1190	772	1132	500	12	16x22,5°
HC 112 T4/T6 15/4,4kW (A6:6)	1234	1190	772	1132	500	12	16x22,5°
HC 112 T4/T6 18,5/6kW (A6:3)	1234	1190	766	1132	500	12	16x22,5°
HC 112 T4/T6 18,5/6kW (A6:6)	1234	1190	766	1132	500	12	16x22,5°
HC 112 T4/T6 22/7,5kW (A6:3)	1234	1190	804	1132	500	12	16x22,5°
HC 112 T4/T6 22/7,5kW (A6:6)	1234	1190	804	1132	500	12	16x22,5°
HC 112 T4/T8 5,5/1,1kW (A6:3)	1234	1190	765	1132	500	12	16x22,5°
HC 112 T4/T8 7,5/1,5kW (A6:3)	1234	1190	765	1132	500	12	16x22,5°
HC 112 T4/T8 11/3kW (A6:3)	1234	1190	772	1132	500	12	16x22,5°
HC 112 T4/T8 11/3kW (A6:6)	1234	1190	772	1132	500	12	16x22,5°
HC 112 T4/T8 15/3,5kW (A6:3)	1234	1190	765	1132	500	12	16x22,5°
HC 112 T4/T8 15/3,5kW (A6:6)	1234	1190	765	1132	500	12	16x22,5°
HC 112 T4/T8 17/4,3kW (A6:3)	1234	1190	766	1132	500	12	16x22,5°
HC 112 T4/T8 17/4,3kW (A6:6)	1234	1190	766	1132	500	12	16x22,5°
HC 112 T4/T8 20/5kW (A6:3)	1234	1190	804	1132	500	12	16x22,5°
HC 112 T4/T8 20/5kW (A6:6)	1234	1190	804	1132	500	12	16x22,5°
HC 112 T4/T8 28/6,5kW (A6:6)	1234	1190	869	1132	500	12	16x22,5°
HC 112 T4/T8 35/8kW (A6:6)	1234	1190	869	1132	500	12	16x22,5°
HC 125 T4 11kW (A7:4)	1365	1320	765	1263	500	15	20x18°
HC 125 T4 15kW (A7:4)	1365	1320	772	1263	500	15	20x18°

Model	ØA	ØB	C'	ØDint	E	ØJ	O
HC 125 T4 15kW (A7:8)	1365	1320	772	1263	500	15	20x18°
HC 125 T4 18,5kW (A7:4)	1365	1320	766	1263	500	15	20x18°
HC 125 T4 18,5kW (A7:8)	1365	1320	766	1263	500	15	20x18°
HC 125 T4 22kW (A7:4)	1365	1320	804	1263	500	15	20x18°
HC 125 T4 22kW (A7:8)	1365	1320	804	1263	500	15	20x18°
HC 125 T4 30kW (A7:4)	1365	1320	869	1263	500	15	20x18°
HC 125 T4 30kW (A7:8)	1365	1320	869	1263	500	15	20x18°
HC 125 T4 37kW (A7:4)	1365	1320	954	1263	500	15	20x18°
HC 125 T4 37kW (A7:8)	1365	1320	954	1263	500	15	20x18°
HC 125 T4 45kW (A7:8)	1365	1320	954	1263	500	15	20x18°
HC 125 T6 3kW (A7:4)	1365	1320	765	1263	500	15	20x18°
HC 125 T6 4kW (A7:4)	1365	1320	765	1263	500	15	20x18°
HC 125 T6 5,5kW (A7:4)	1365	1320	765	1263	500	15	20x18°
HC 125 T6 5,5kW (A7:8)	1365	1320	765	1263	500	15	20x18°
HC 125 T6 7,5kW (A7:4)	1365	1320	765	1263	500	15	20x18°
HC 125 T6 7,5kW (A7:8)	1365	1320	765	1263	500	15	20x18°
HC 125 T6 11kW (A7:4)	1365	1320	772	1263	500	15	20x18°
HC 125 T6 11kW (A7:8)	1365	1320	772	1263	500	15	20x18°
HC 125 T6 15kW (A7:8)	1365	1320	804	1263	500	15	20x18°
HC 125 T4/T6 11/3,6kW (A7:4)	1365	1320	765	1263	500	15	20x18°
HC 125 T4/T6 15/4,4kW (A7:4)	1365	1320	772	1263	500	15	20x18°
HC 125 T4/T6 15/4,4kW (A7:8)	1365	1320	772	1263	500	15	20x18°
HC 125 T4/T6 18,5/6kW (A7:4)	1365	1320	766	1263	500	15	20x18°
HC 125 T4/T6 18,5/6kW (A7:8)	1365	1320	766	1263	500	15	20x18°
HC 125 T4/T6 22/7,5kW (A7:4)	1365	1320	804	1263	500	15	20x18°
HC 125 T4/T6 22/7,5kW (A7:8)	1365	1320	804	1263	500	15	20x18°
HC 125 T4/T8 11/3kW (A7:4)	1365	1320	772	1263	500	15	20x18°
HC 125 T4/T8 15/3,5kW (A7:4)	1365	1320	765	1263	500	15	20x18°
HC 125 T4/T8 15/3,5kW (A7:8)	1365	1320	772	1263	500	15	20x18°
HC 125 T4/T8 17/4,3kW (A7:4)	1365	1320	766	1263	500	15	20x18°
HC 125 T4/T8 20/5kW (A7:4)	1365	1320	804	1263	500	15	20x18°
HC 125 T4/T8 20/5kW (A7:8)	1365	1320	804	1263	500	15	20x18°
HC 125 T4/T8 28/6,5kW (A7:4)	1365	1320	869	1263	500	15	20x18°
HC 125 T4/T8 28/6,5kW (A7:8)	1365	1320	869	1263	500	15	20x18°
HC 125 T4/T8 35/8kW (A7:4)	1365	1320	869	1263	500	15	20x18°
HC 125 T4/T8 35/8kW (A7:8)	1365	1320	869	1263	500	15	20x18°
HC 125 T4/T8 37/9,2kW (A7:8)	1365	1320	954	1263	500	15	20x18°
HC 125 T4/T8 44/11kW (A7:8)	1365	1320	954	1263	500	15	20x18°

WIRING DIAGRAM

DIAGRAM Nº 1

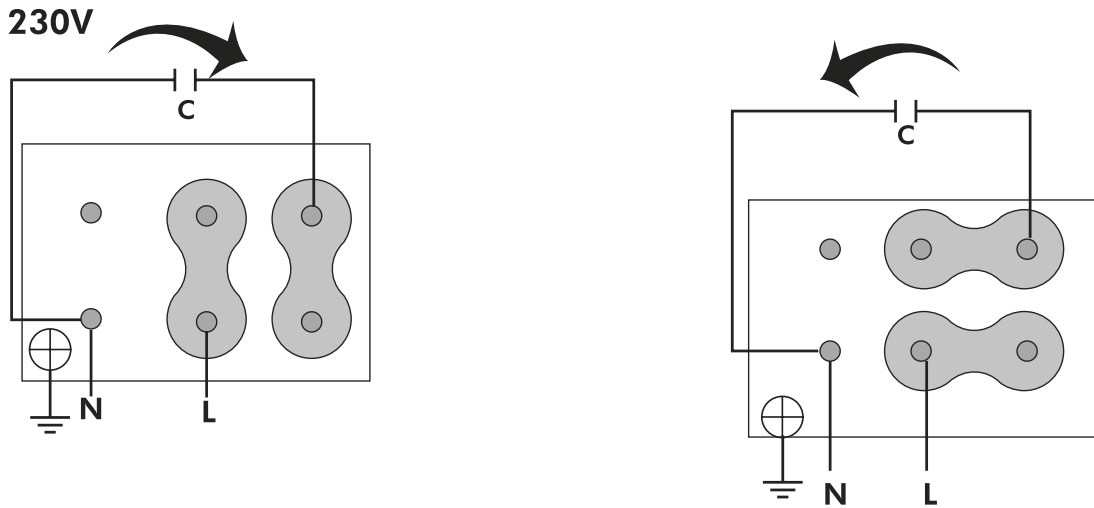

DIAGRAM Nº 2

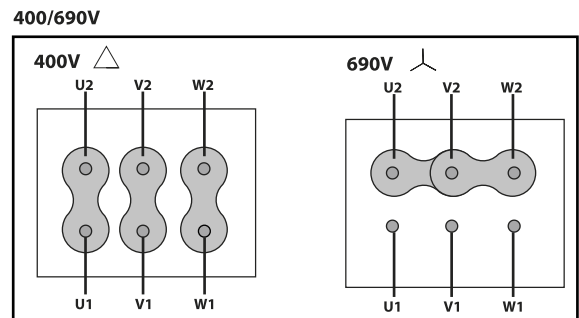
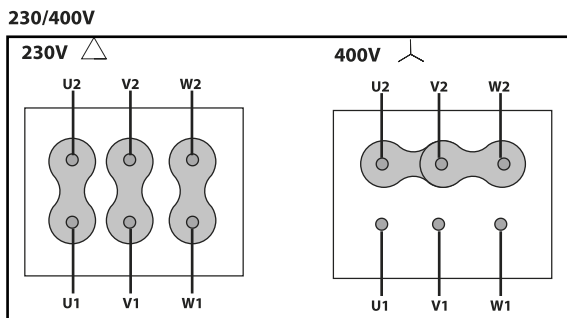

DIAGRAM Nº 3

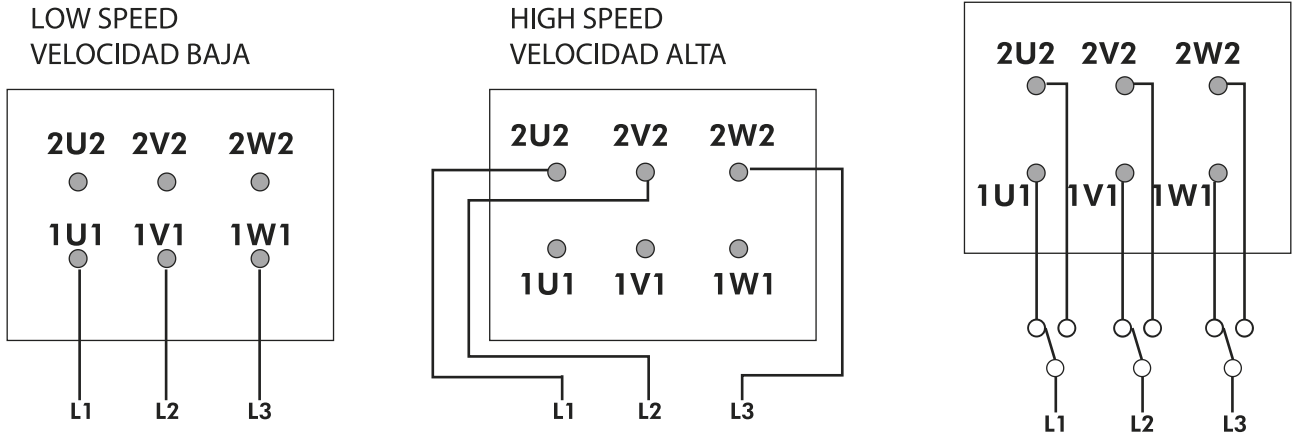
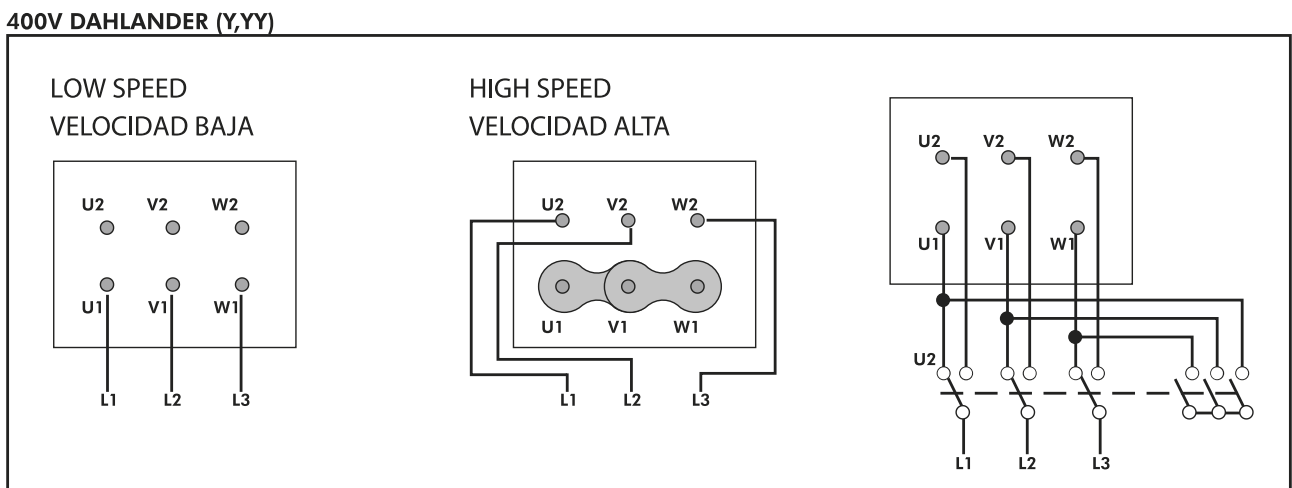

DIAGRAM Nº 4



CHARACTERISTIC CURVE

HC 35 M2 0,55kW (A0:6)

HC 35 M2 1,1kW (A0:6)

AIR FLOW - PRESSURE

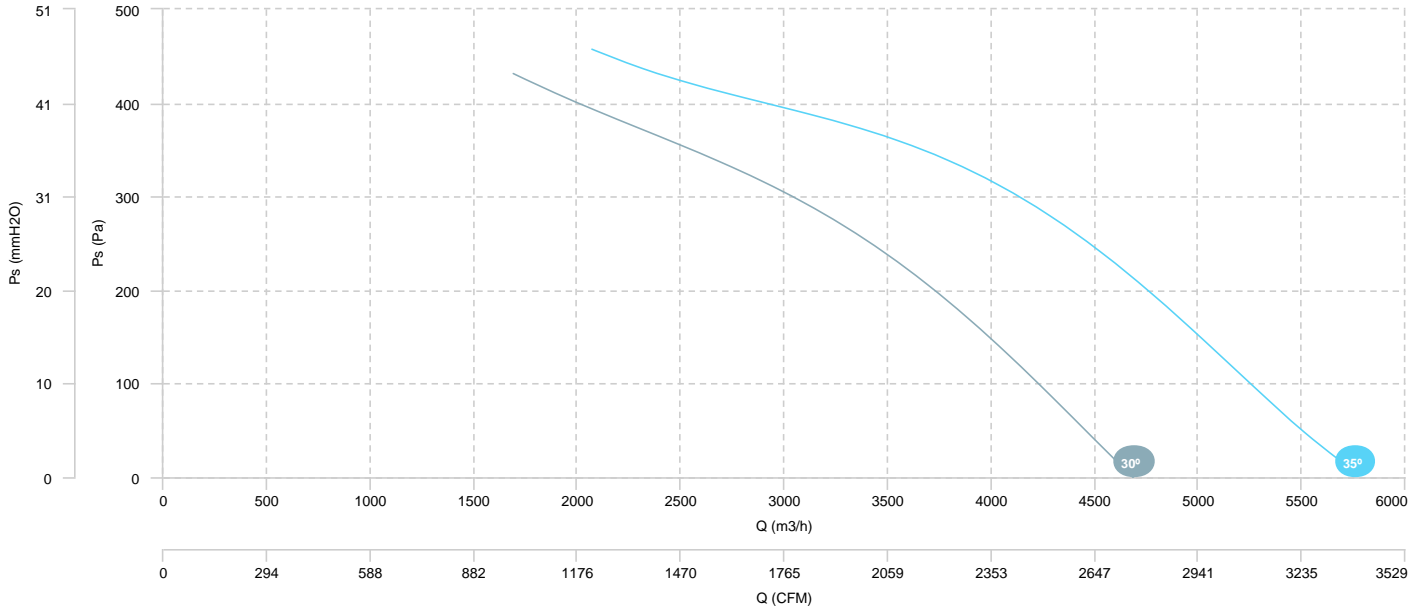

AIR FLOW - ABSORBED POWER

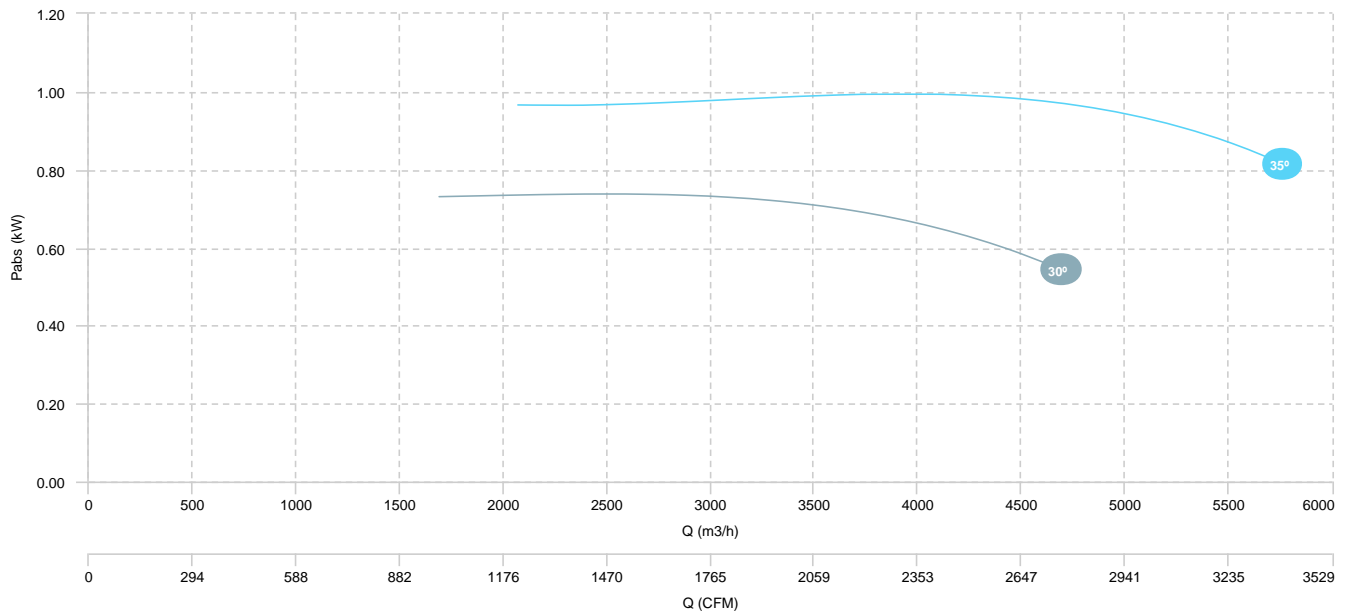

HC 35 M4 0,12kW (A0:6)

AIR FLOW - PRESSURE

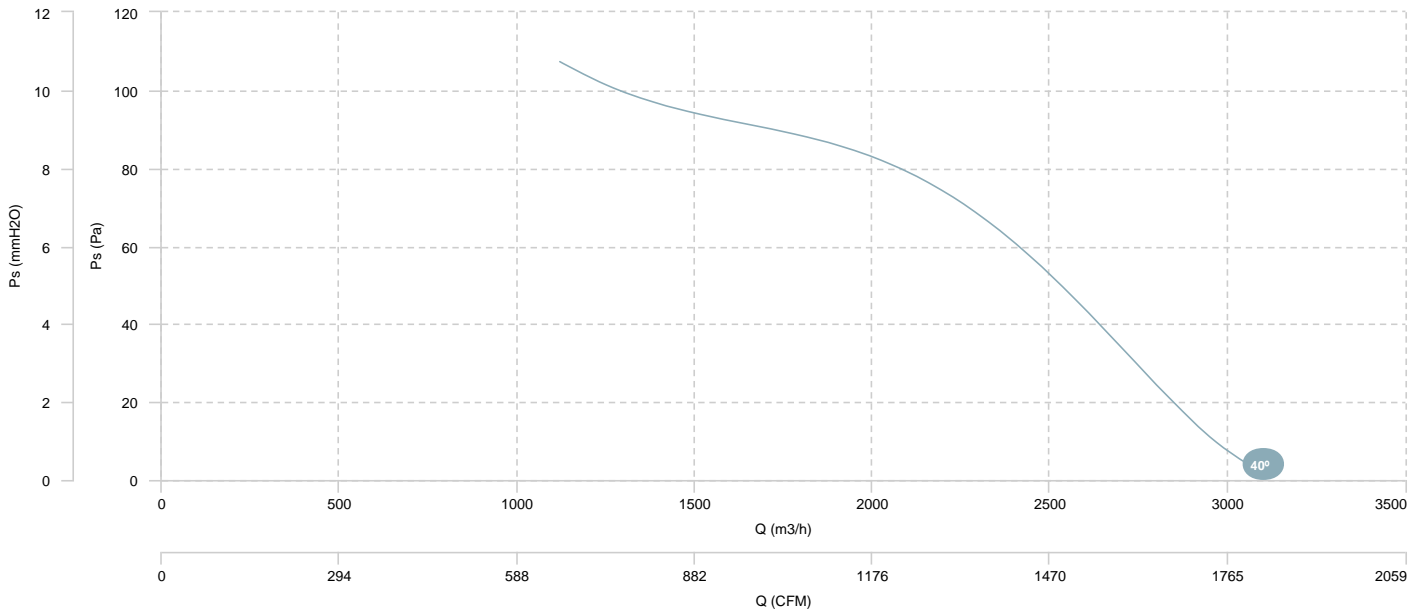

AIR FLOW - ABSORBED POWER

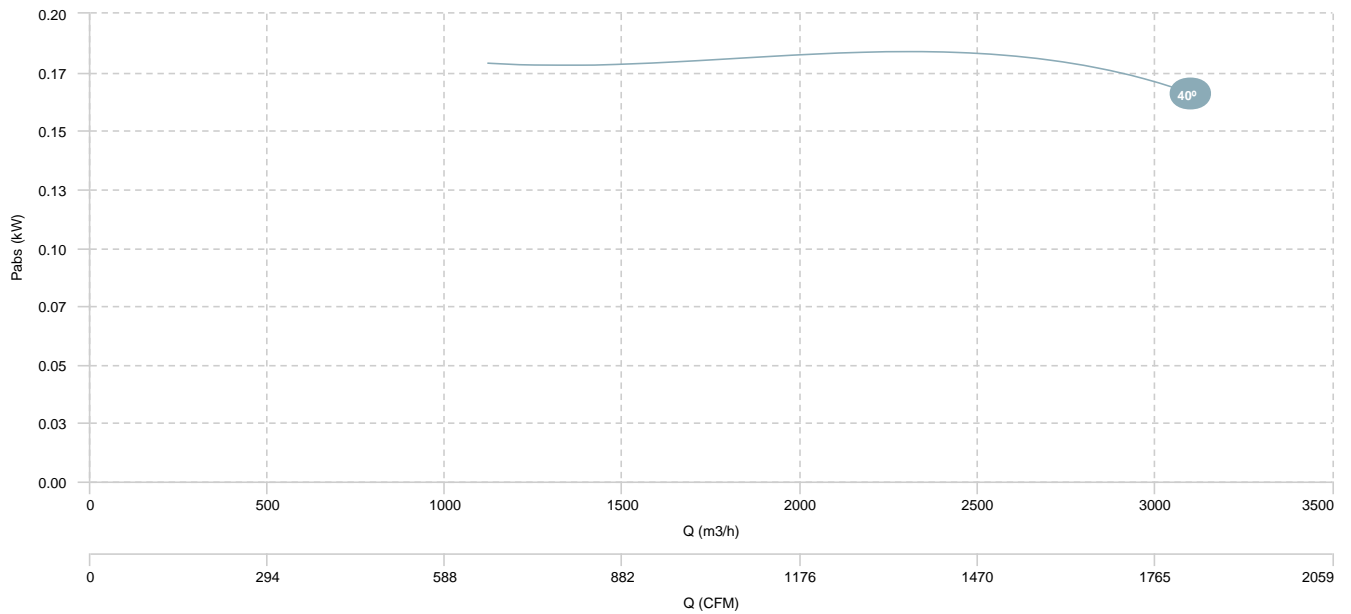

HC 40 M4 0,25kW (A0:6)

AIR FLOW - PRESSURE

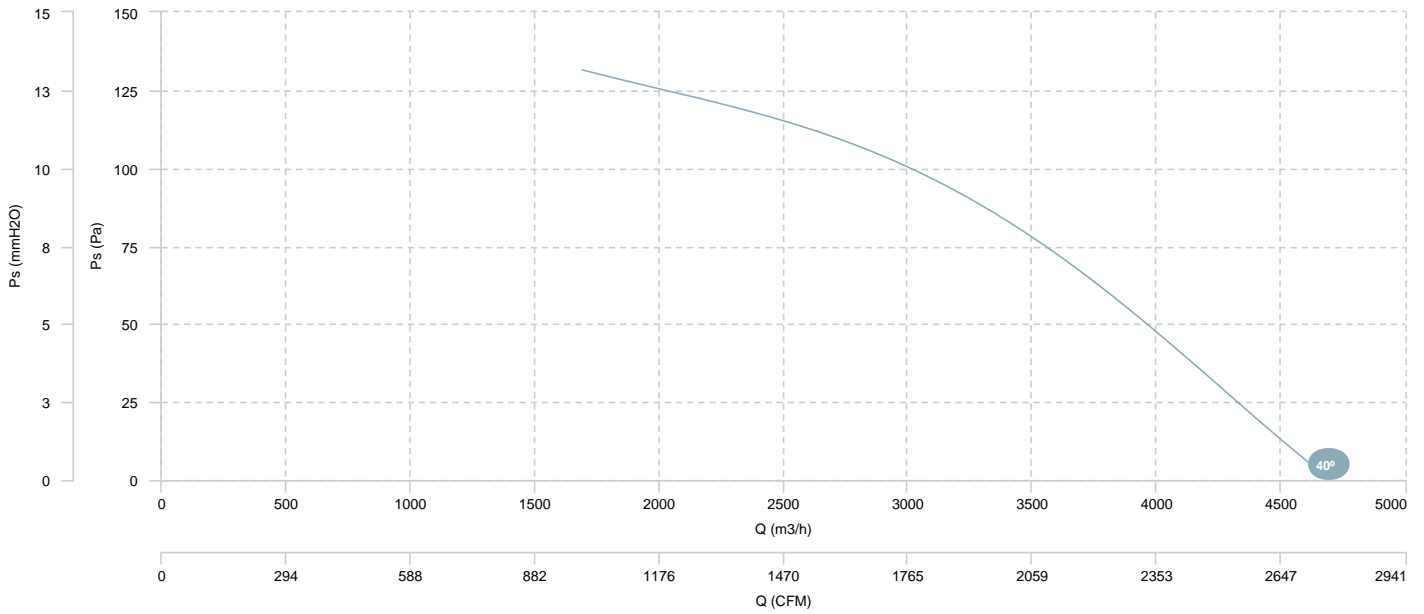

AIR FLOW - ABSORBED POWER

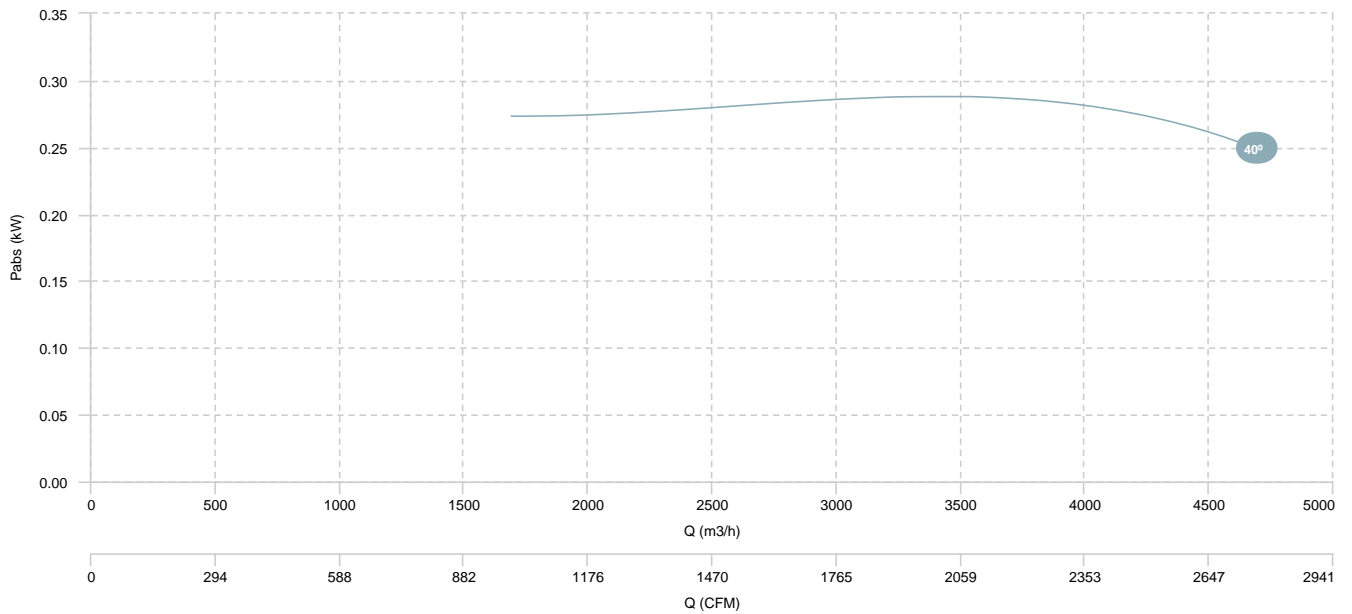

HC 40 M6 0,04kW (A0:6)

AIR FLOW - PRESSURE

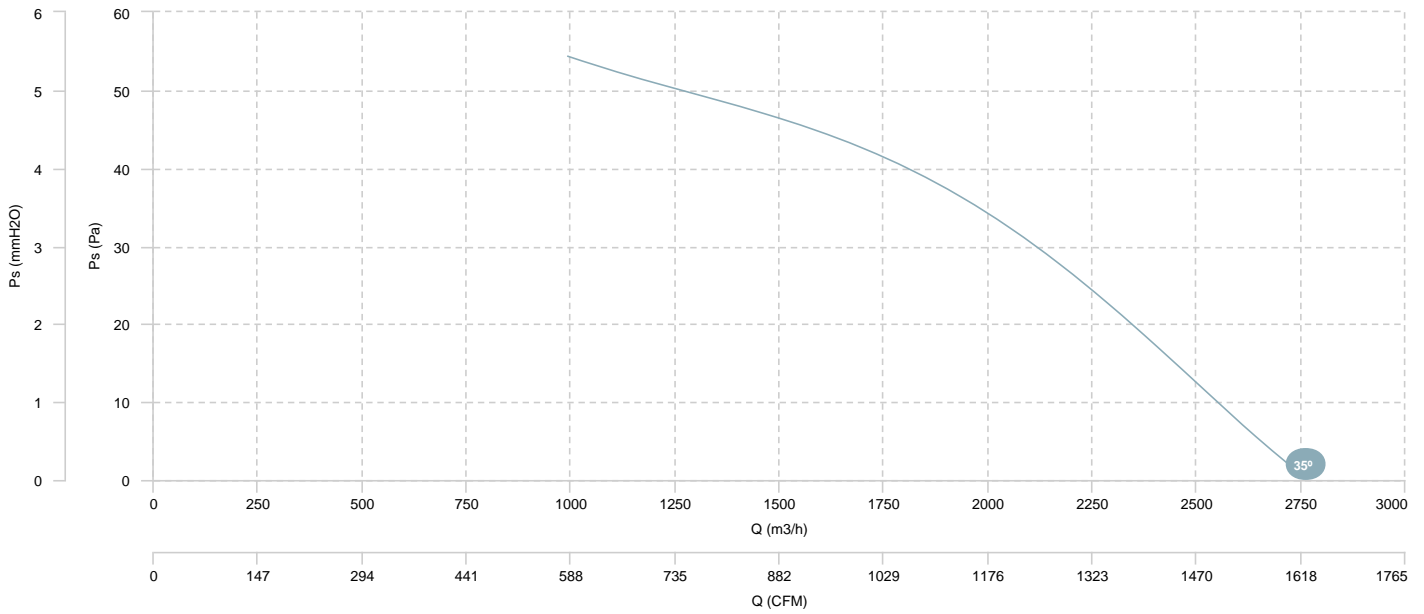

AIR FLOW - ABSORBED POWER

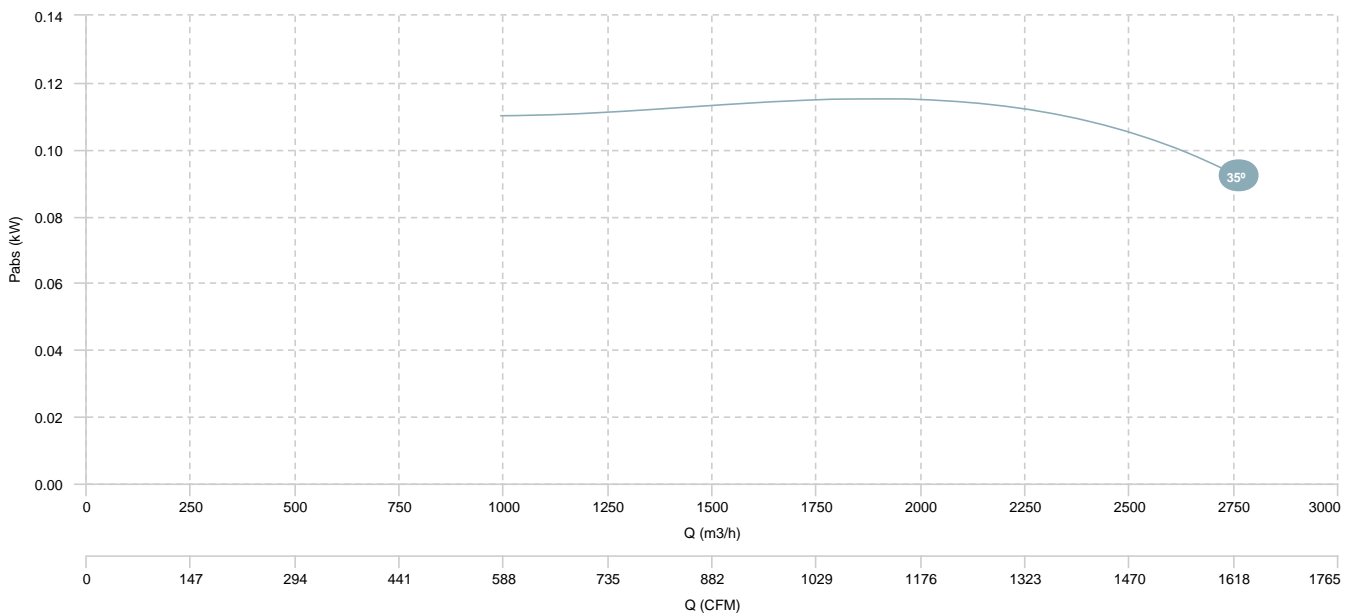

HC 45 M4 0,37kW (A0:6)

AIR FLOW - PRESSURE

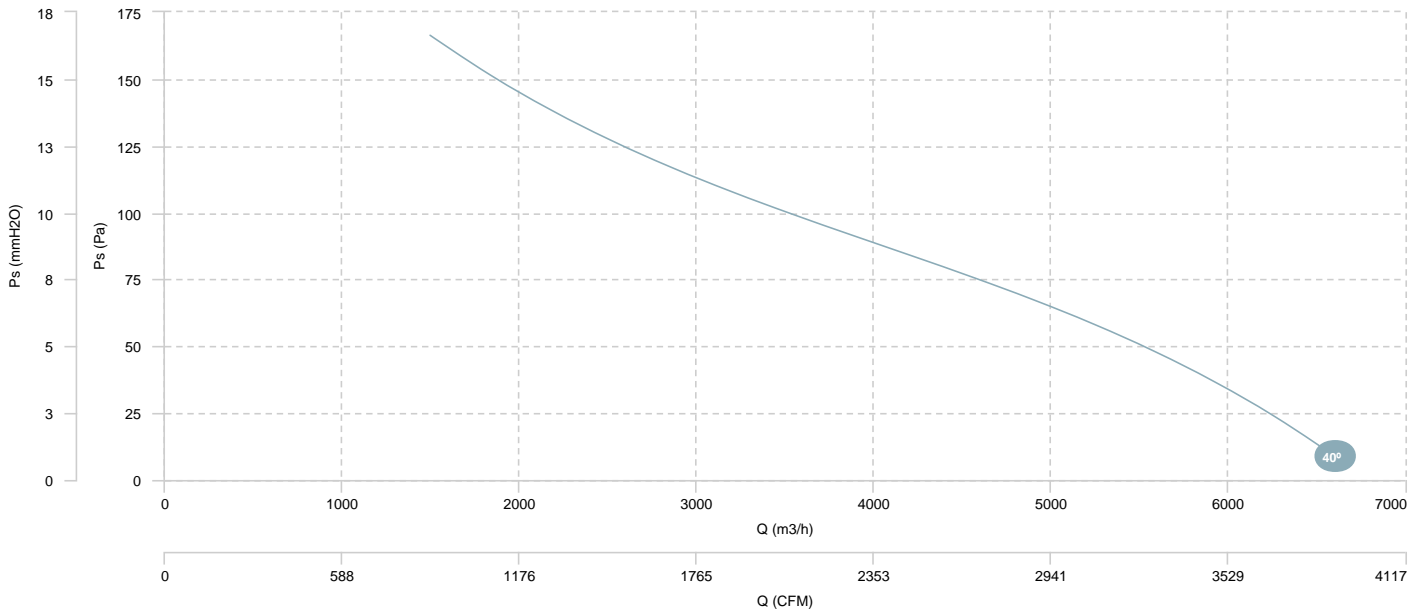

AIR FLOW - ABSORBED POWER

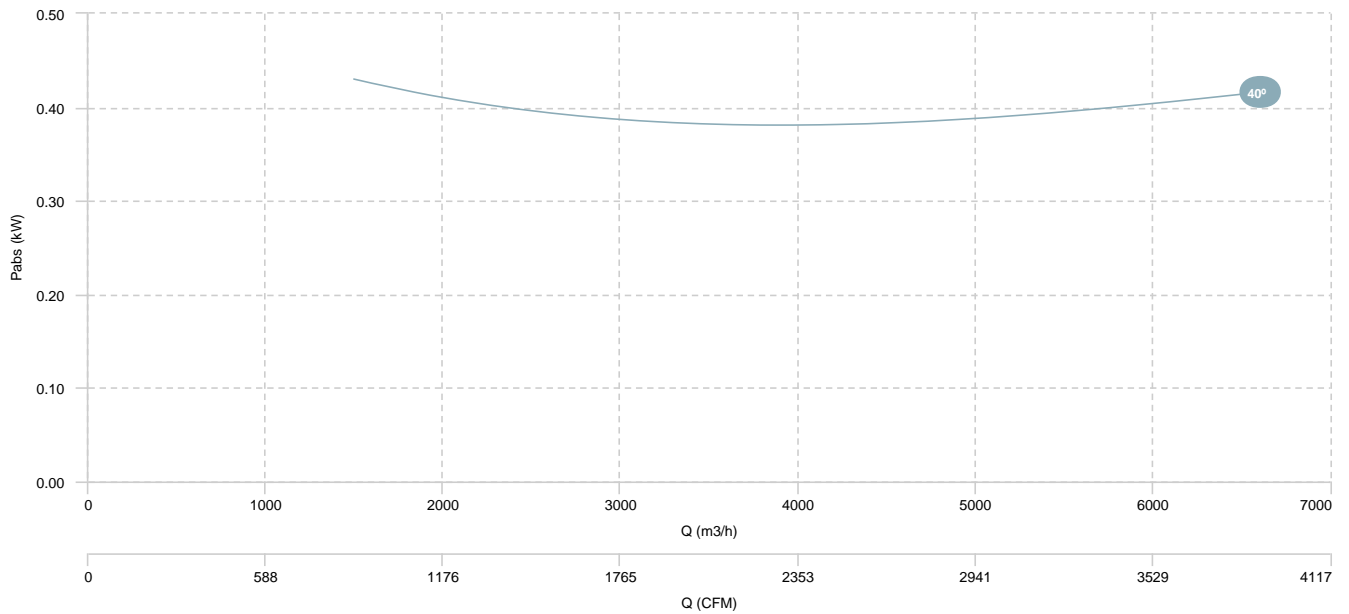

HC 45 M6 0,13kW (A0:6)

AIR FLOW - PRESSURE

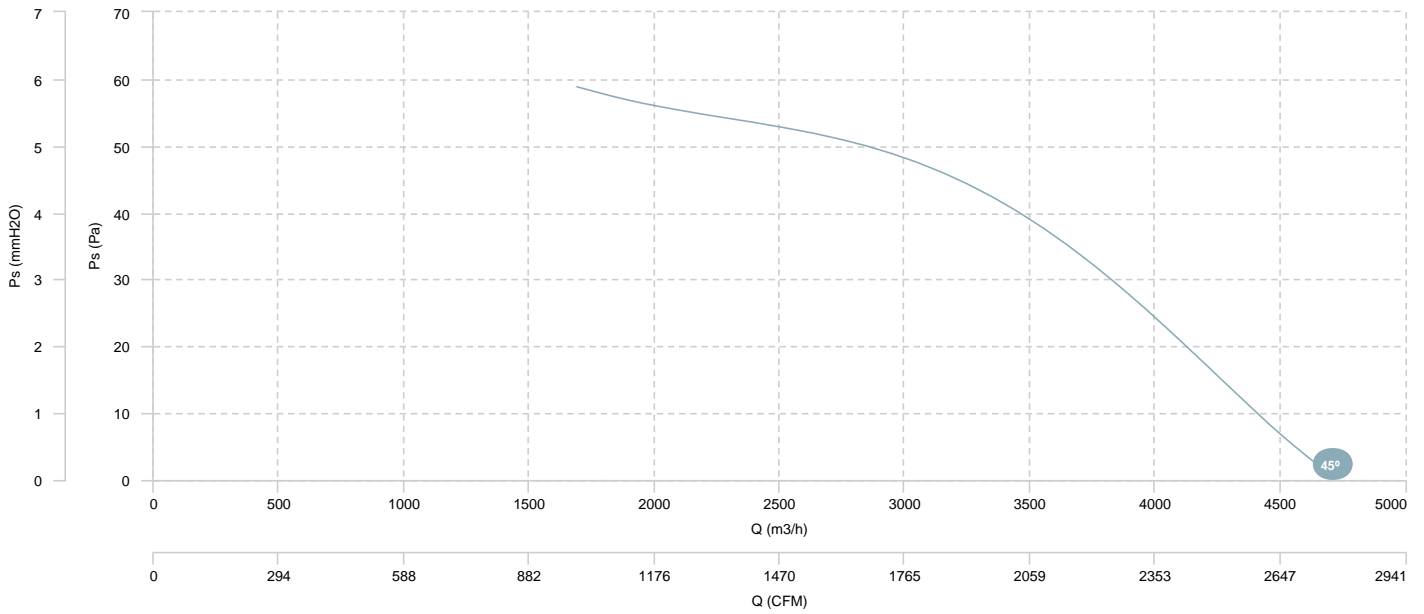

AIR FLOW - ABSORBED POWER

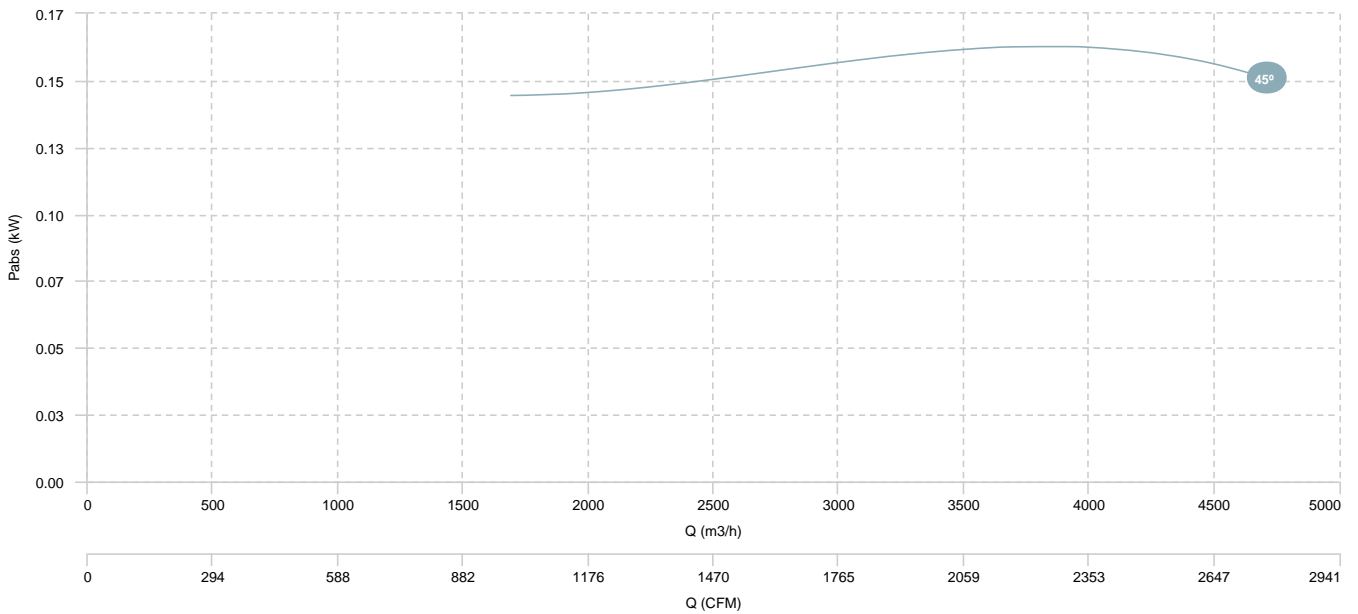

HC 50 M4 0,55kW (A0:6)

AIR FLOW - PRESSURE

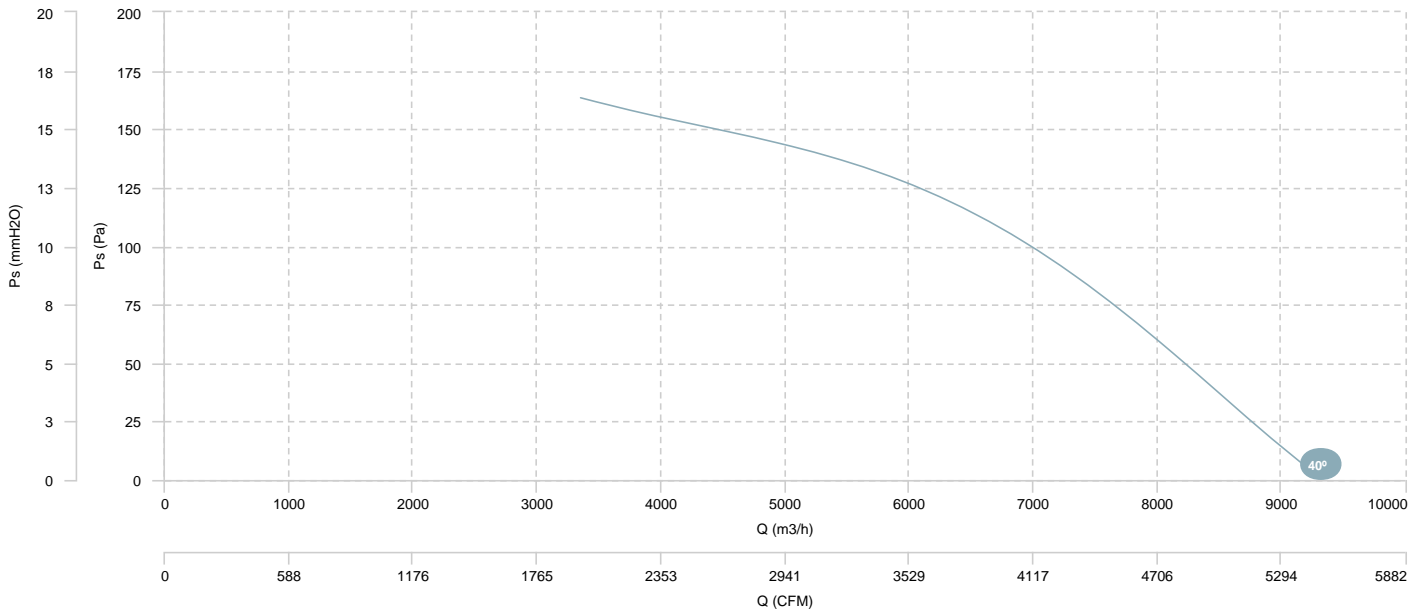

AIR FLOW - ABSORBED POWER

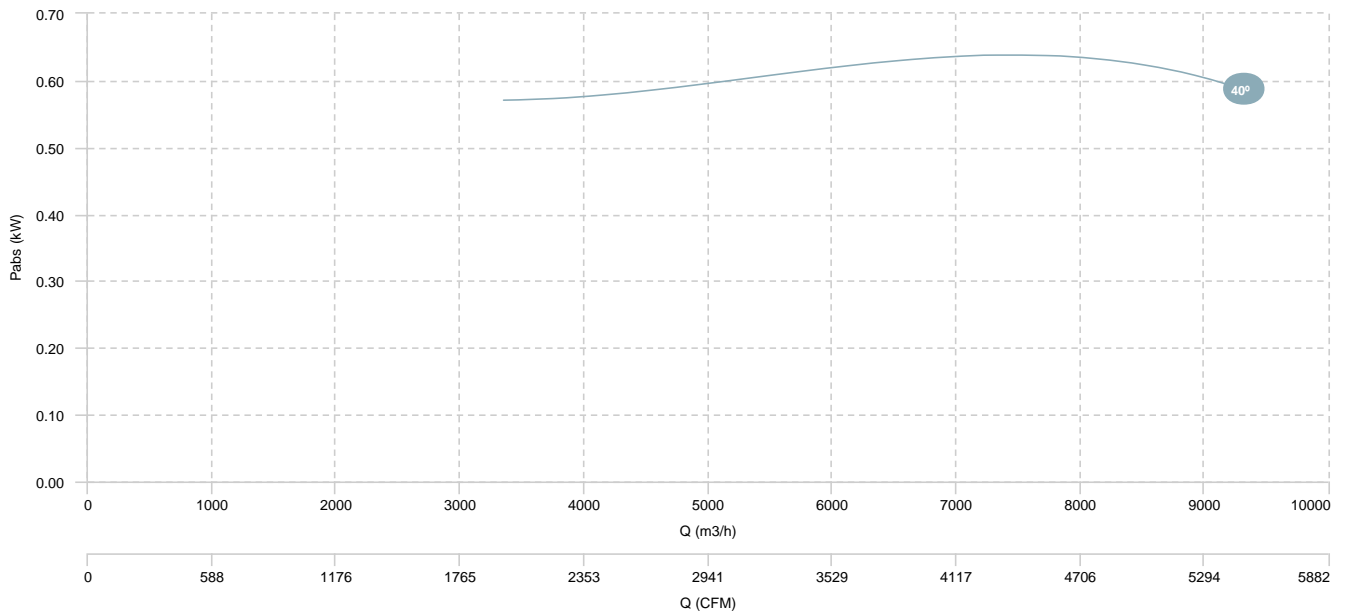

HC 50 M6 0,13kW (A0:6)

AIR FLOW - PRESSURE

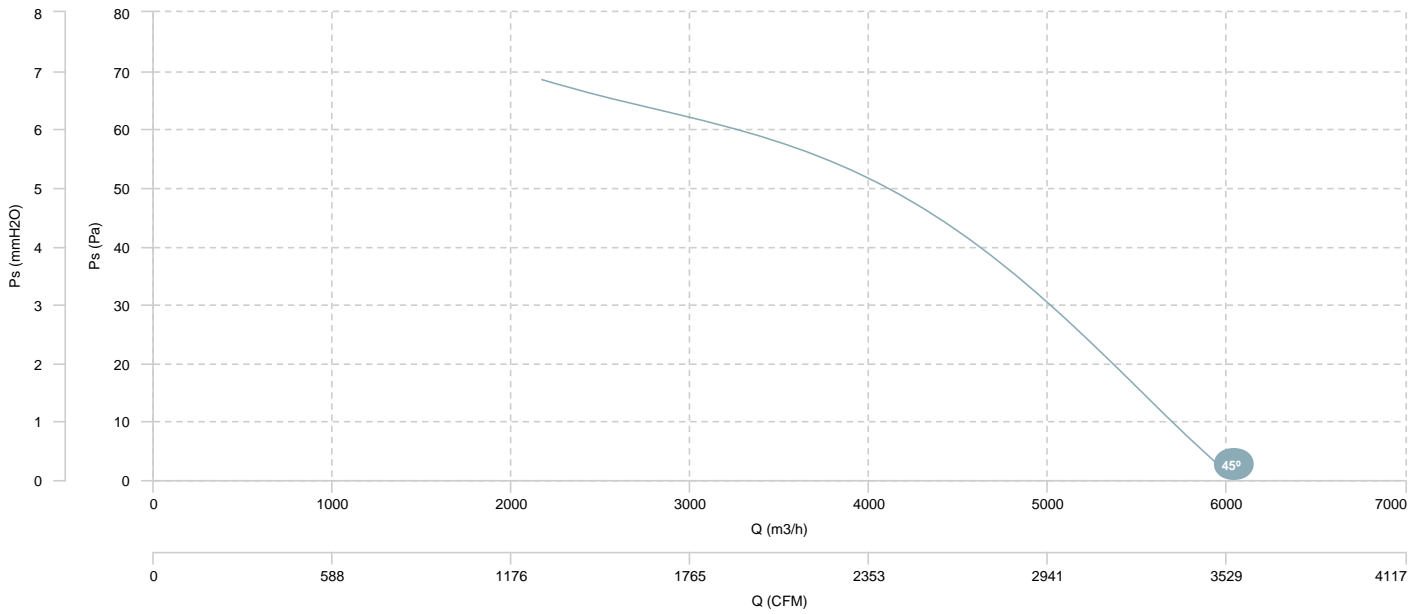

AIR FLOW - ABSORBED POWER

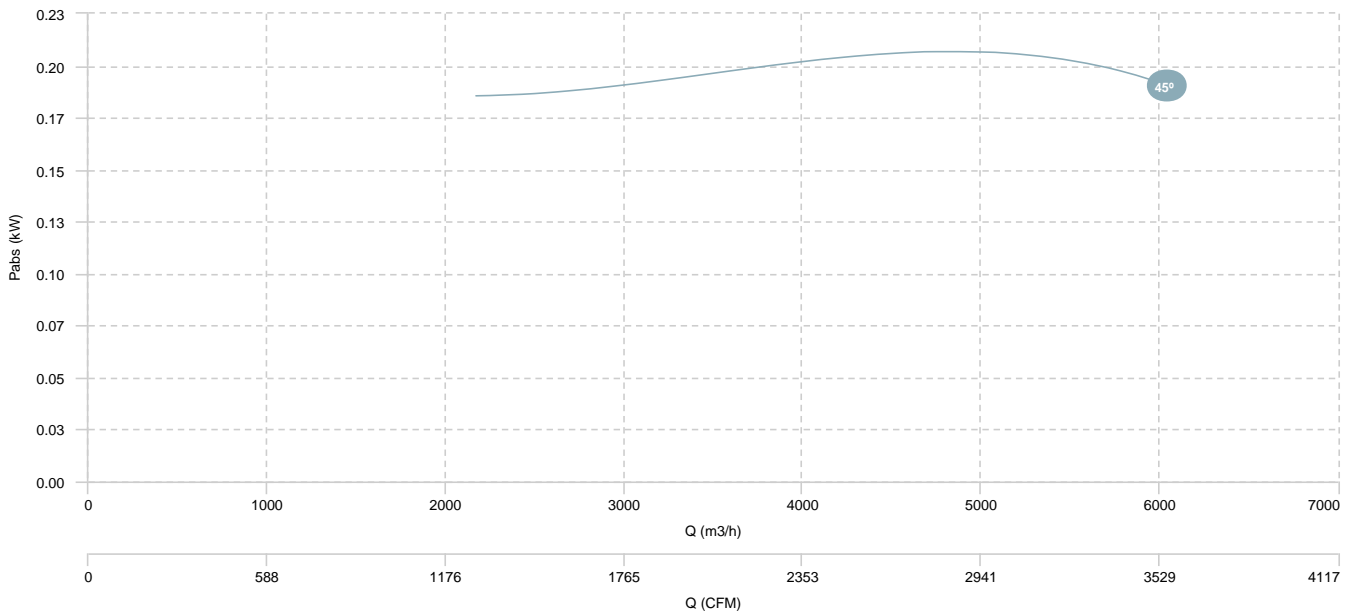

HC 56 M4 0,55kW (A2:6)

AIR FLOW - PRESSURE

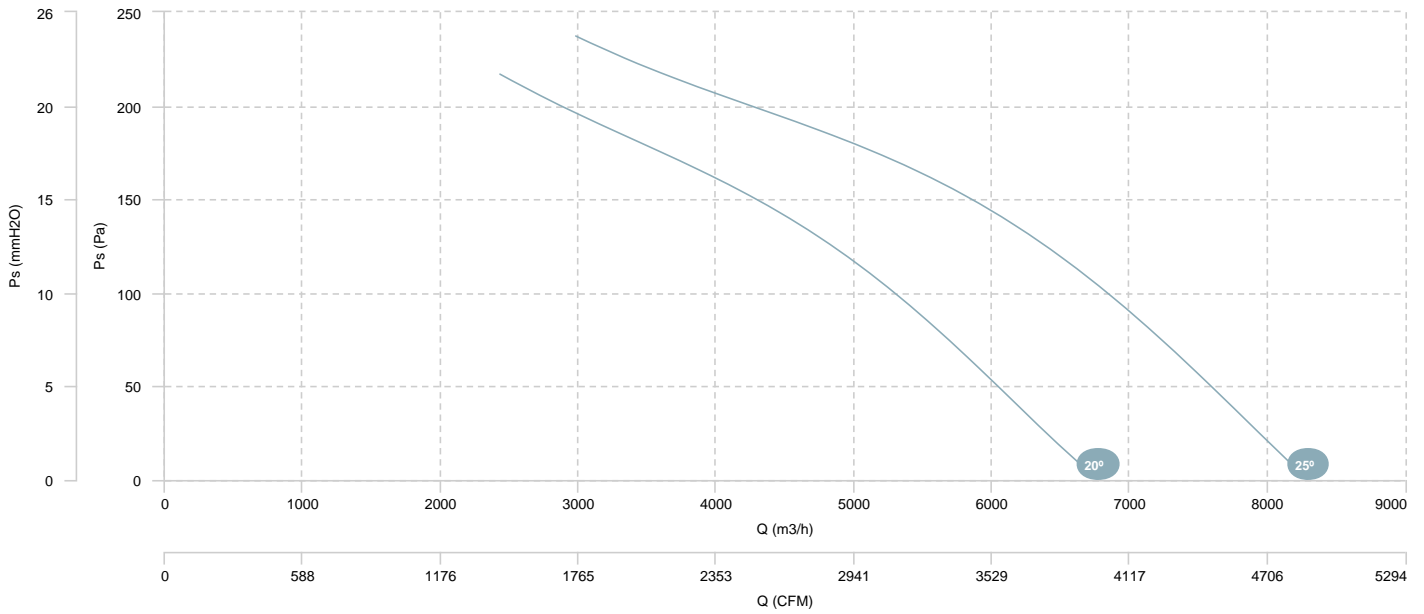

AIR FLOW - ABSORBED POWER

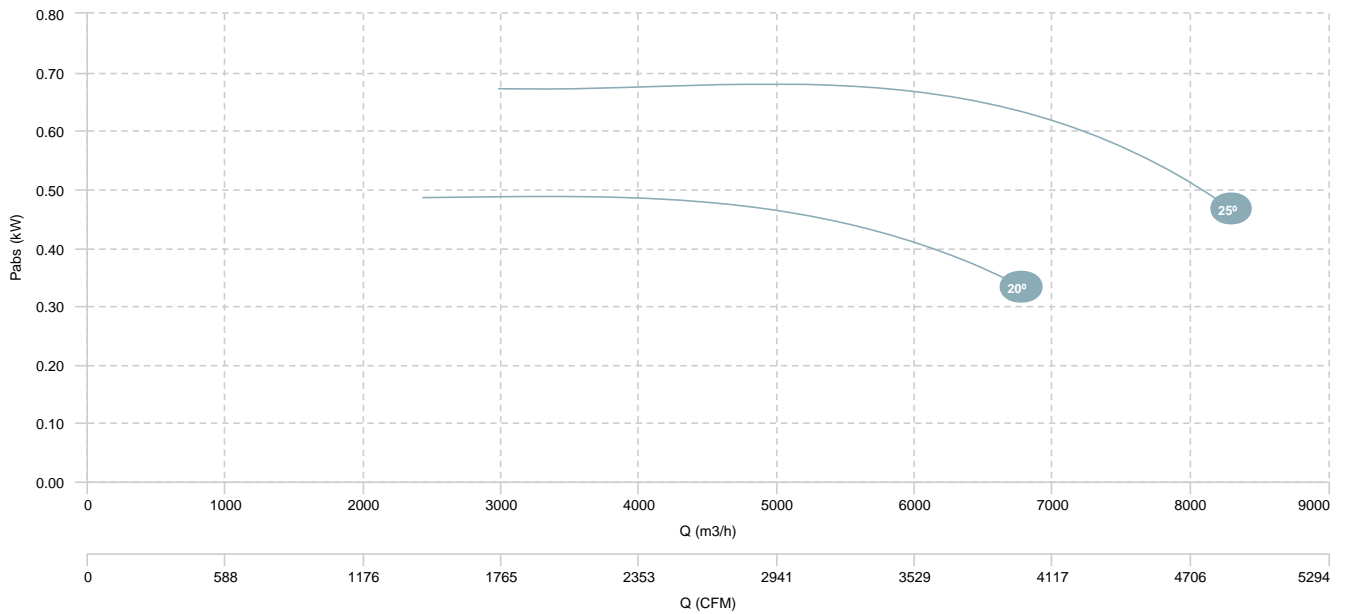

HC 56 M4 0,37kW (A5:6)

HC 56 M4 0,55kW (A5:6)

AIR FLOW - PRESSURE

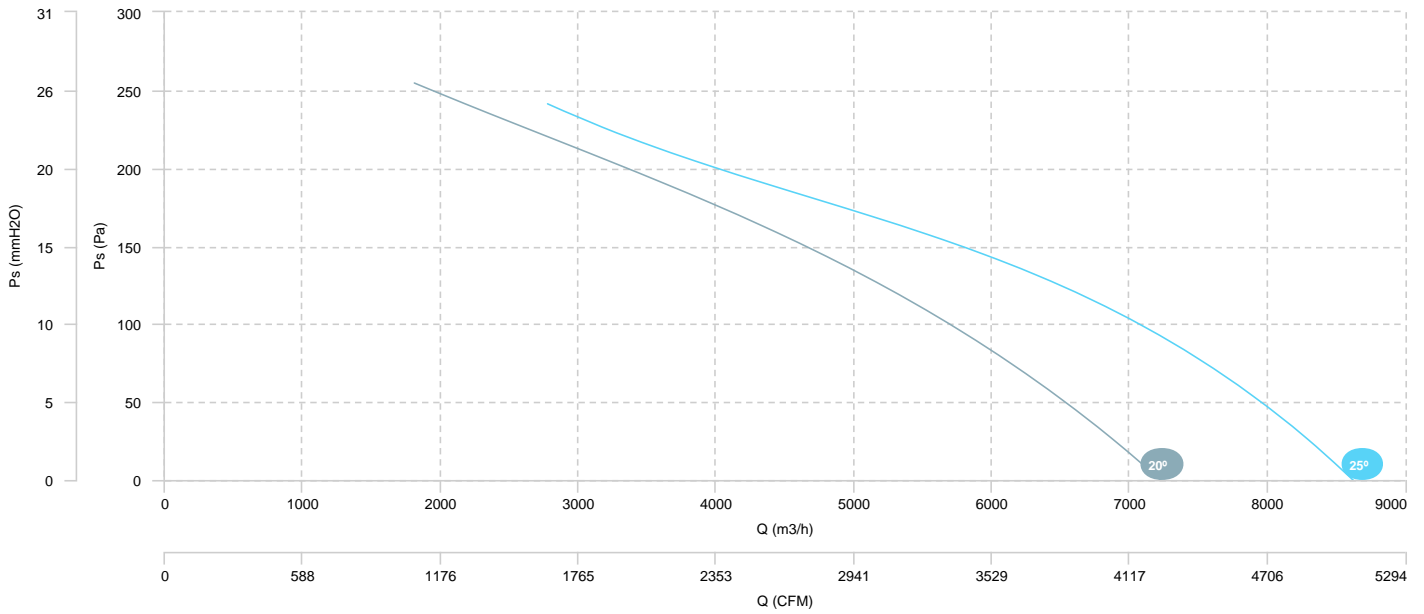

AIR FLOW - ABSORBED POWER

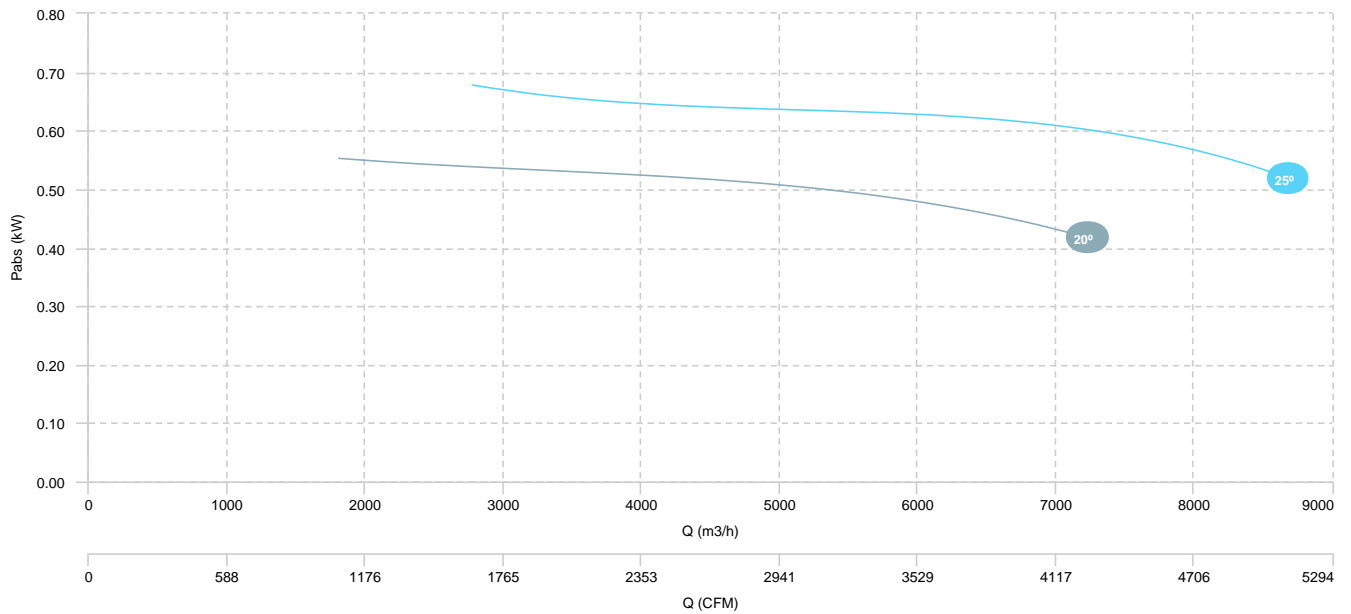

HC 56 M6 0,25kW (A2:6)

HC 56 M6 0,37kW (A2:6)

AIR FLOW - PRESSURE

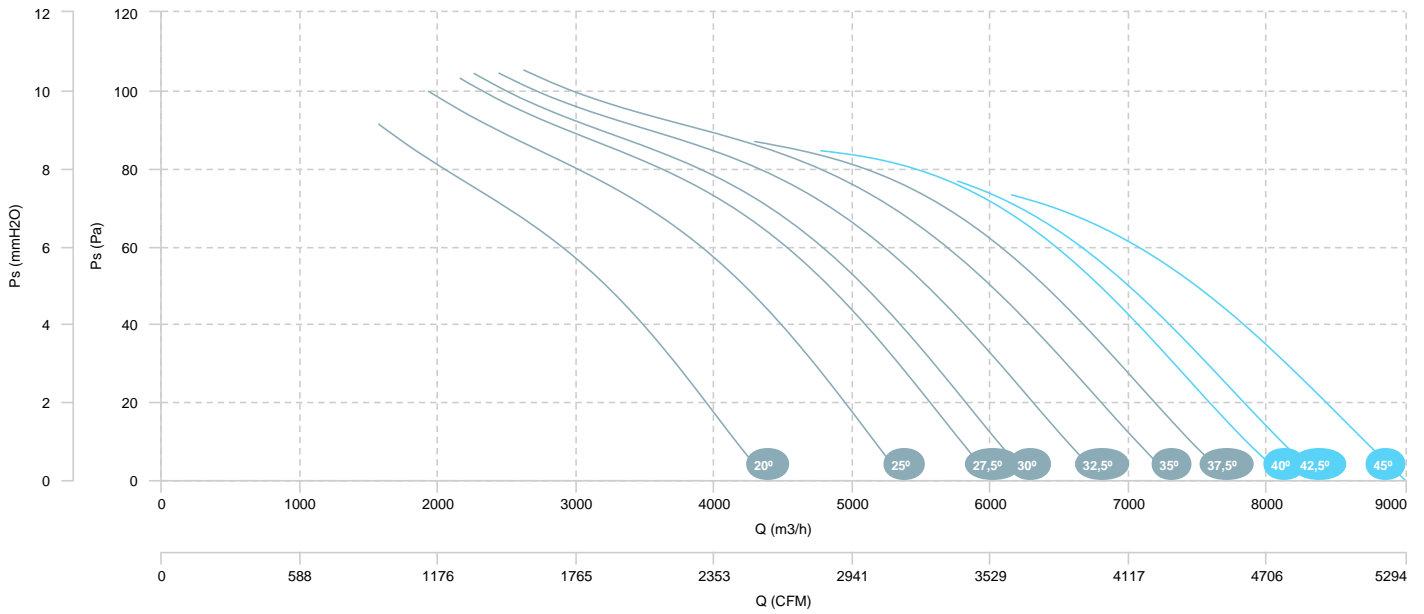

AIR FLOW - ABSORBED POWER

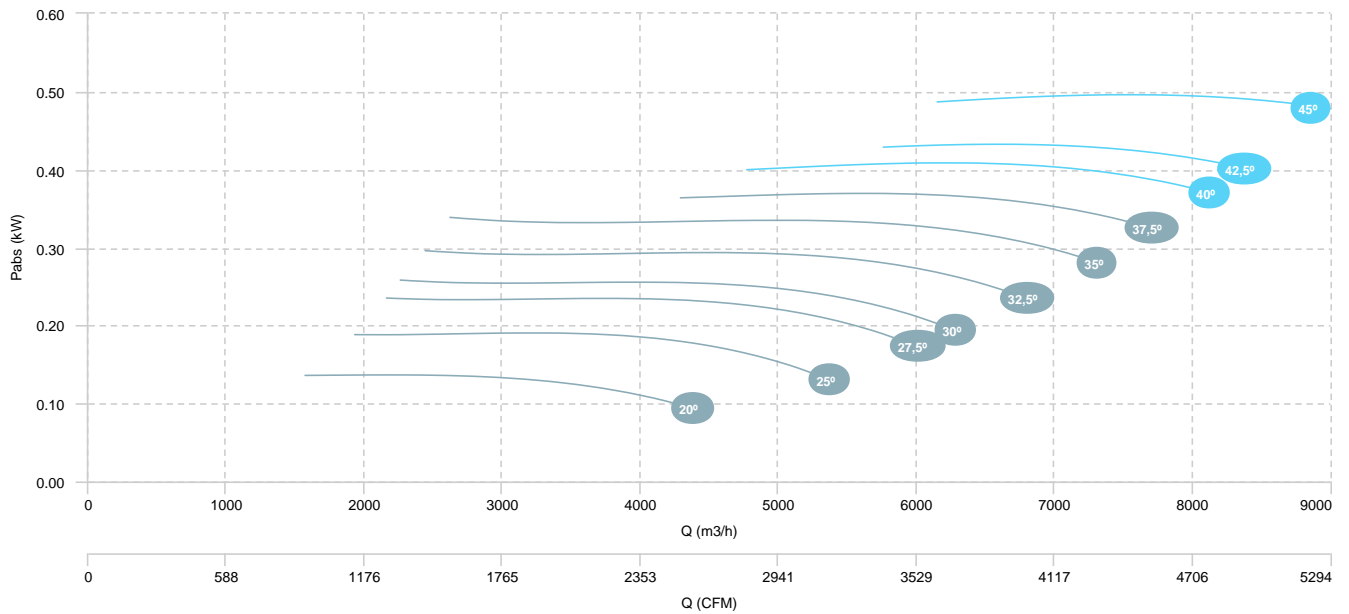

HC 56 M6 0,25kW (A5:6)

HC 56 M6 0,37kW (A5:6)

AIR FLOW - PRESSURE

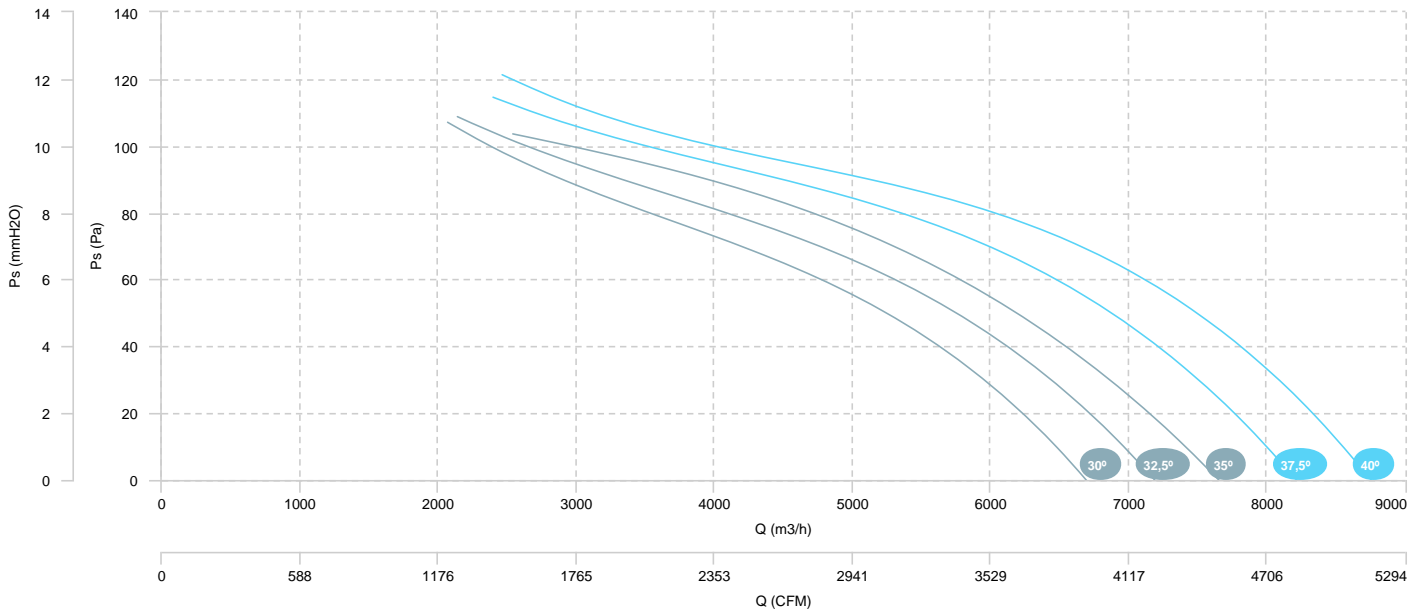

AIR FLOW - ABSORBED POWER

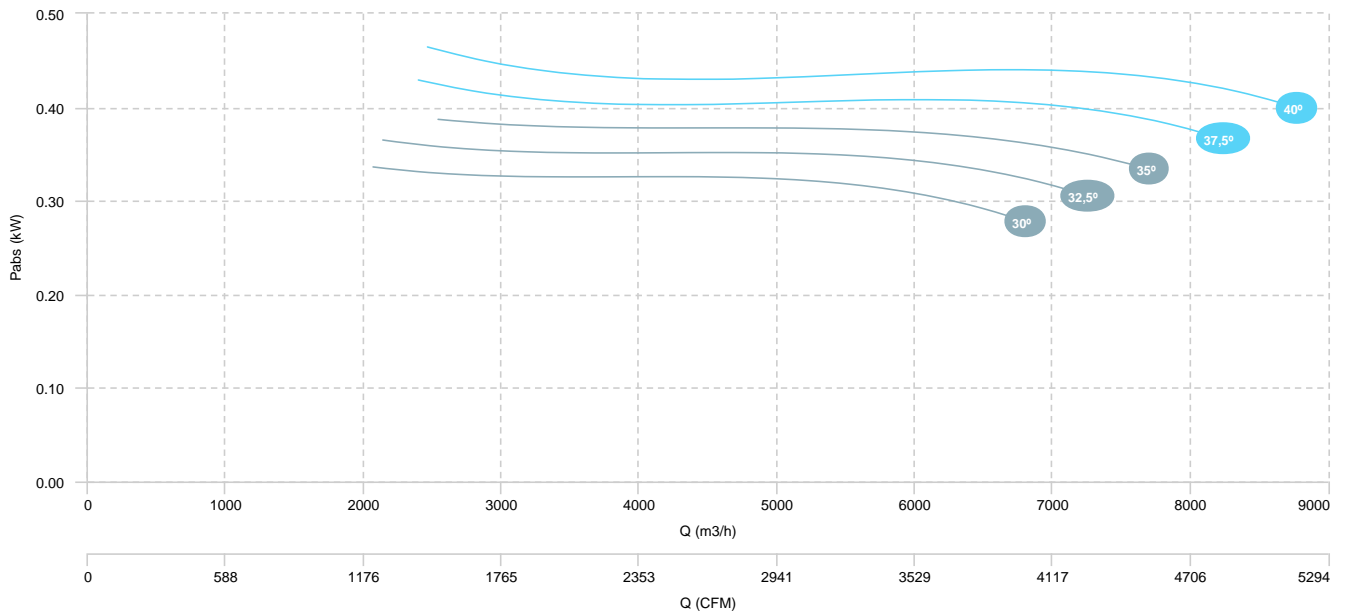

HC 63 M6 0,55kW (A2:9)

AIR FLOW - PRESSURE

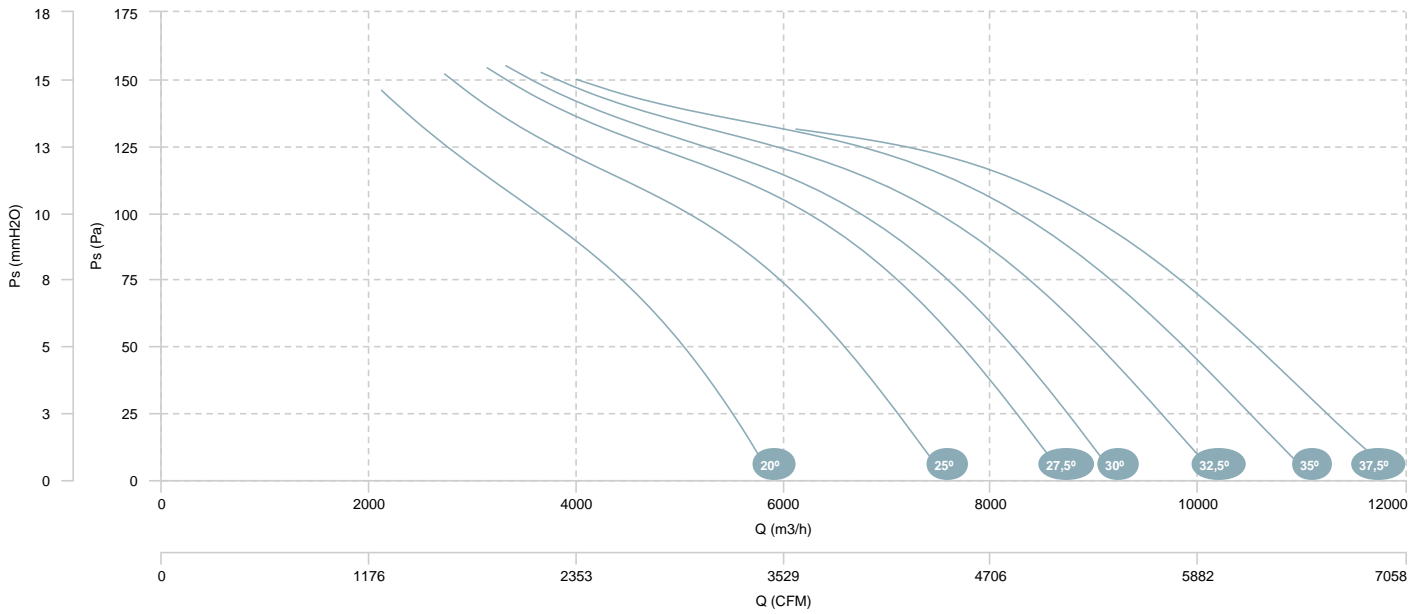

AIR FLOW - ABSORBED POWER

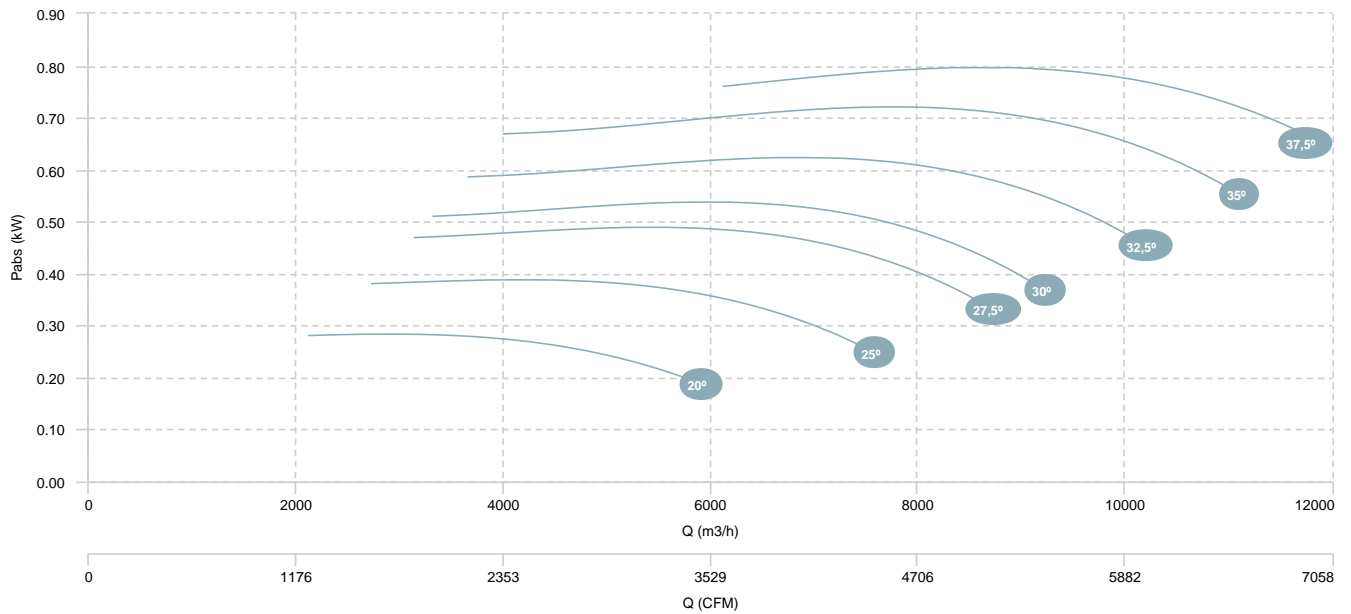

HC 63 M6 0,37kW (A5:6)

HC 63 M6 0,55kW (A5:6)

AIR FLOW - PRESSURE

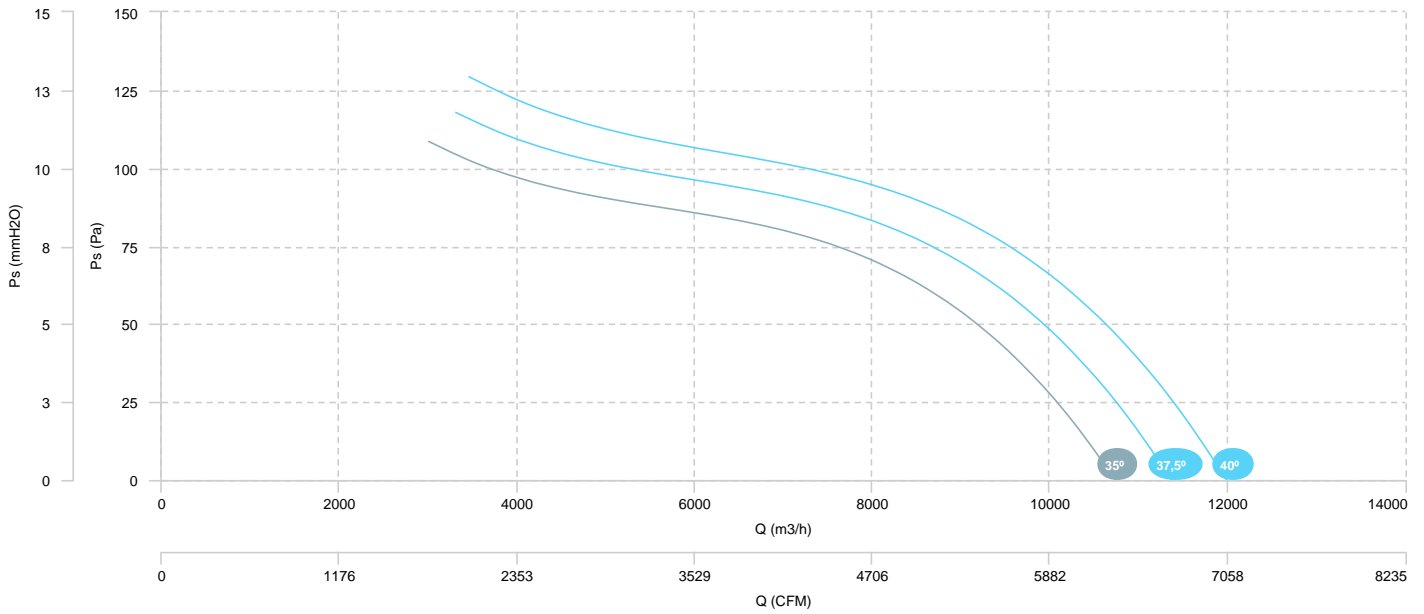

AIR FLOW - ABSORBED POWER

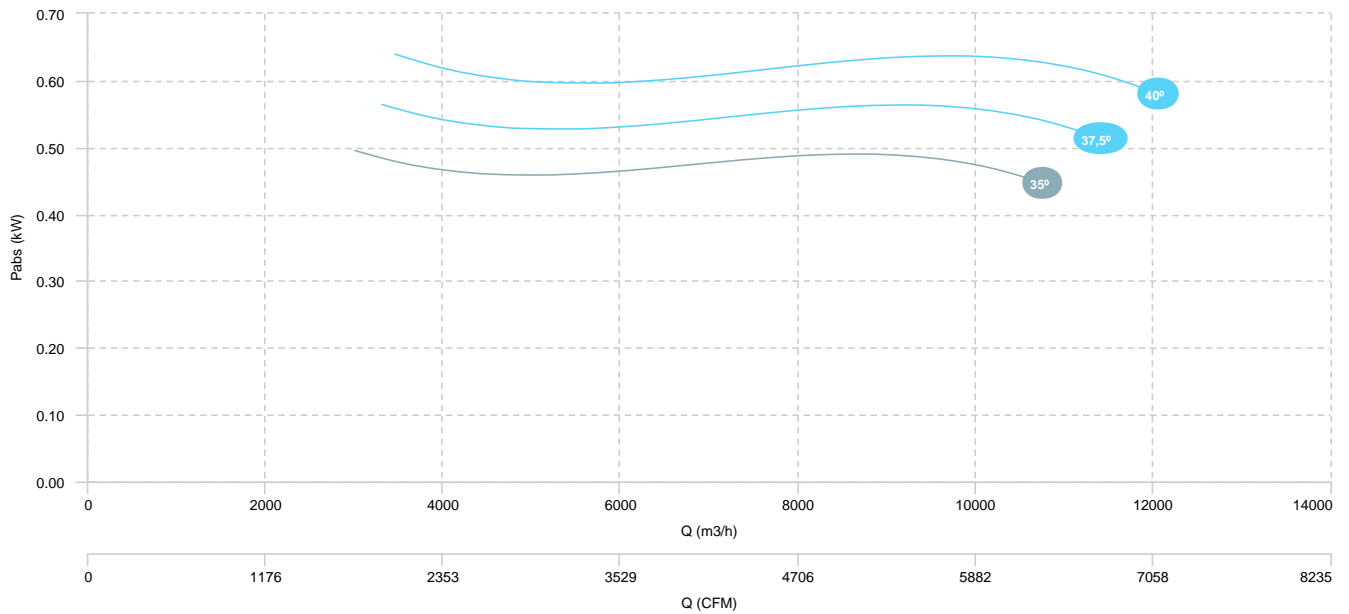

HC 71 M6 0,55kW (A2:9)

AIR FLOW - PRESSURE

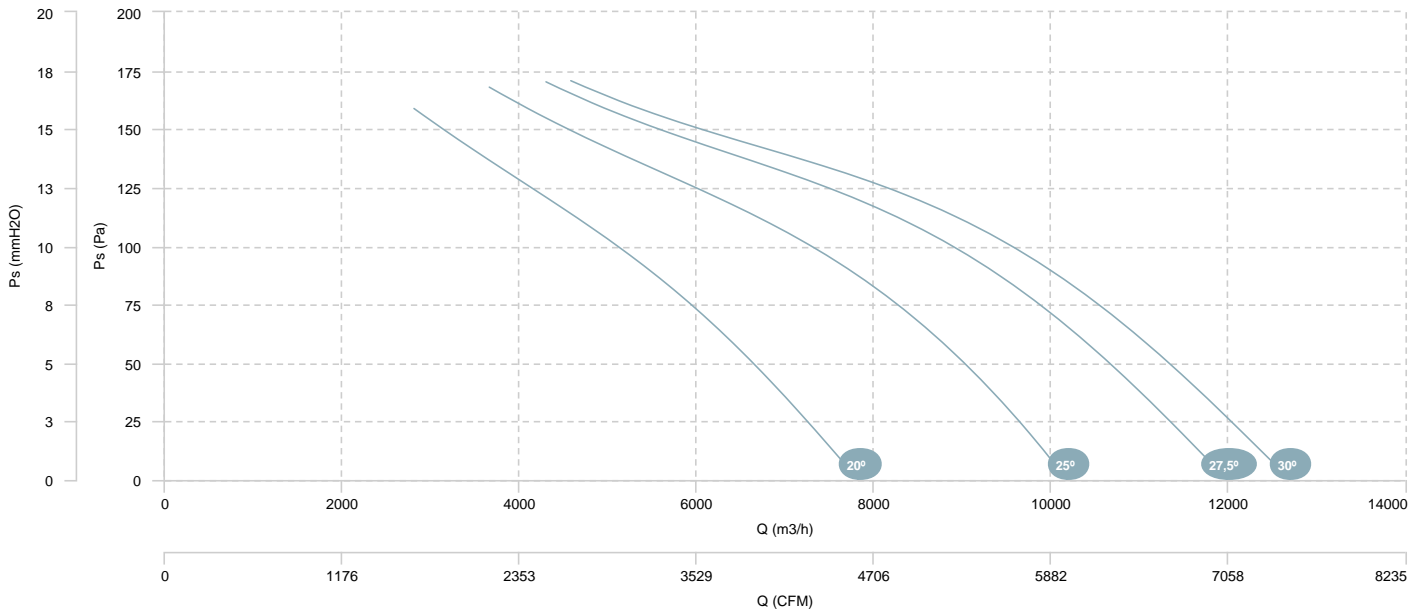

AIR FLOW - ABSORBED POWER

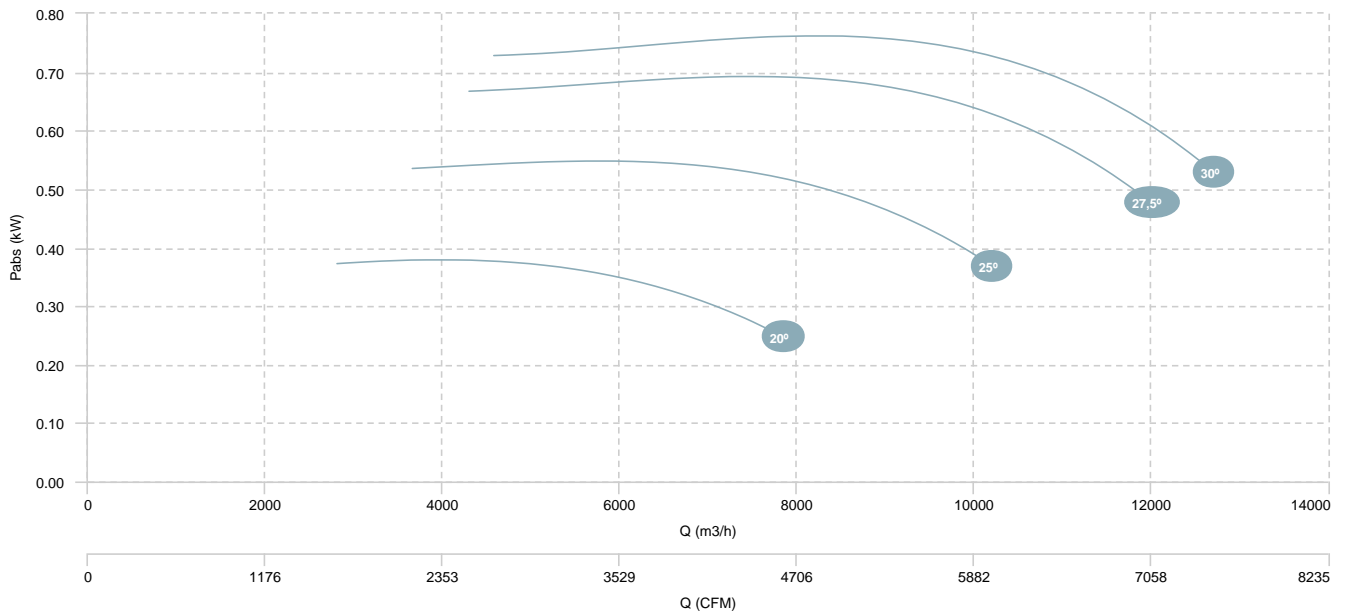

HC 71 M6 0,55kW (A2:6)

AIR FLOW - PRESSURE

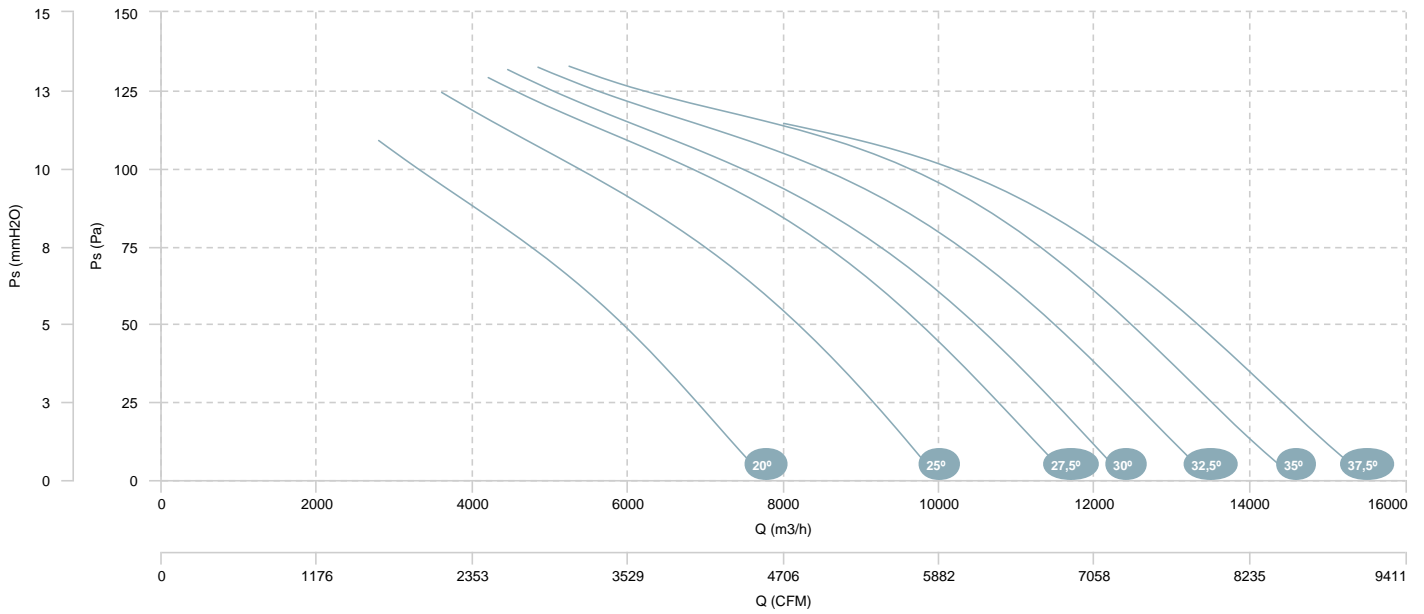

AIR FLOW - ABSORBED POWER

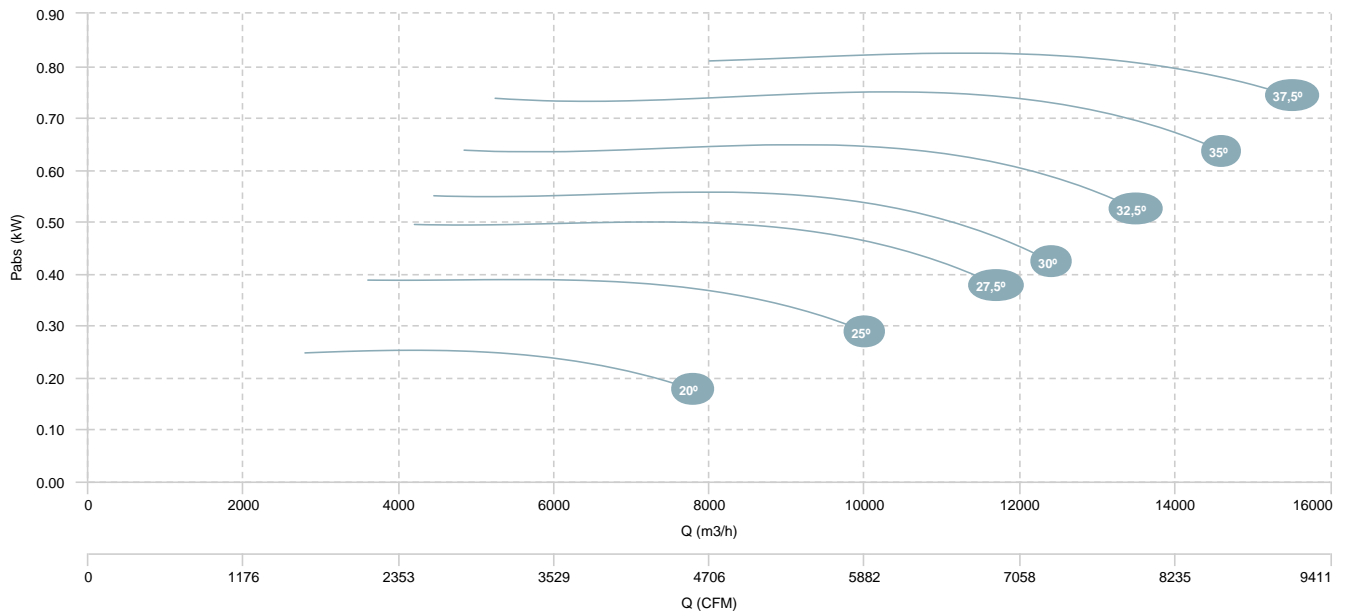

HC 35 T2 0,55kW (A0:6)

HC 35 T2 1,1kW (A0:6)

AIR FLOW - PRESSURE

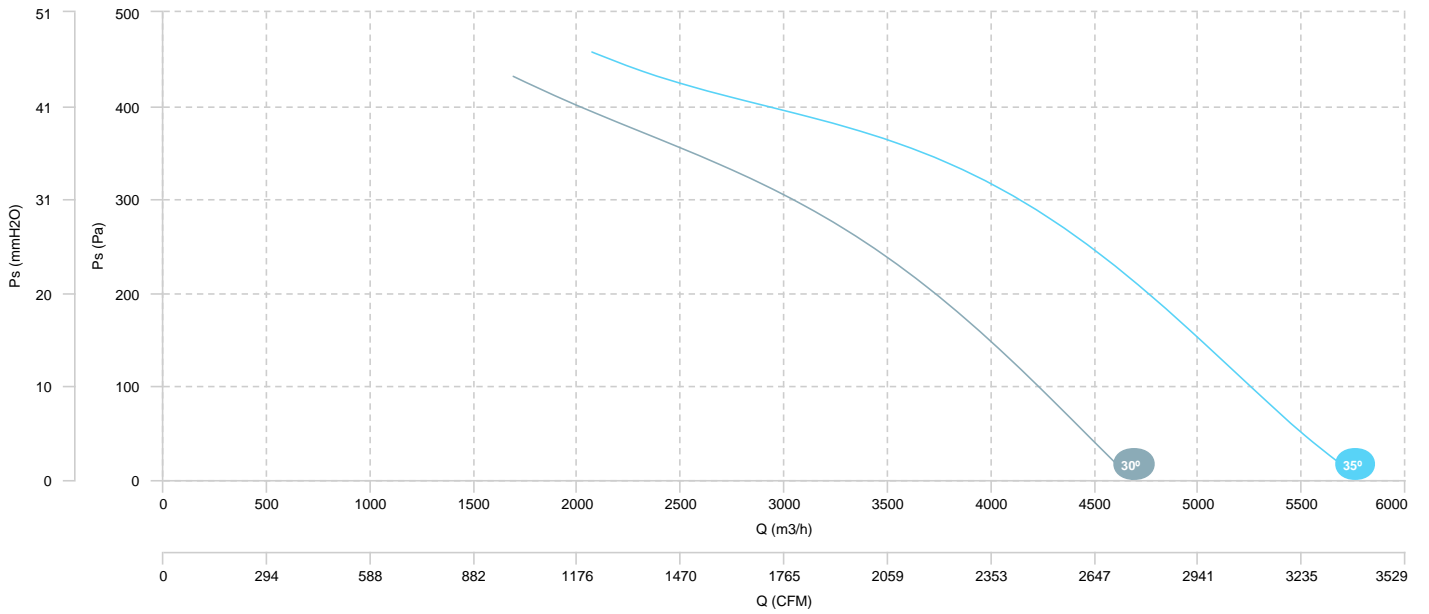

AIR FLOW - ABSORBED POWER

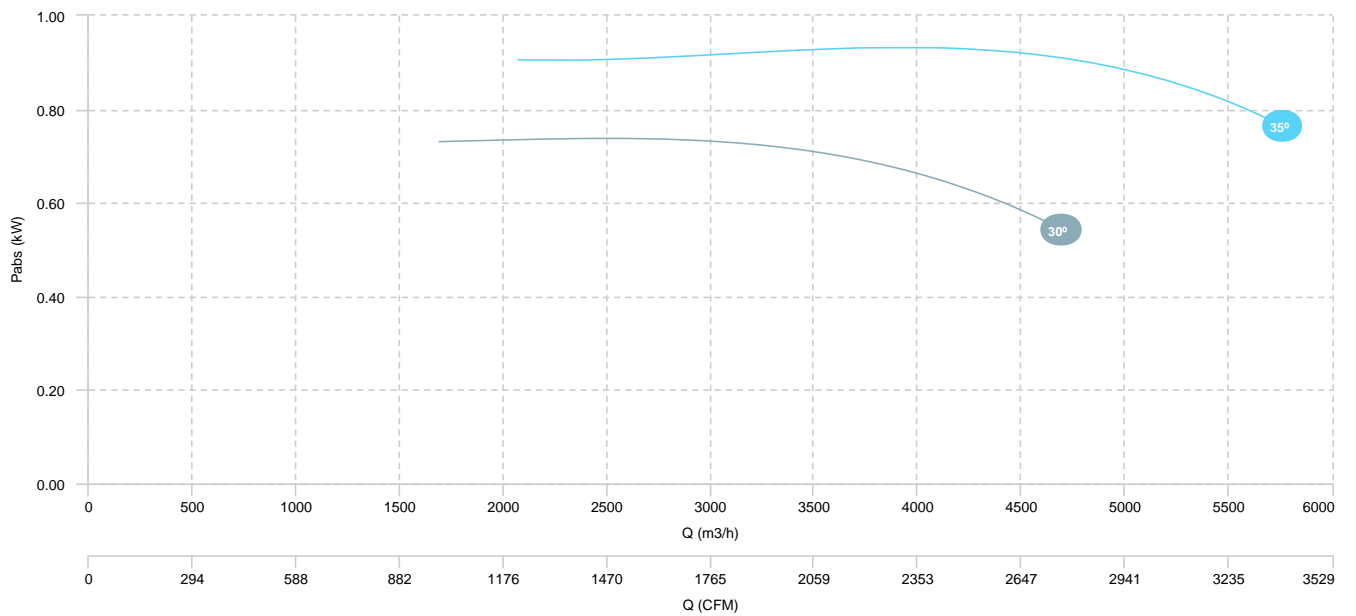

HC 35 T4 0,12kW (A0:6)

AIR FLOW - PRESSURE

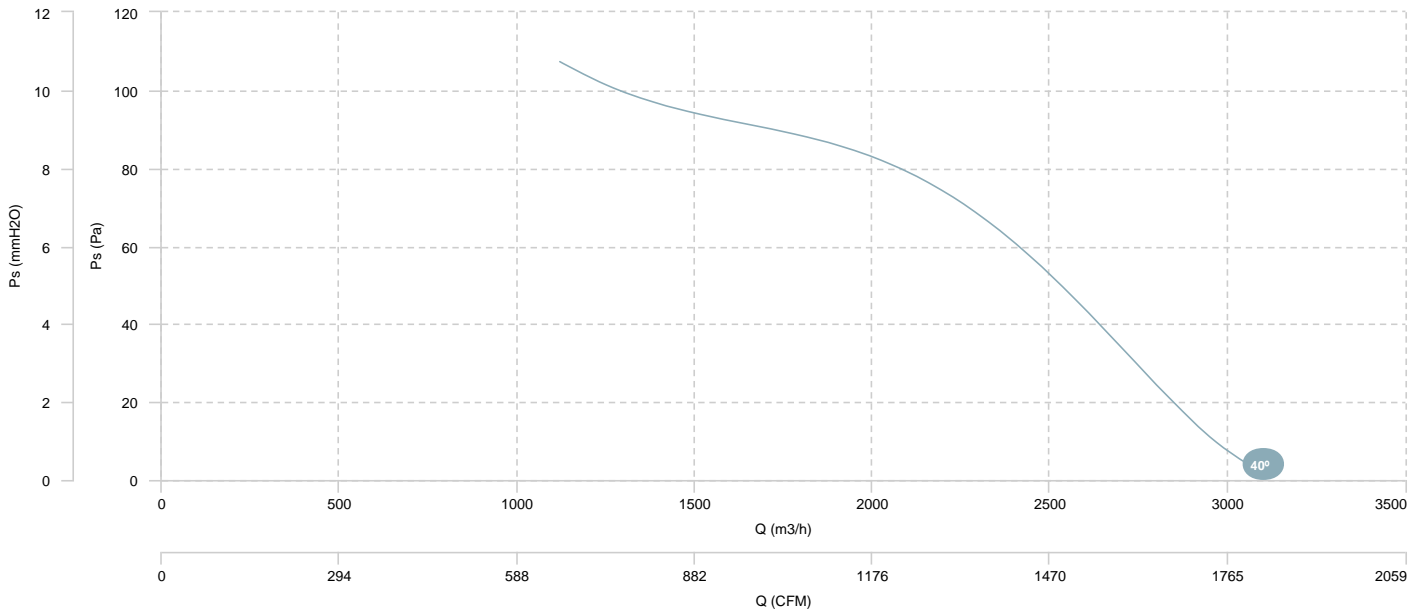

AIR FLOW - ABSORBED POWER

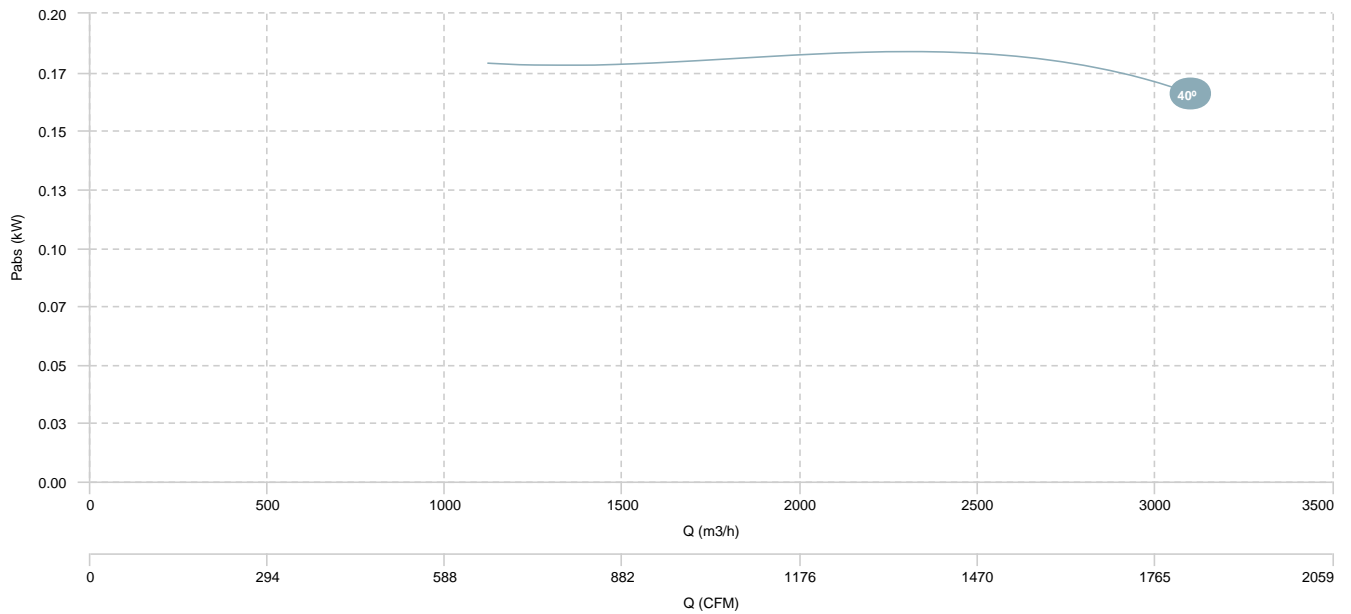

HC 40 T2 1,1kW (A0:6)

AIR FLOW - PRESSURE

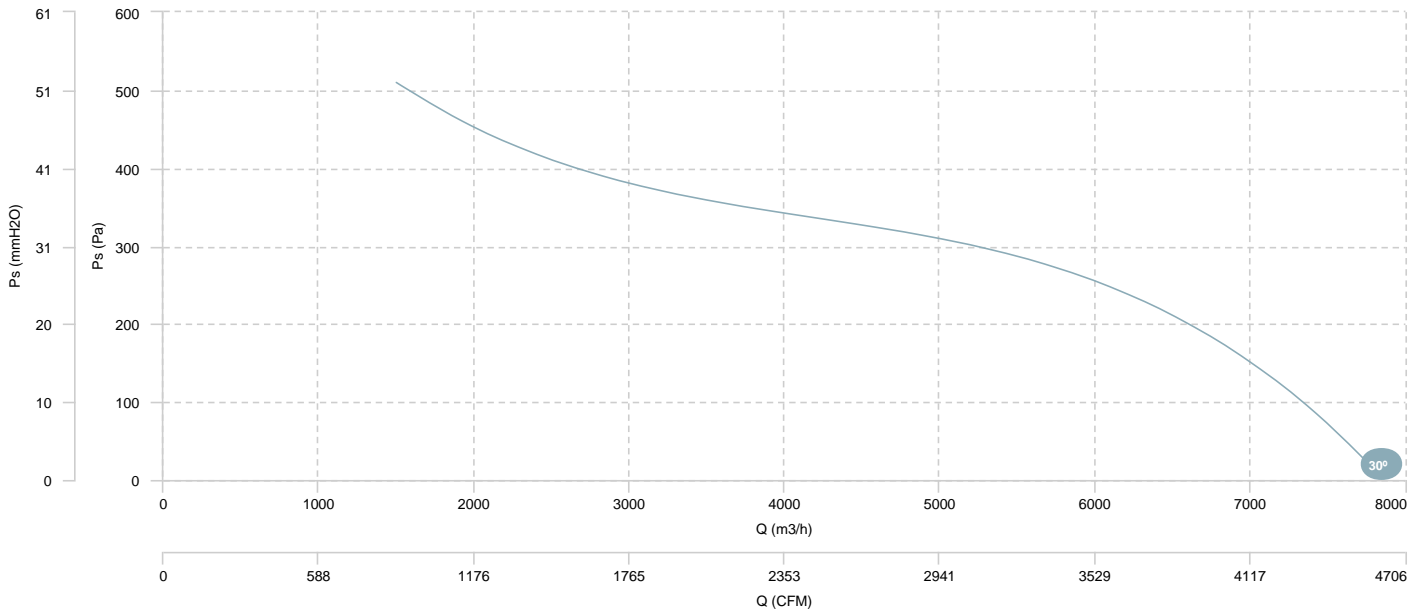

AIR FLOW - ABSORBED POWER

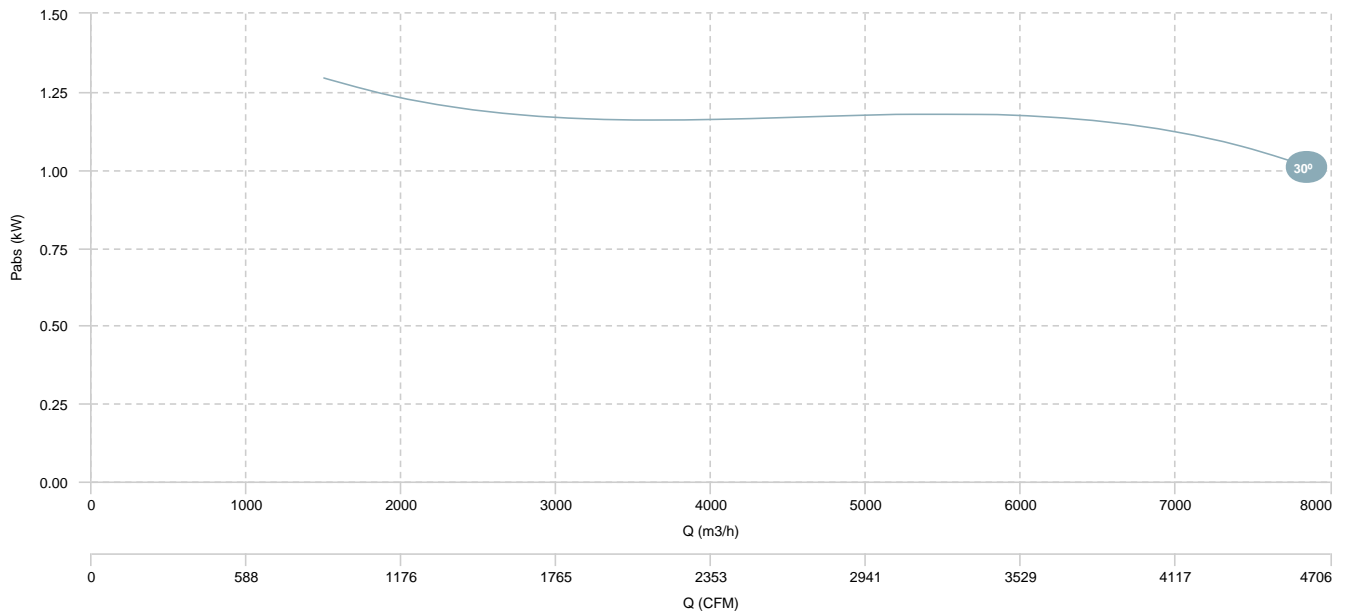

HC 40 T4 0,25kW (A0:6)

AIR FLOW - PRESSURE

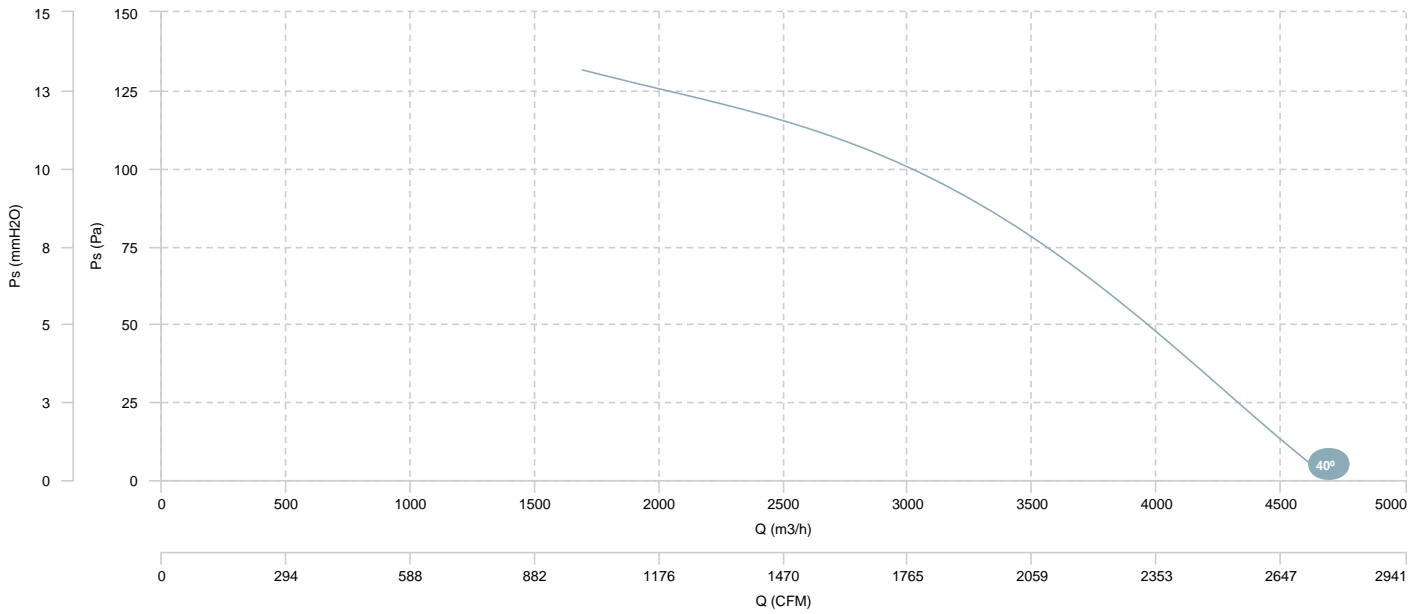

AIR FLOW - ABSORBED POWER

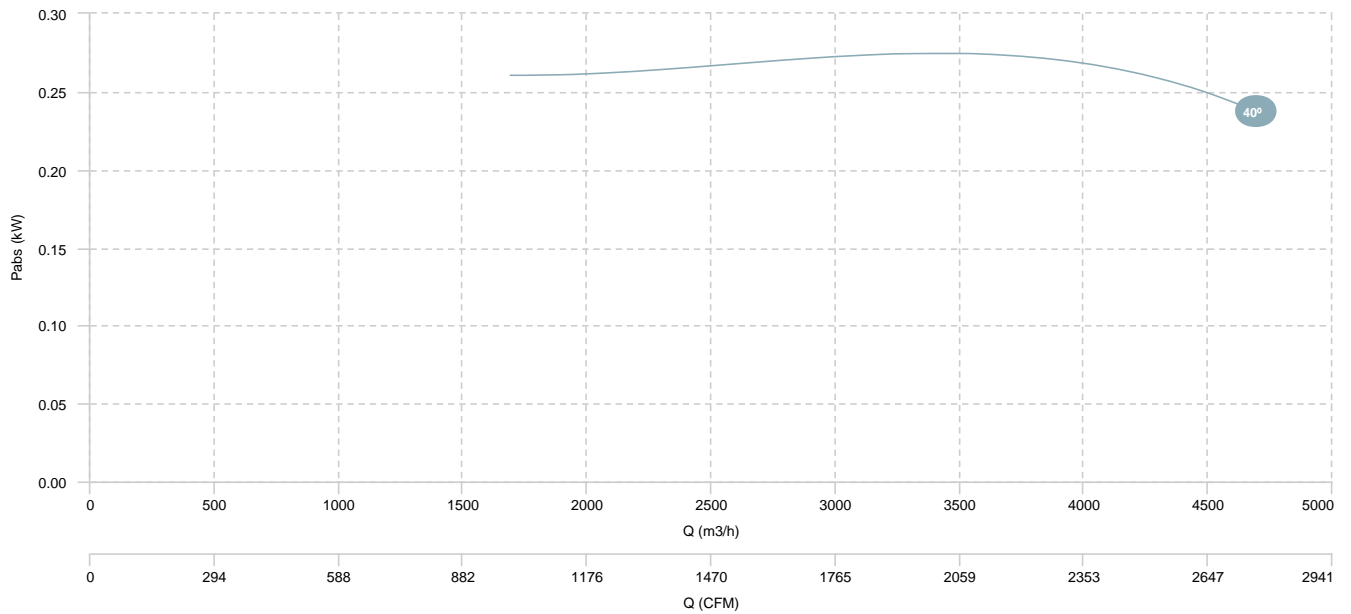

HC 40 T6 0,12kW (A0:6)

AIR FLOW - PRESSURE

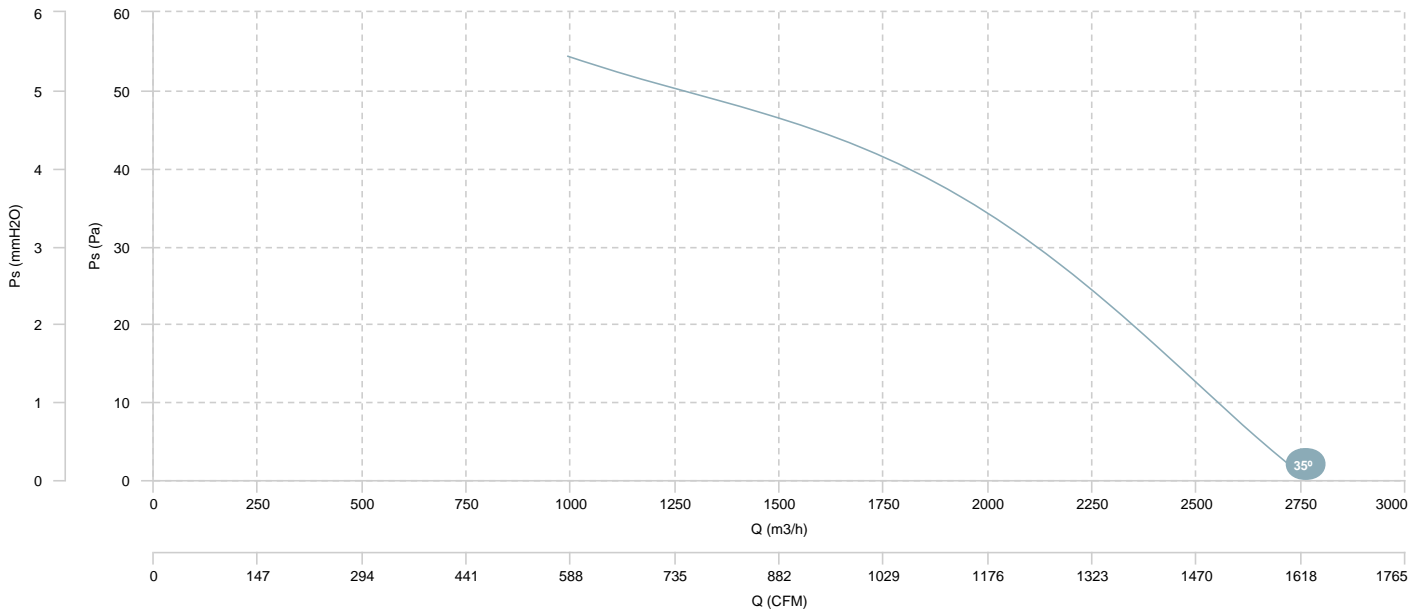

AIR FLOW - ABSORBED POWER

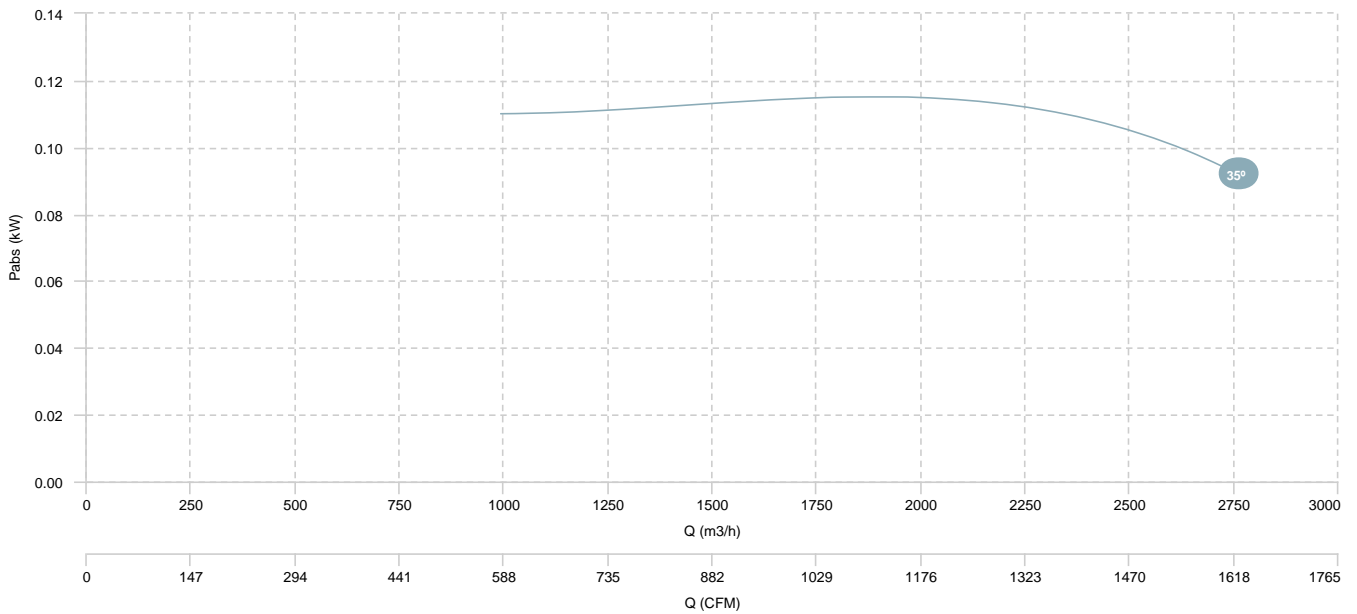

HC 45 T2 1,5kW (A0:6)

HC 45 T2 2,2kW (A0:6)

AIR FLOW - PRESSURE

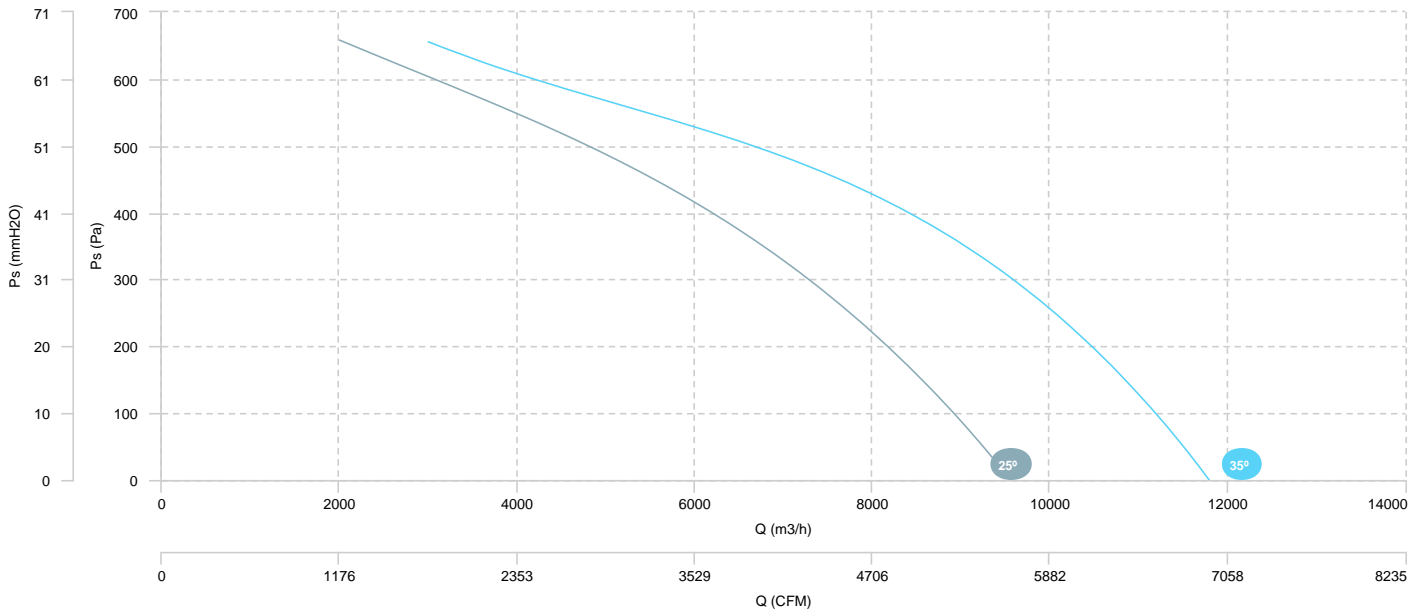

AIR FLOW - ABSORBED POWER

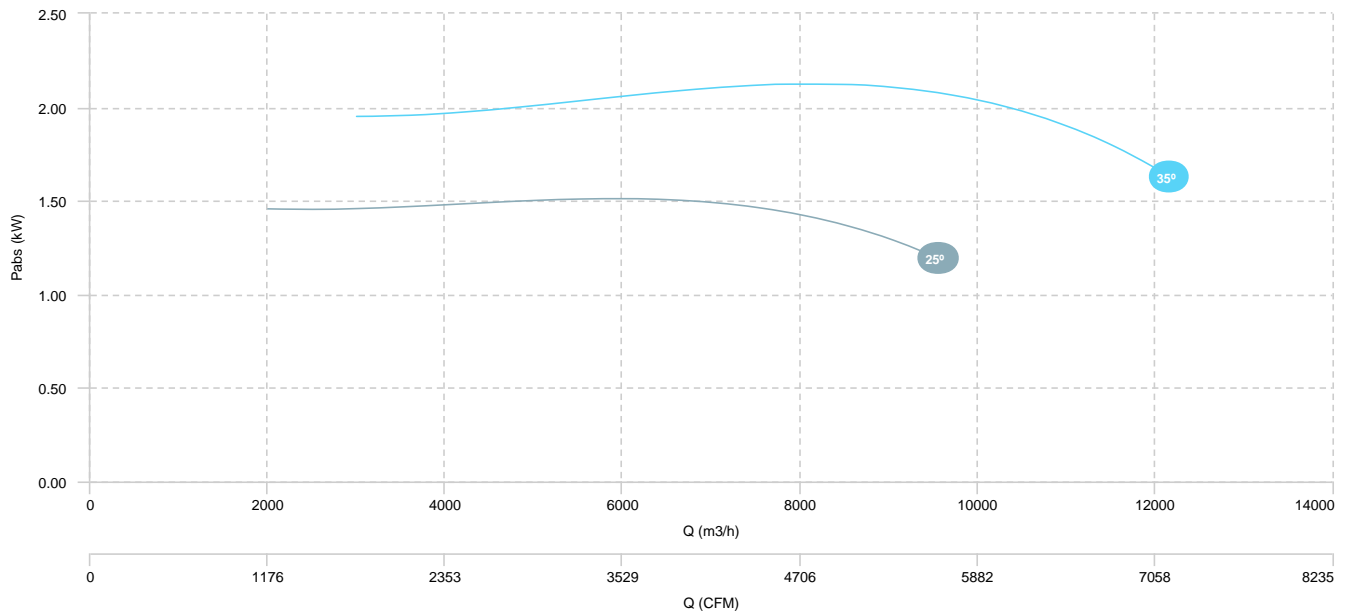

HC 45 T4 0,55kW (A0:6)

AIR FLOW - PRESSURE

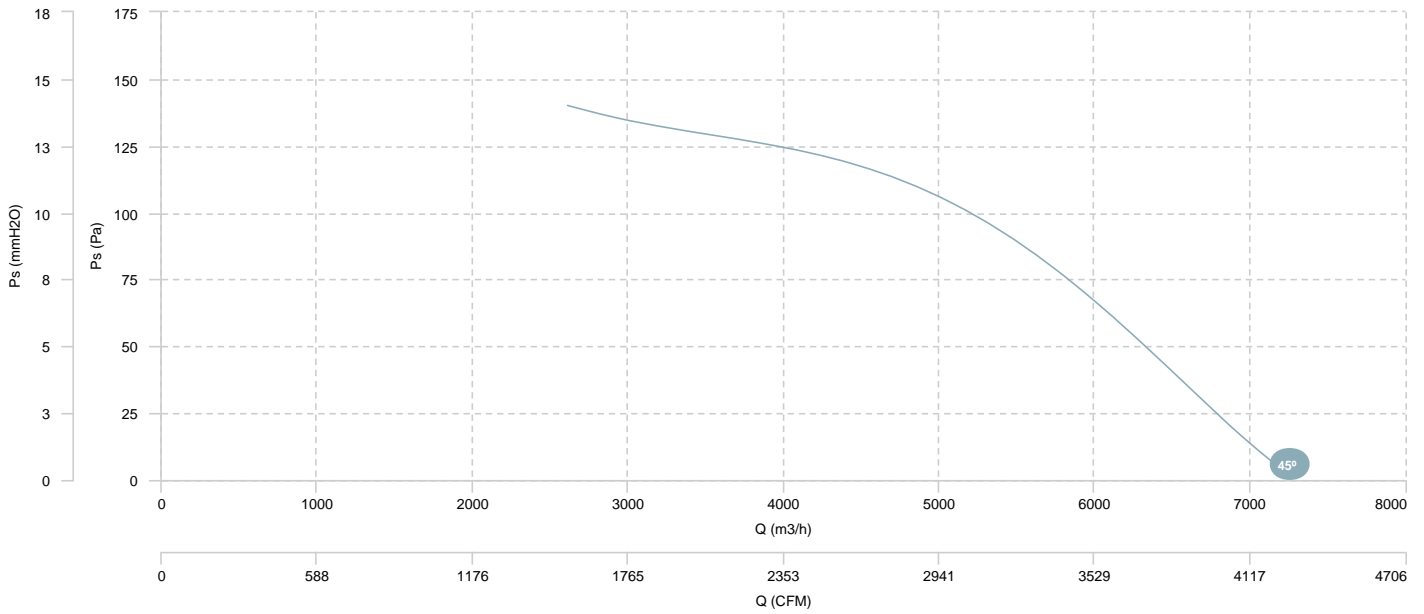

AIR FLOW - ABSORBED POWER

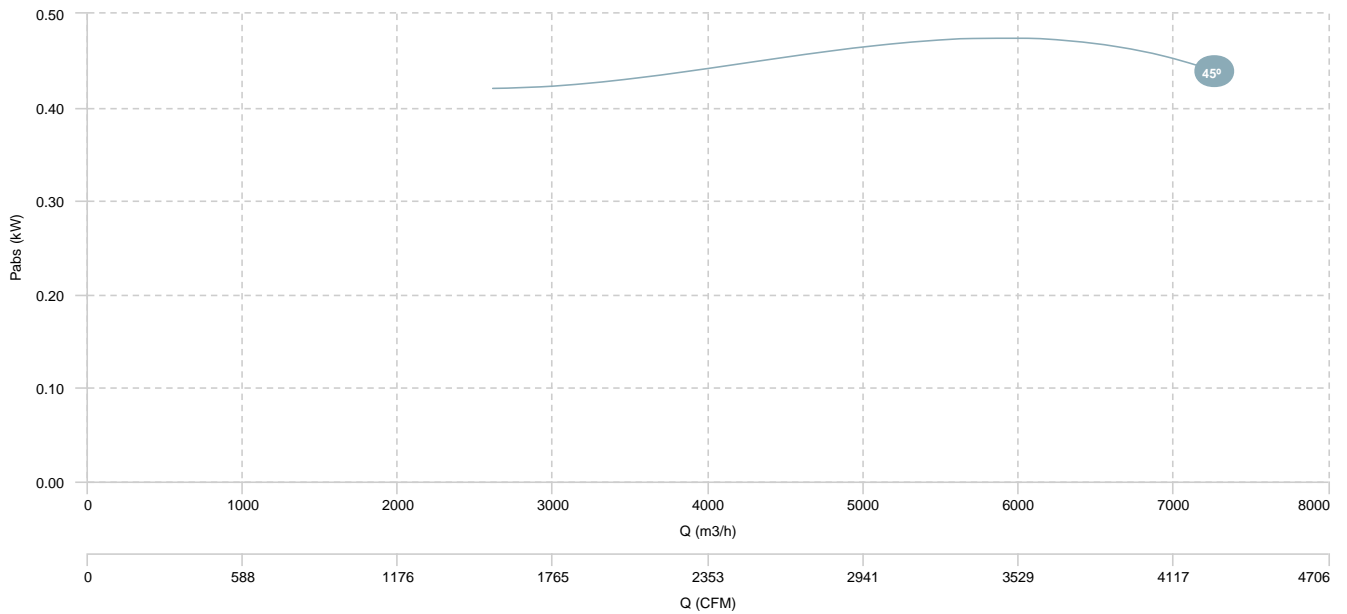

HC 45 T6 0,13kW (A0:6)

AIR FLOW - PRESSURE

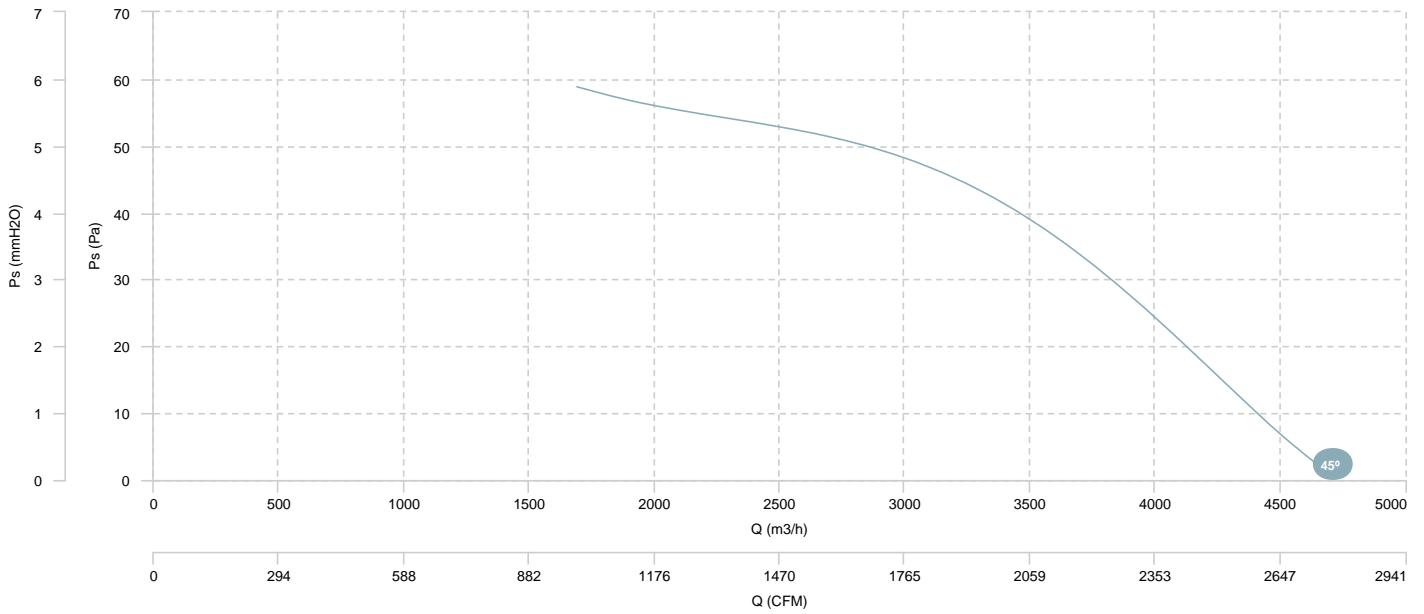

AIR FLOW - ABSORBED POWER

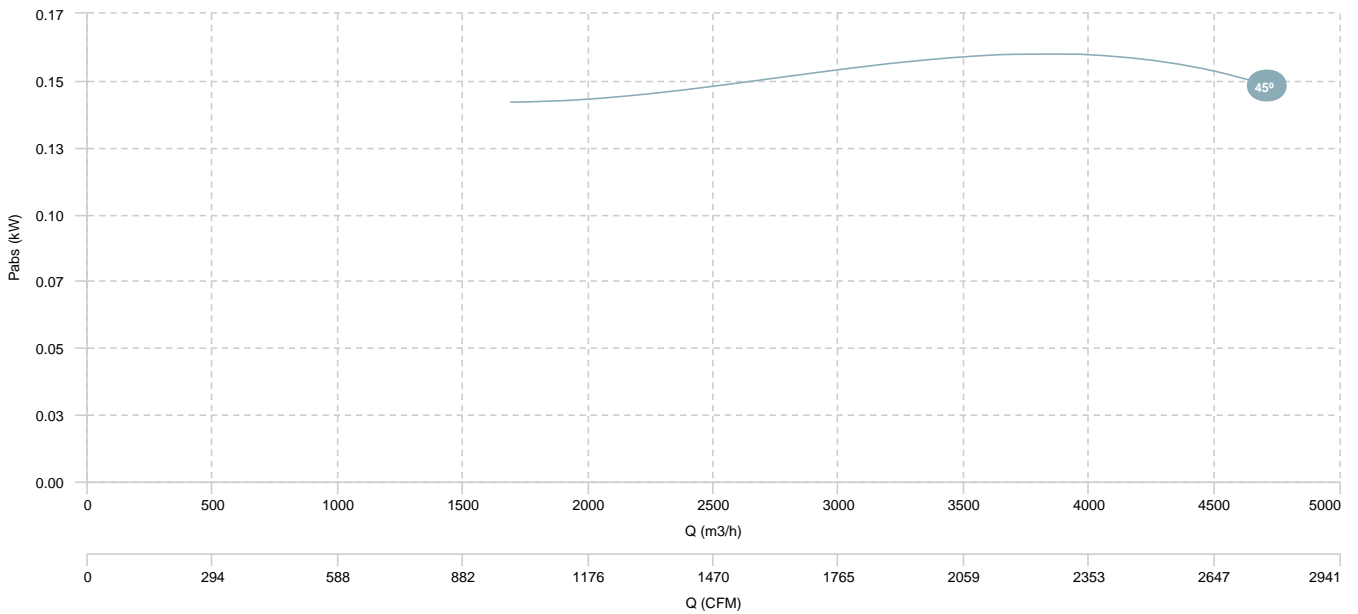

HC 45 T4/T6 0,55/0,18kW (A0:6)

AIR FLOW - PRESSURE (4 POLES)

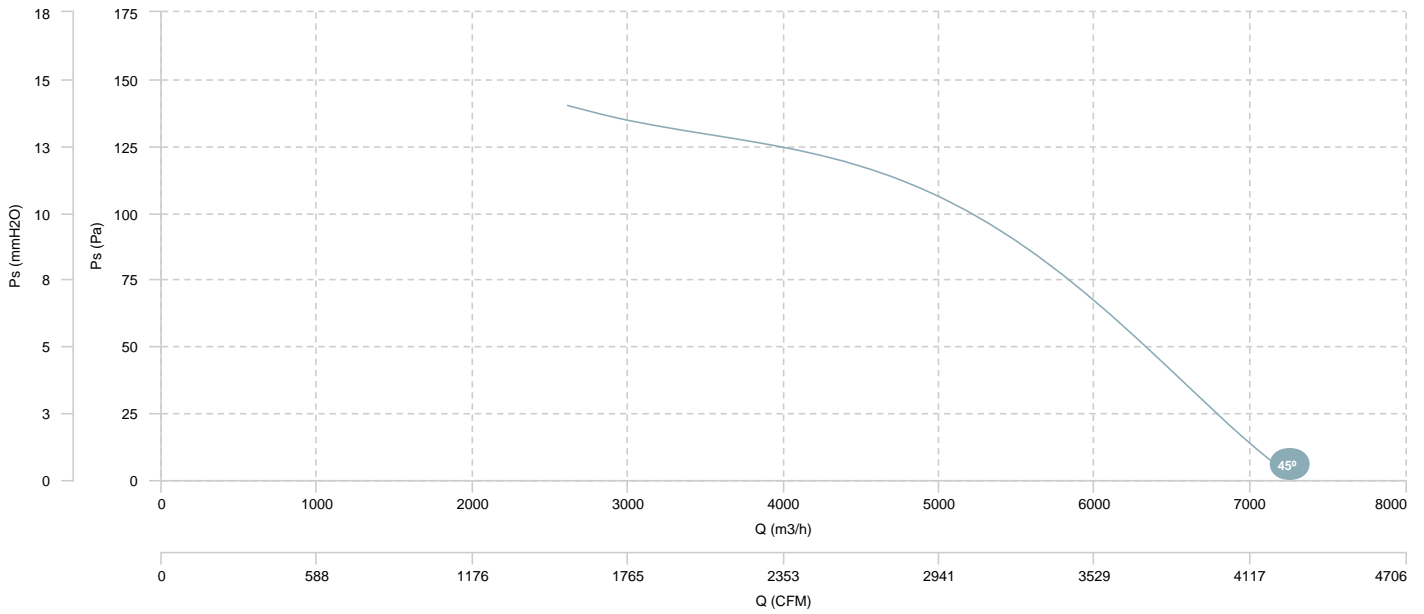

AIR FLOW - ABSORBED POWER (4 POLES)

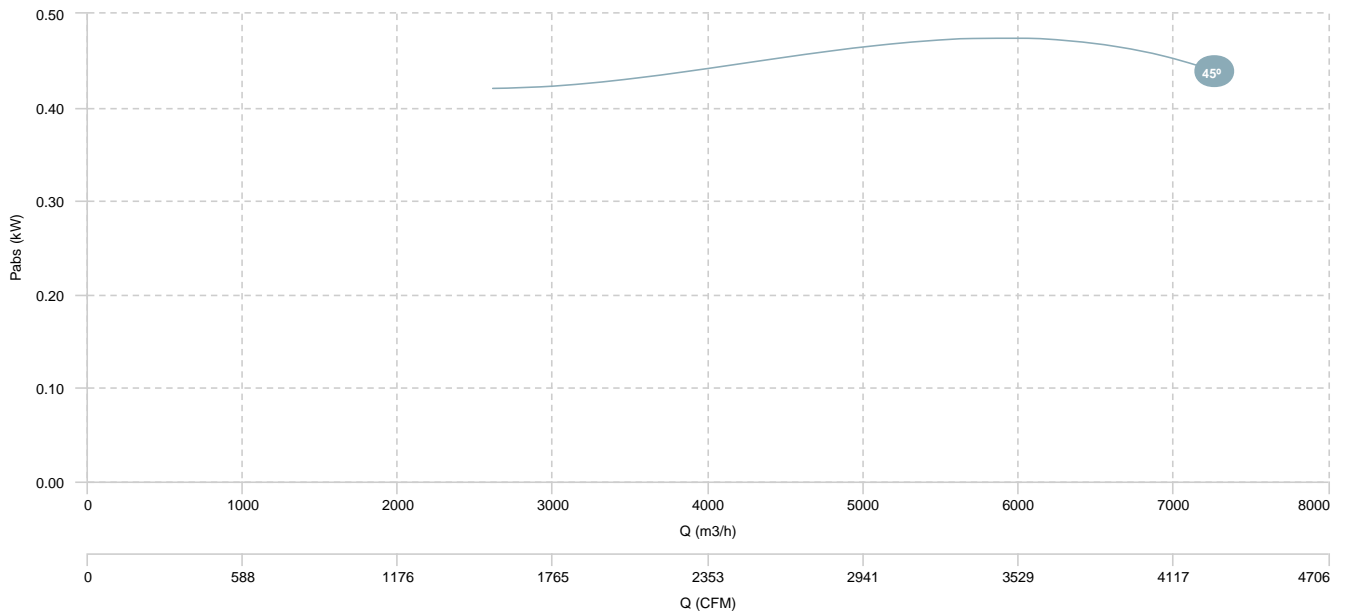

HC 45 T4/T6 0,55/0,18kW (A0:6)

AIR FLOW - PRESSURE (6 POLES)

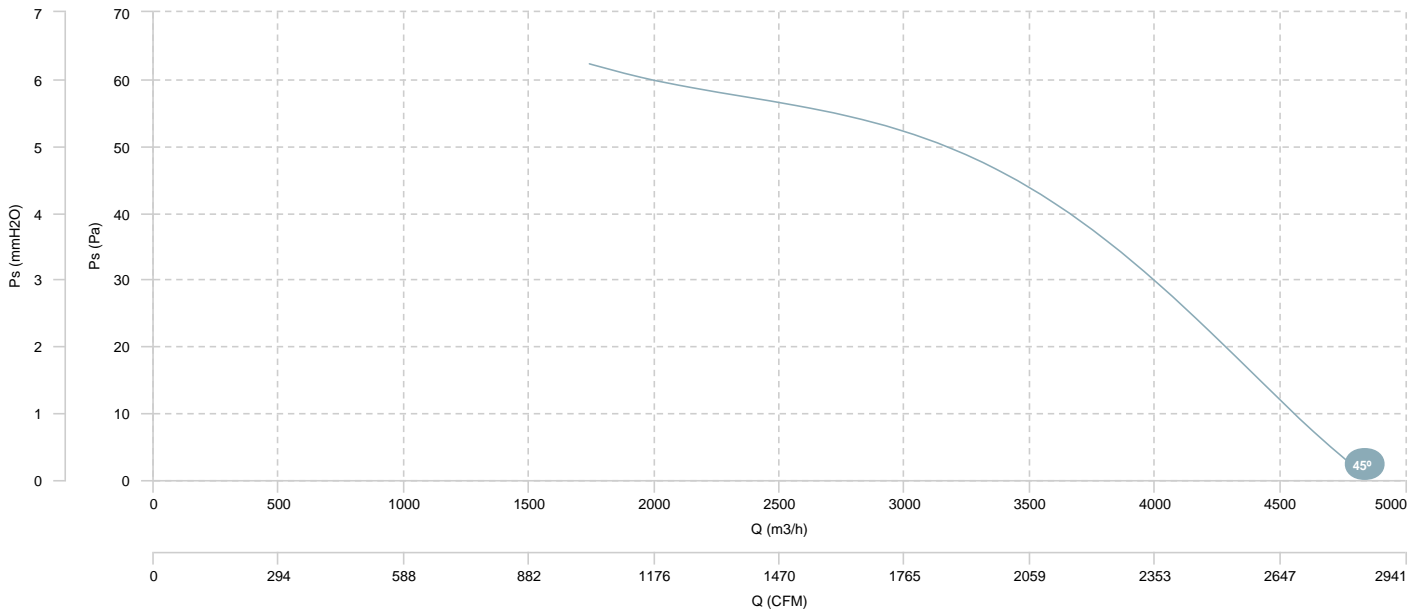

HC 45 T4/T8 0,33/0,04kW (A0:6)

AIR FLOW - PRESSURE (4 POLES)

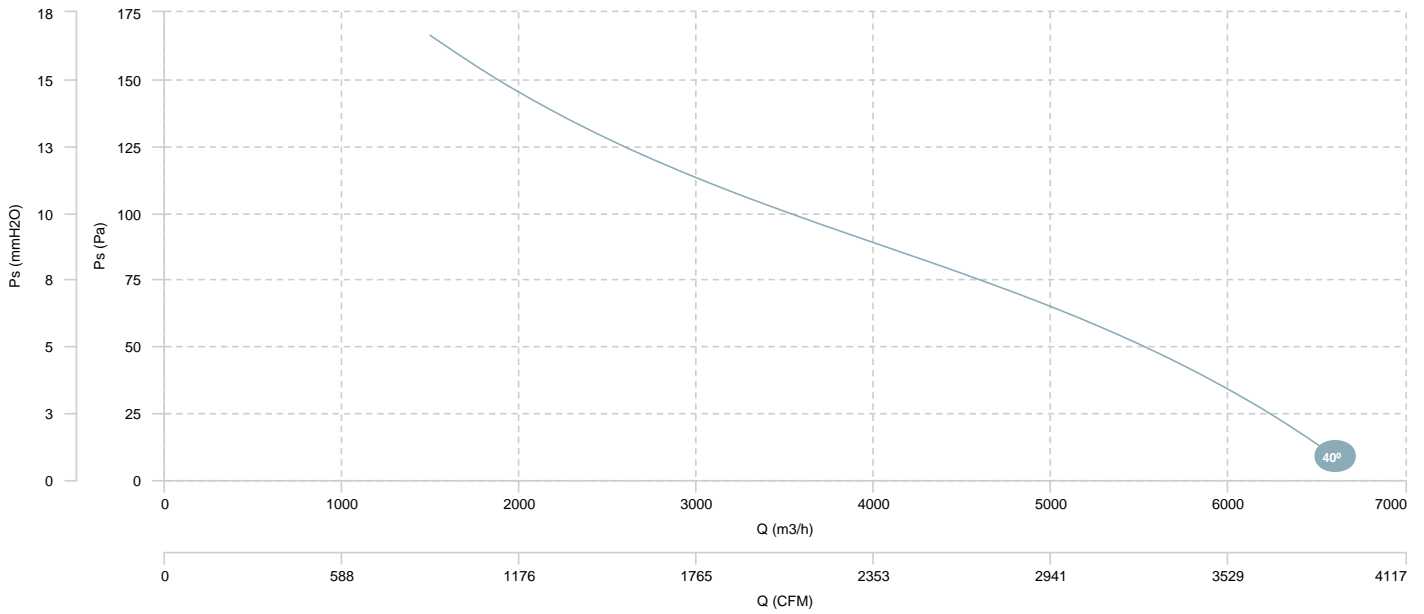

AIR FLOW - ABSORBED POWER (4 POLES)

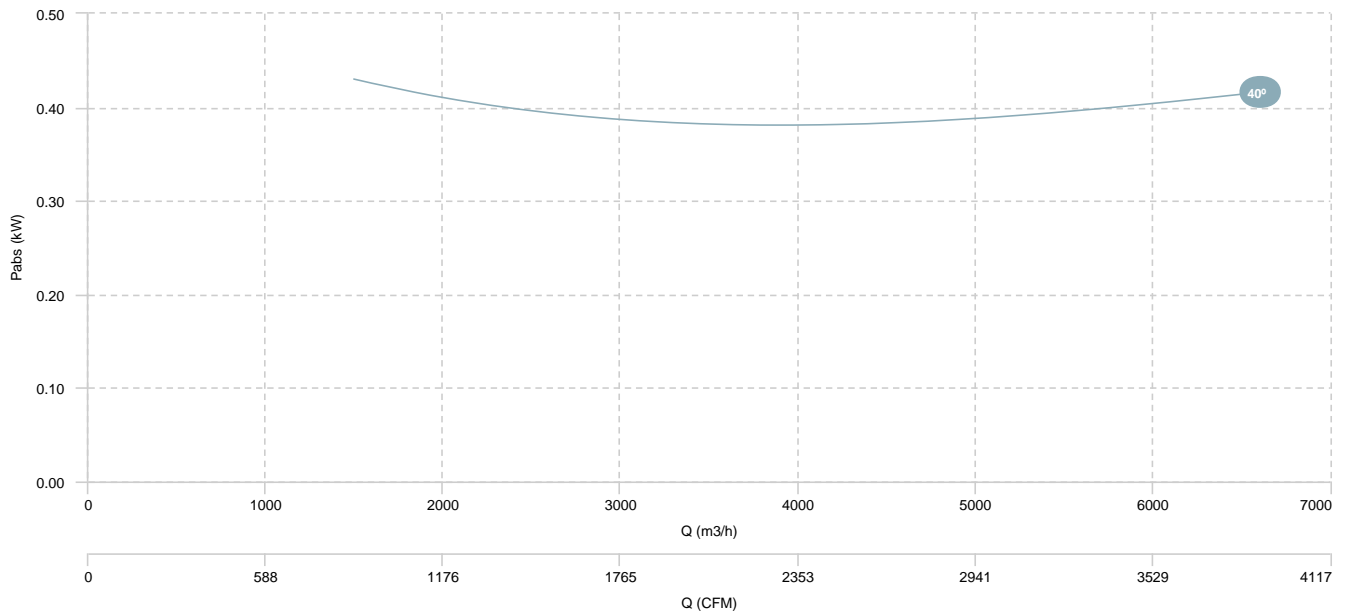

HC 45 T4/T8 0,33/0,04kW (A0:6)

AIR FLOW - PRESSURE (8 POLES)

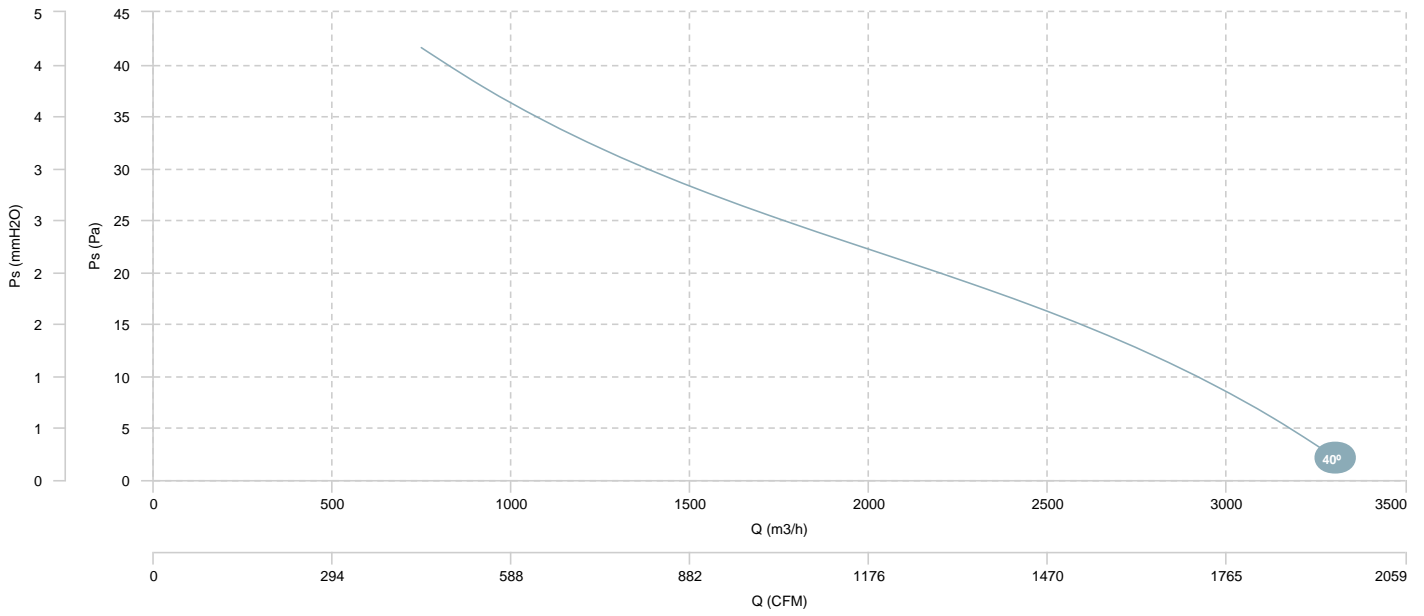

HC 50 T4 0,55kW (A0:6)

AIR FLOW - PRESSURE

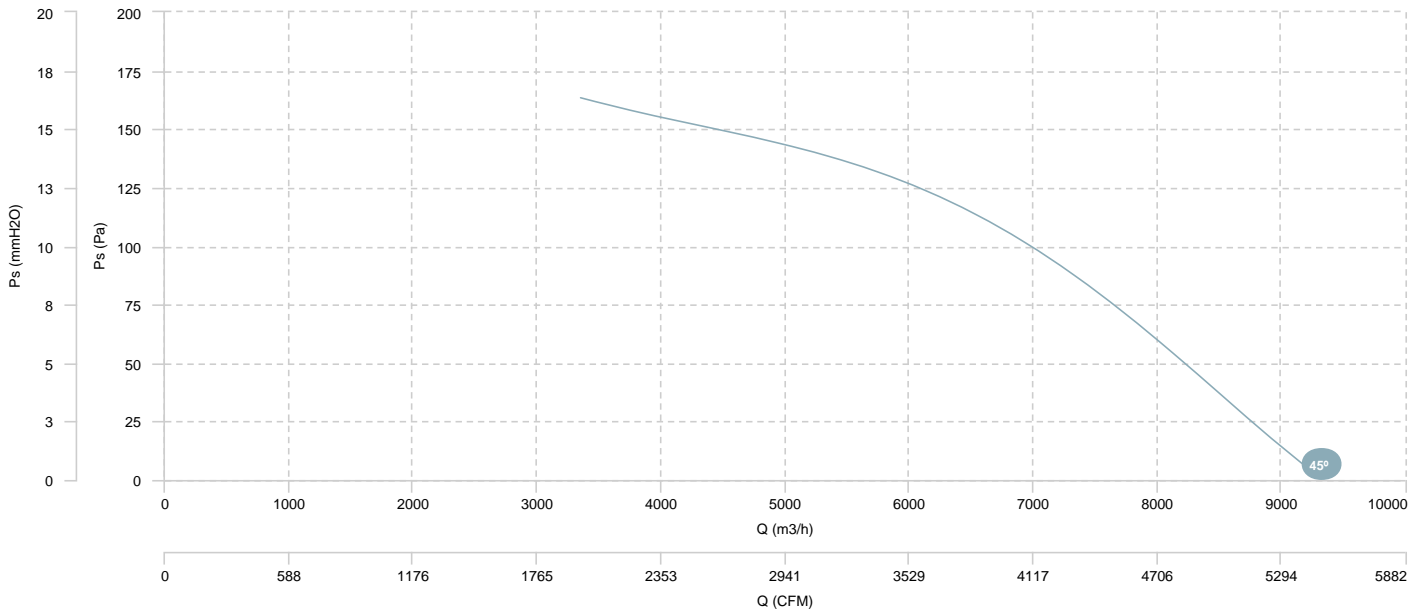

AIR FLOW - ABSORBED POWER

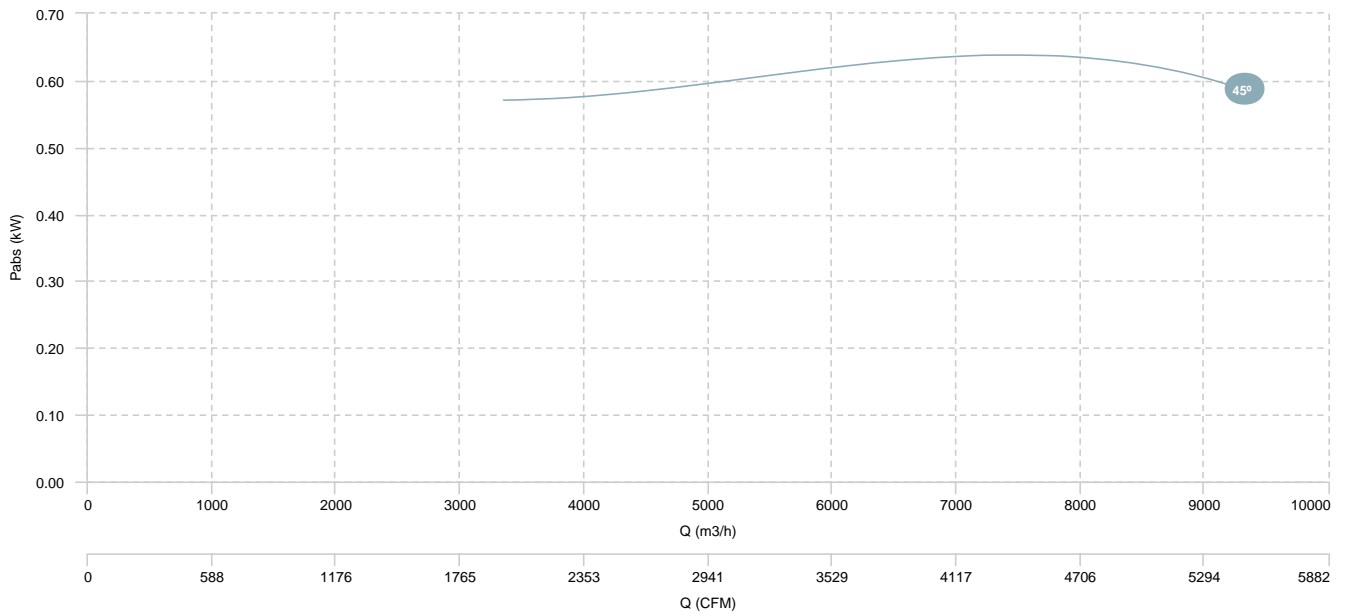

HC 50 T6 0,13kW (A0:6)

AIR FLOW - PRESSURE

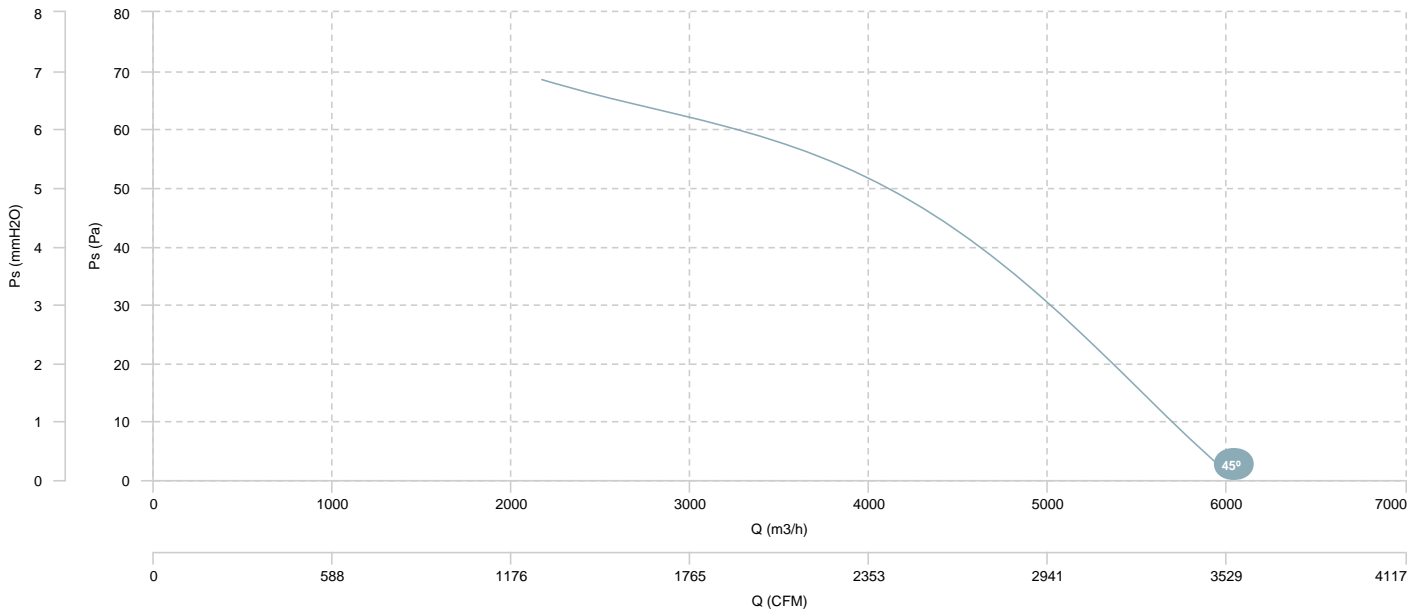

AIR FLOW - ABSORBED POWER

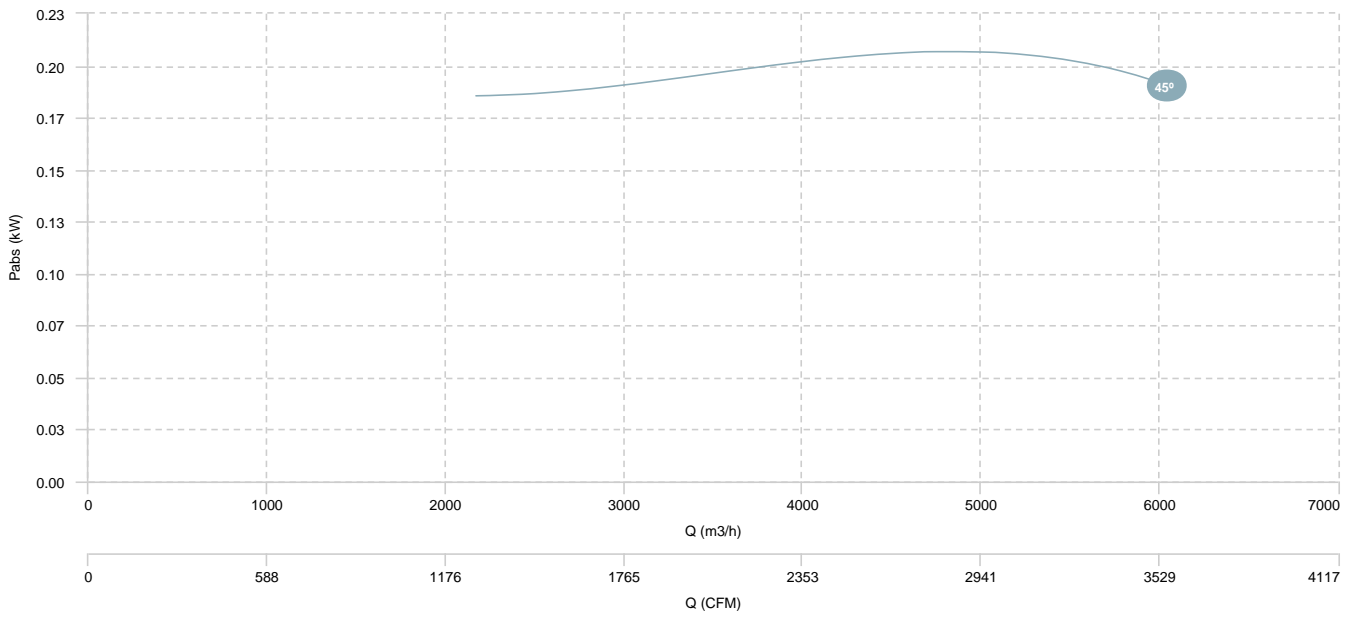

HC 50 T4/T6 0,55/0,18kW (A0:6)

AIR FLOW - PRESSURE (4 POLES)

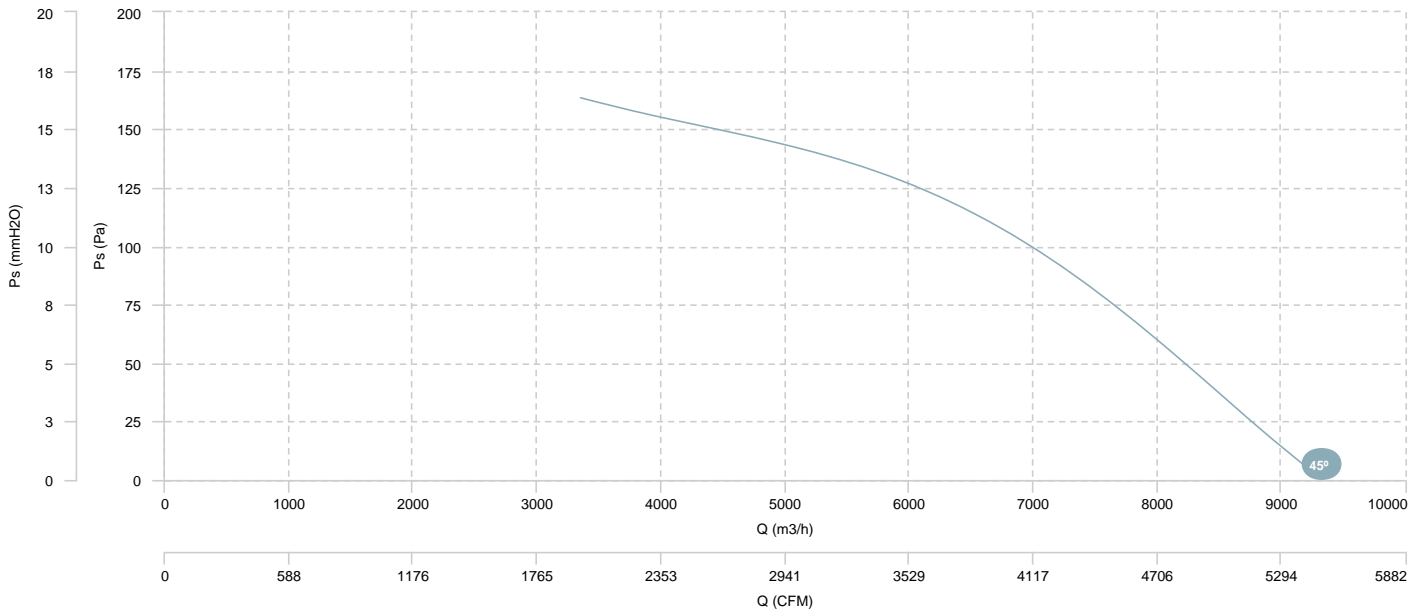

AIR FLOW - ABSORBED POWER (4 POLES)

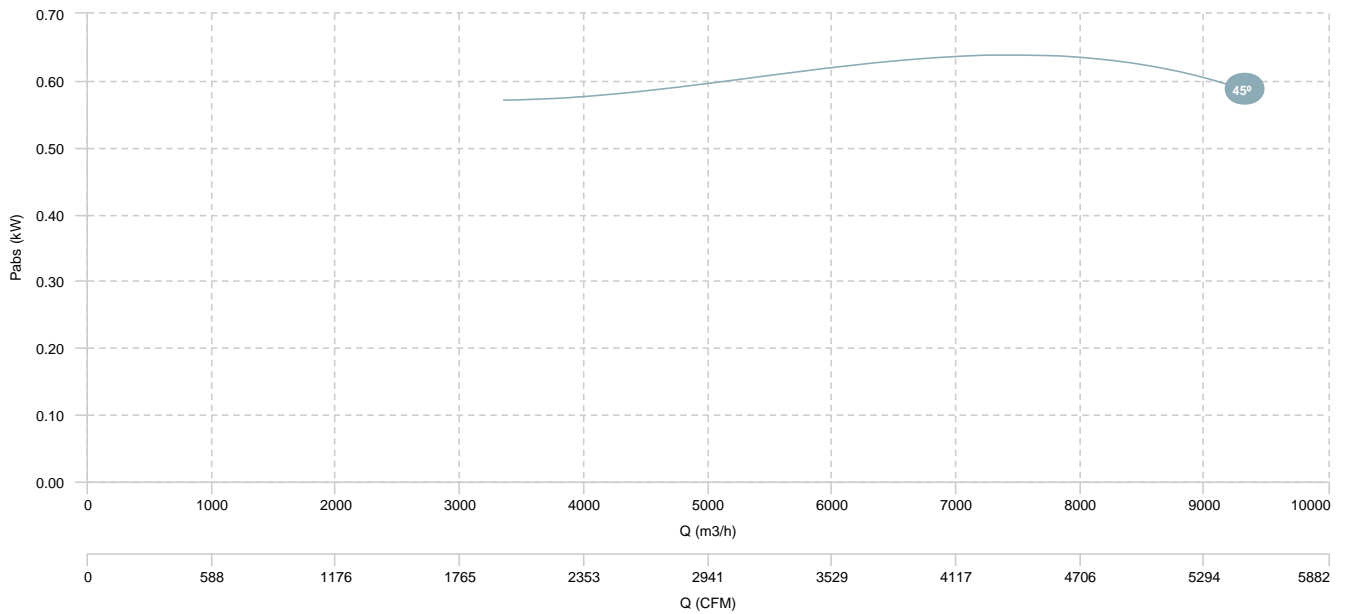

HC 50 T4/T6 0,55/0,18kW (A0:6)

AIR FLOW - PRESSURE (6 POLES)

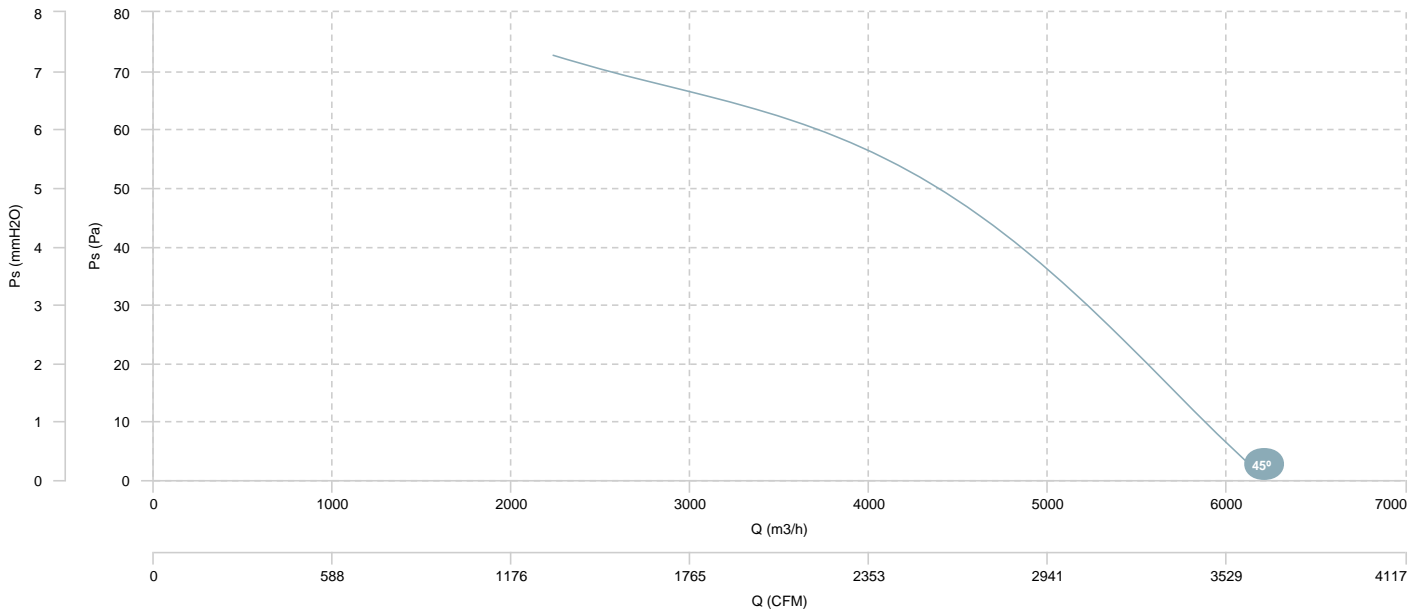

HC 50 T4/T8 0,55/0,09kW (A0:6)

AIR FLOW - PRESSURE (4 POLES)

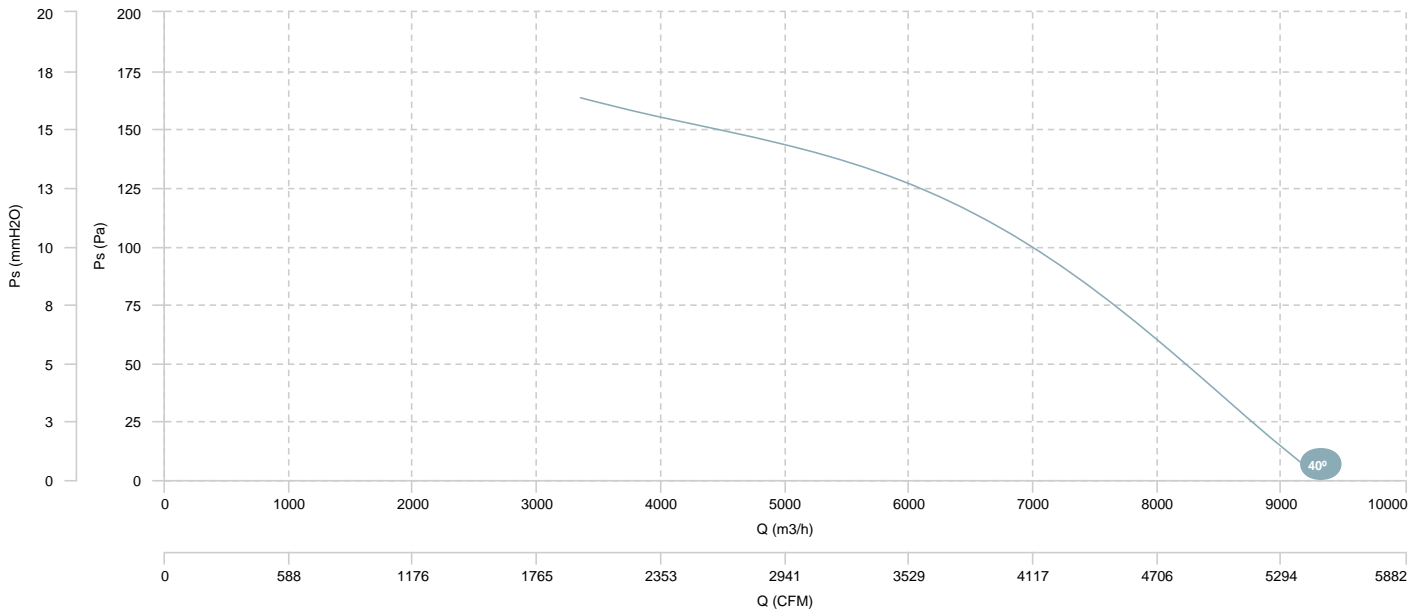

AIR FLOW - ABSORBED POWER (4 POLES)

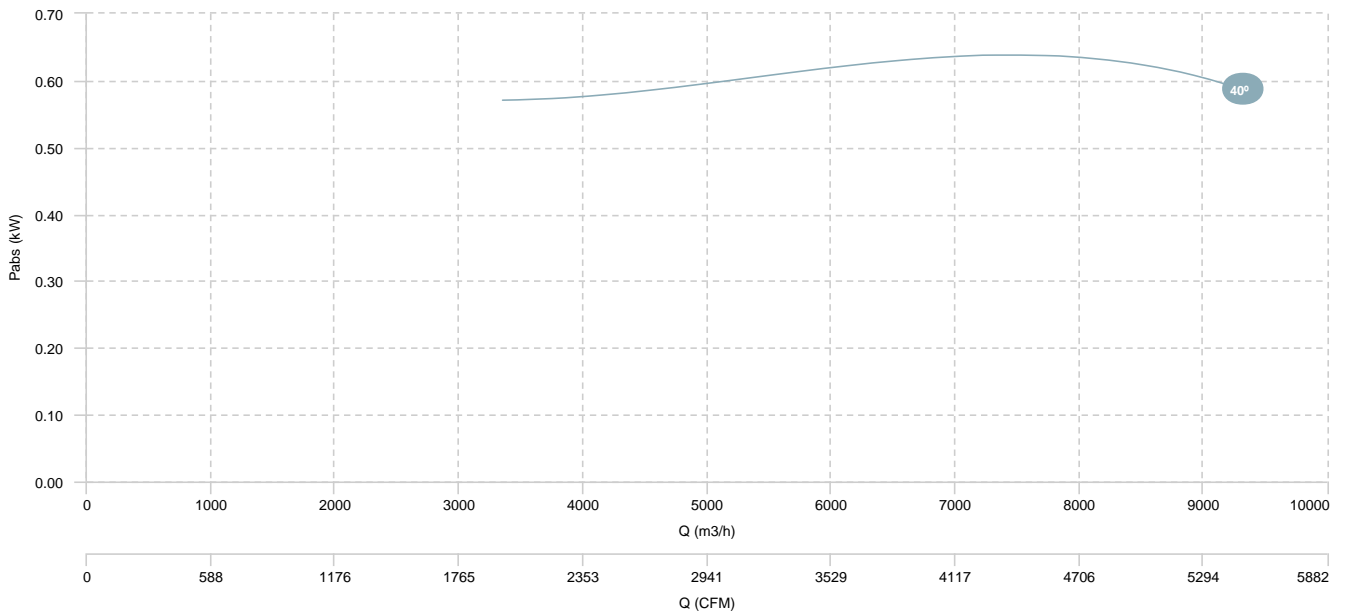

HC 50 T4/T8 0,55/0,09kW (A0:6)

AIR FLOW - PRESSURE (8 POLES)

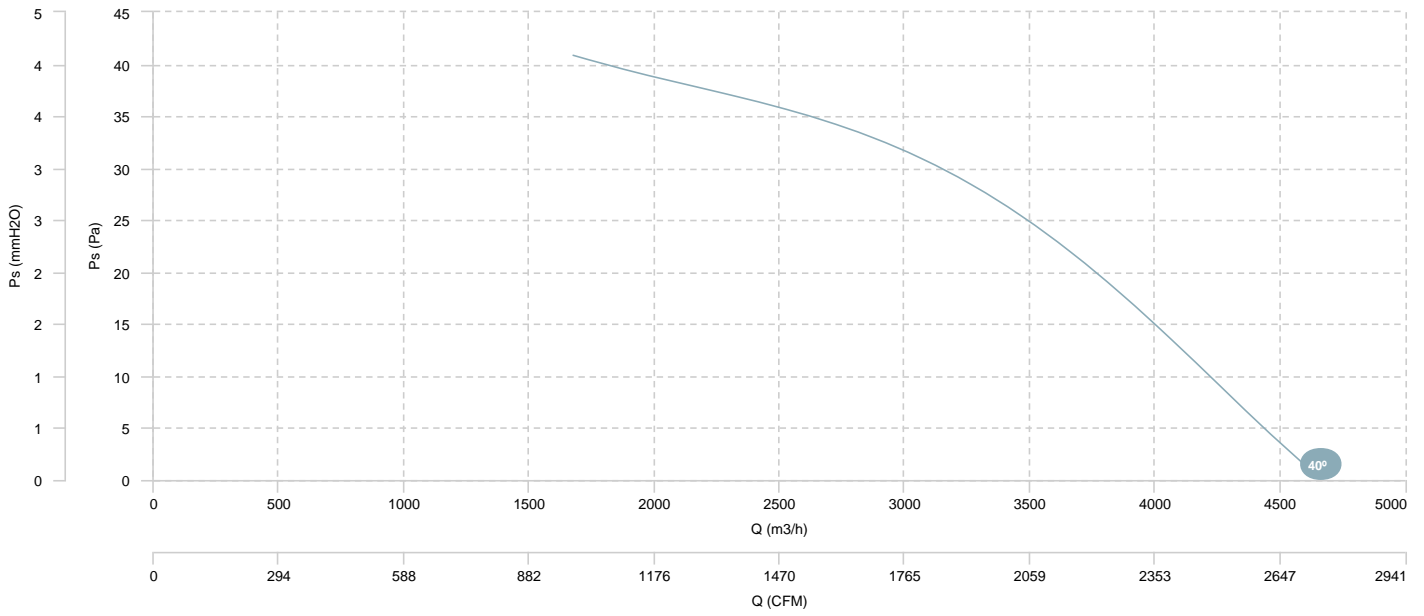

HC 56 T4 0,55kW (A2:9)	HC 56 T4 0,75kW (A2:9)	HC 56 T4 1,1kW (A2:9)
HC 56 T4 1,5kW (A2:9)		

AIR FLOW - PRESSURE

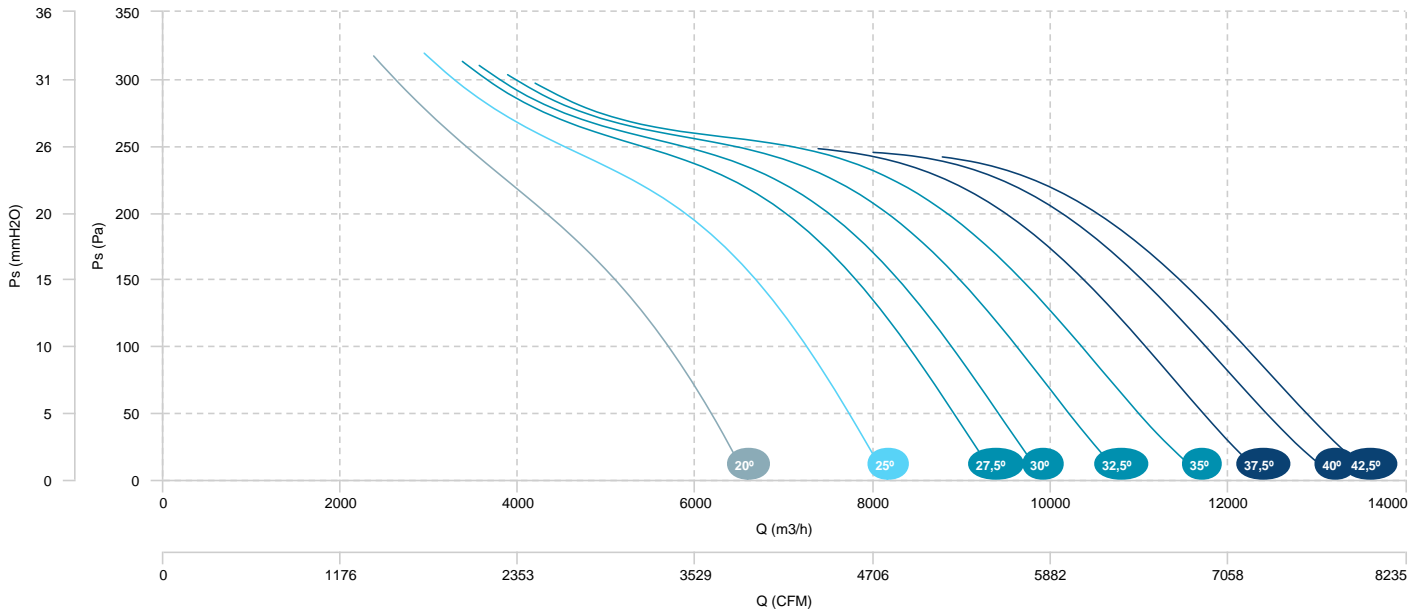

AIR FLOW - ABSORBED POWER

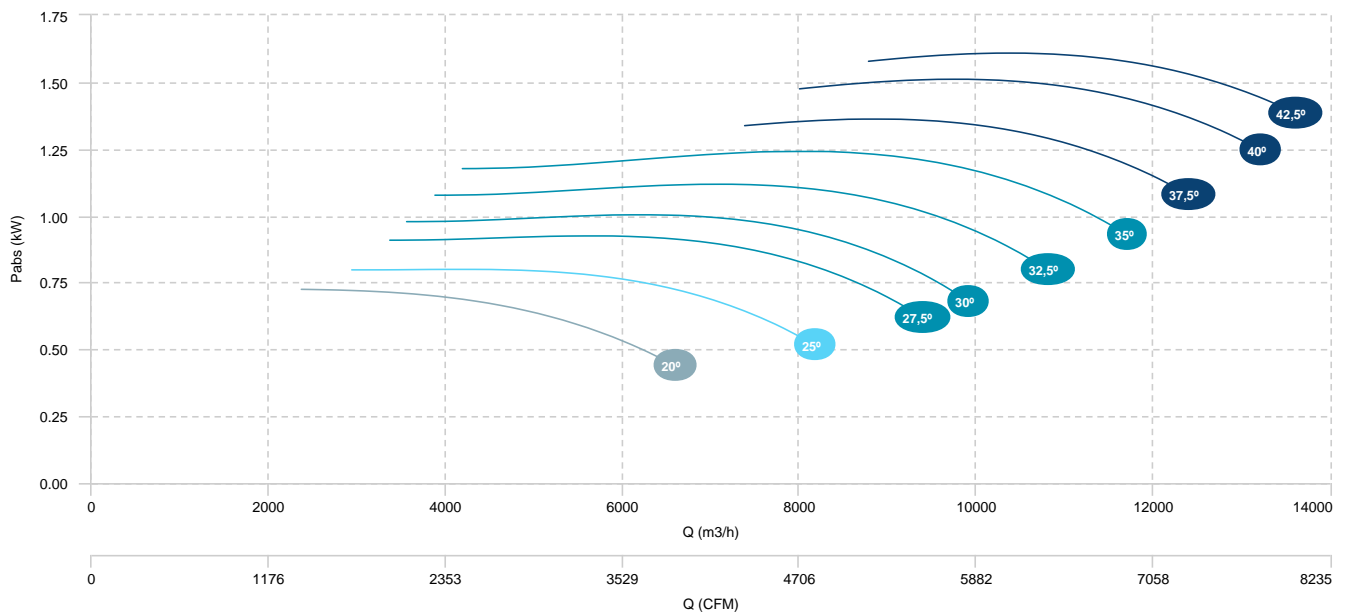

HC 56 T4 0,55kW (A2:6)	HC 56 T4 0,75kW (A2:6)	HC 56 T4 1,1kW (A2:6)
HC 56 T4 1,5kW (A2:6)		

AIR FLOW - PRESSURE

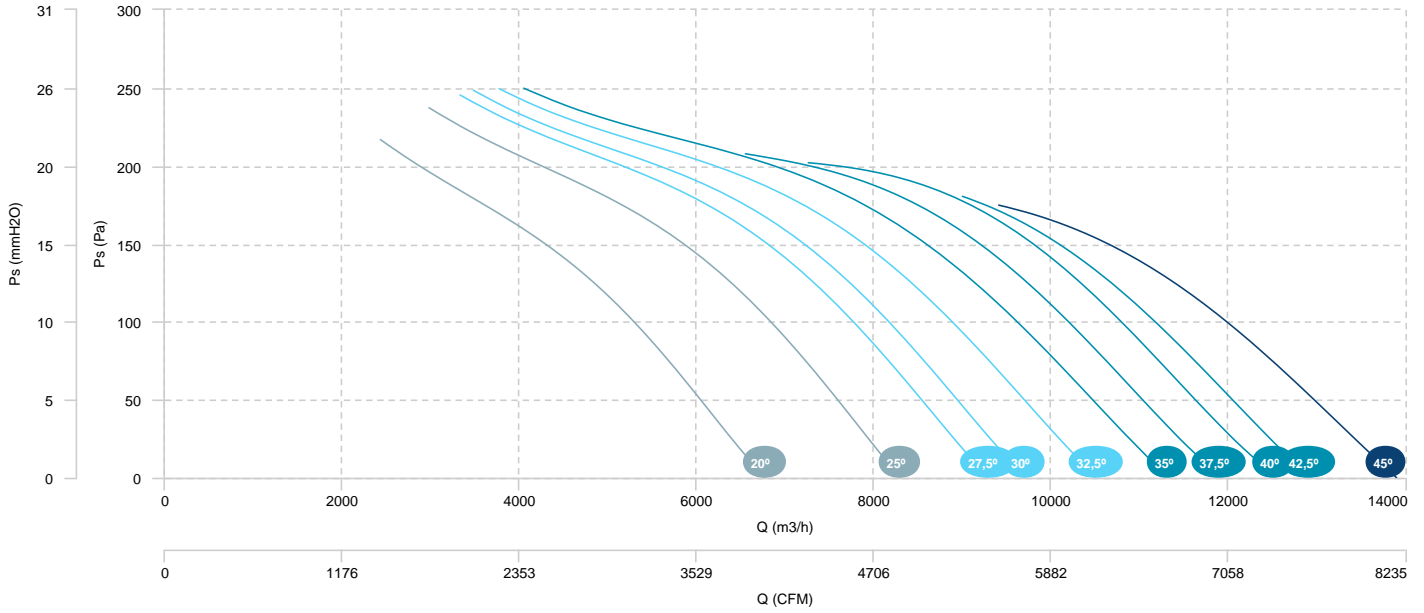

AIR FLOW - ABSORBED POWER

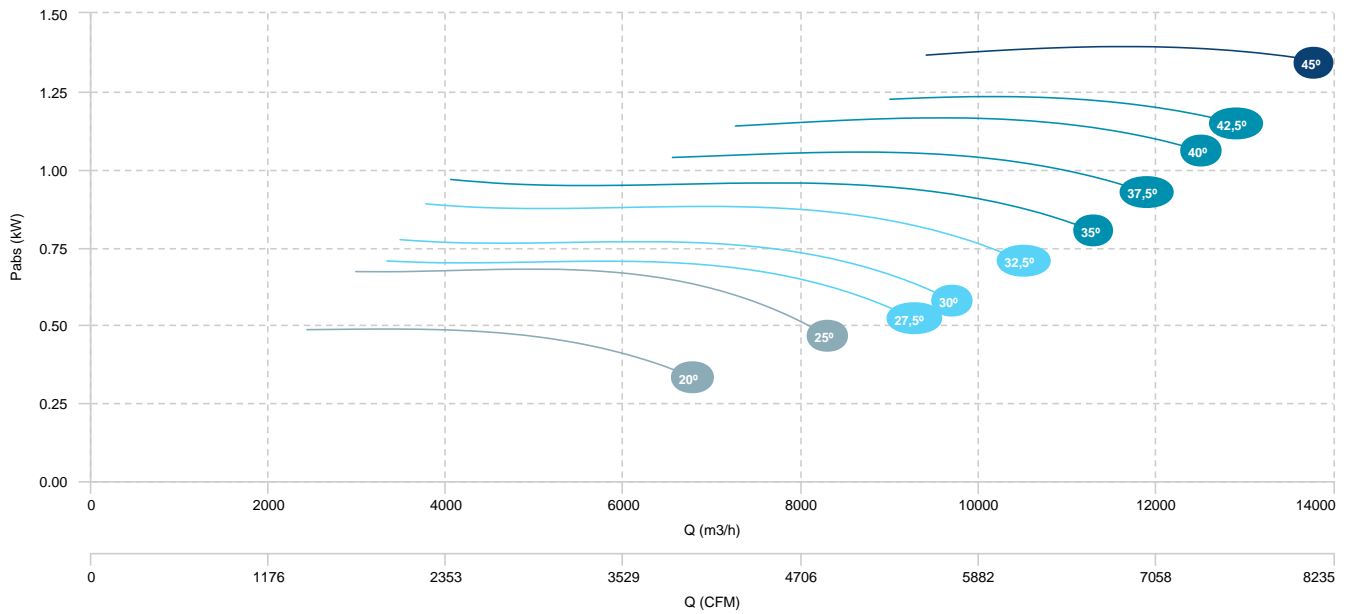

HC 56 T4 0,37kW (A5:6)	HC 56 T4 0,55kW (A5:6)	HC 56 T4 0,75kW (A5:6)
HC 56 T4 1,1kW (A5:6)	HC 56 T4 1,5kW (A5:6)	

AIR FLOW - PRESSURE

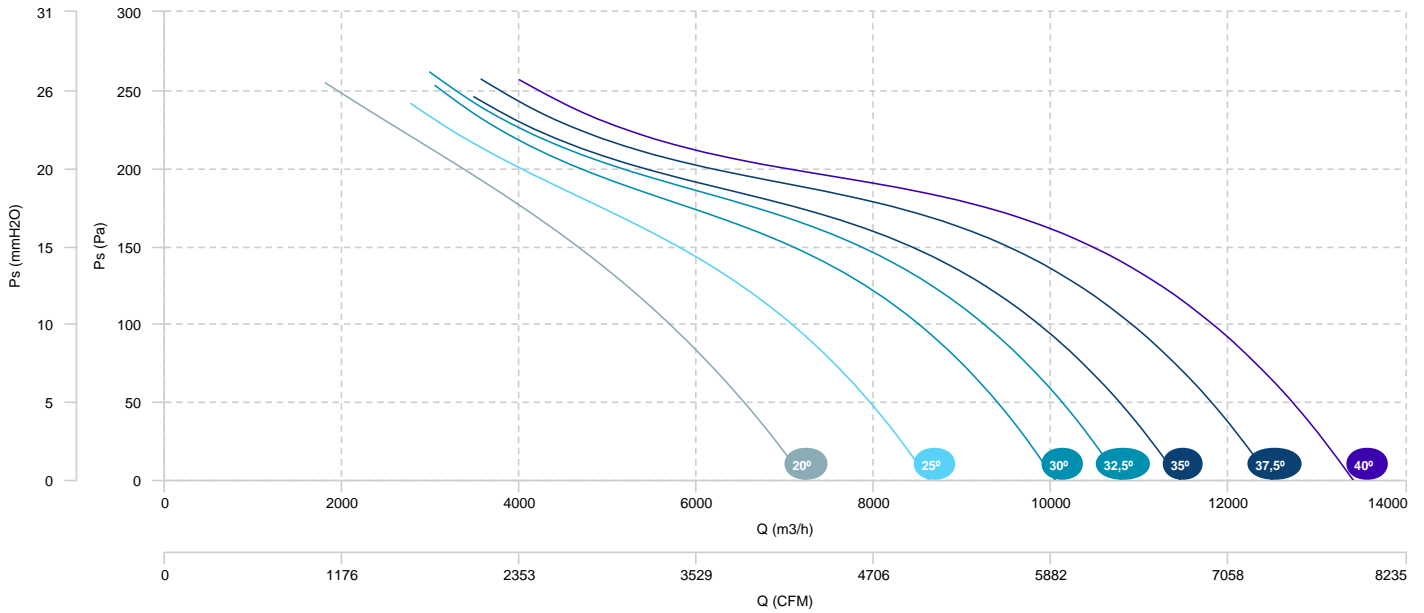

AIR FLOW - ABSORBED POWER

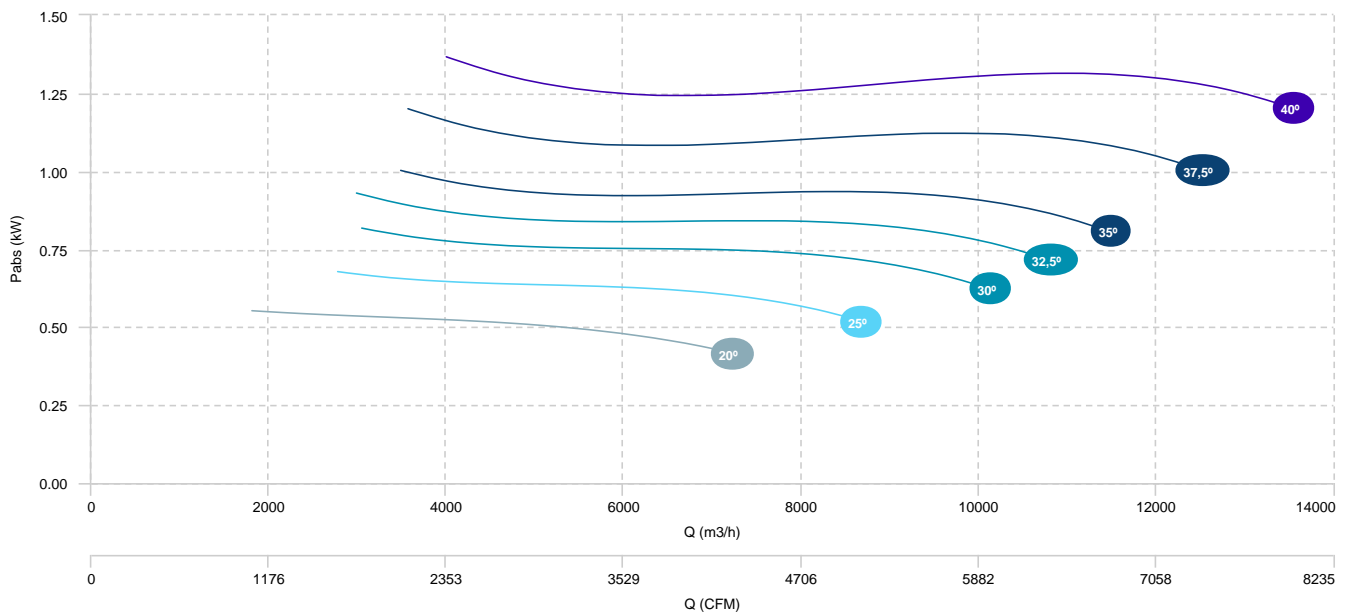

HC 56 T6 0,55kW (A2:9)

AIR FLOW - PRESSURE

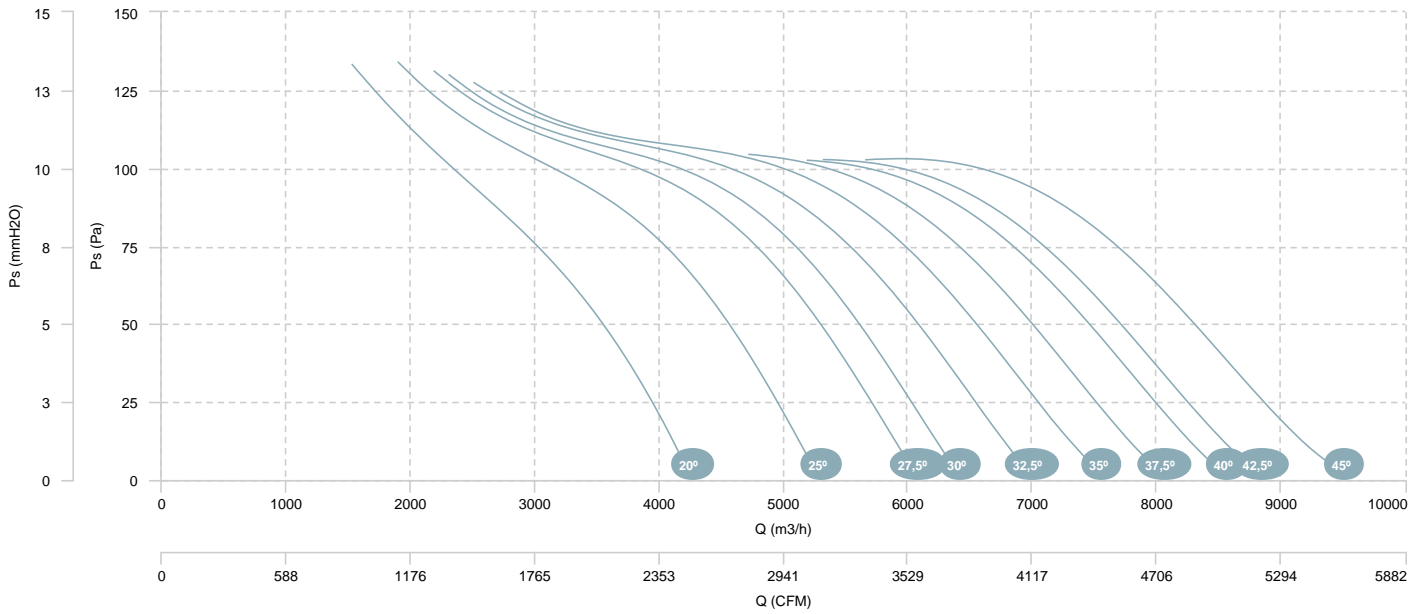

AIR FLOW - ABSORBED POWER

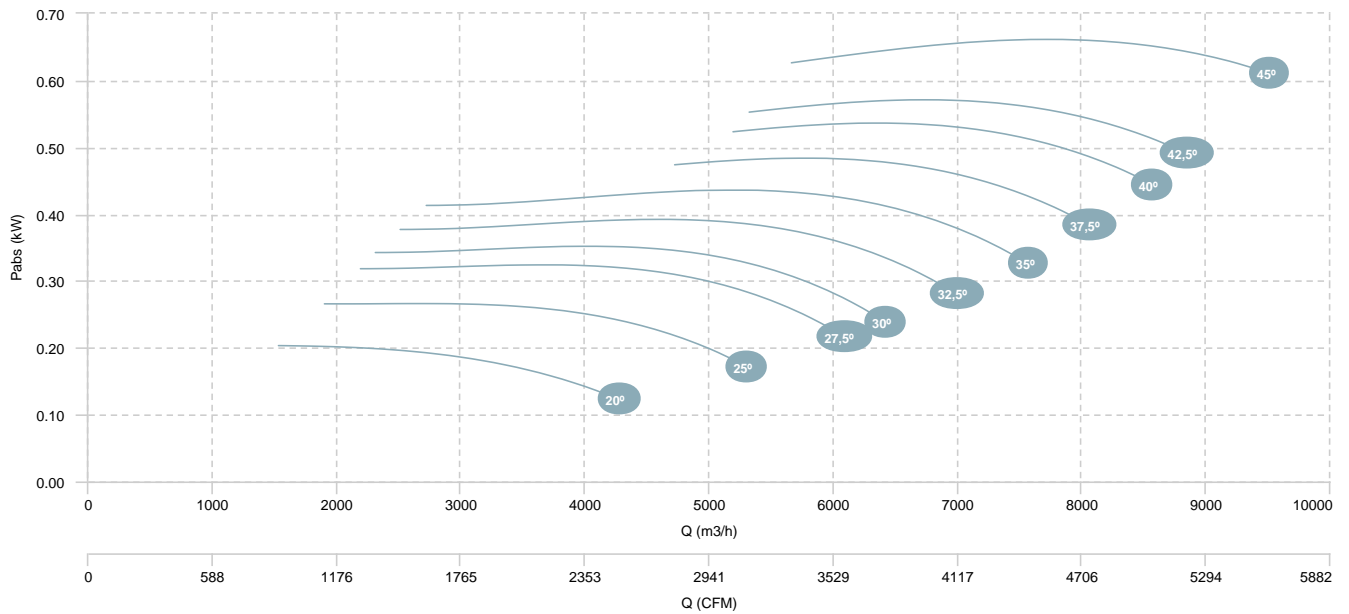

HC 56 T6 0,55kW (A2:6)

AIR FLOW - PRESSURE

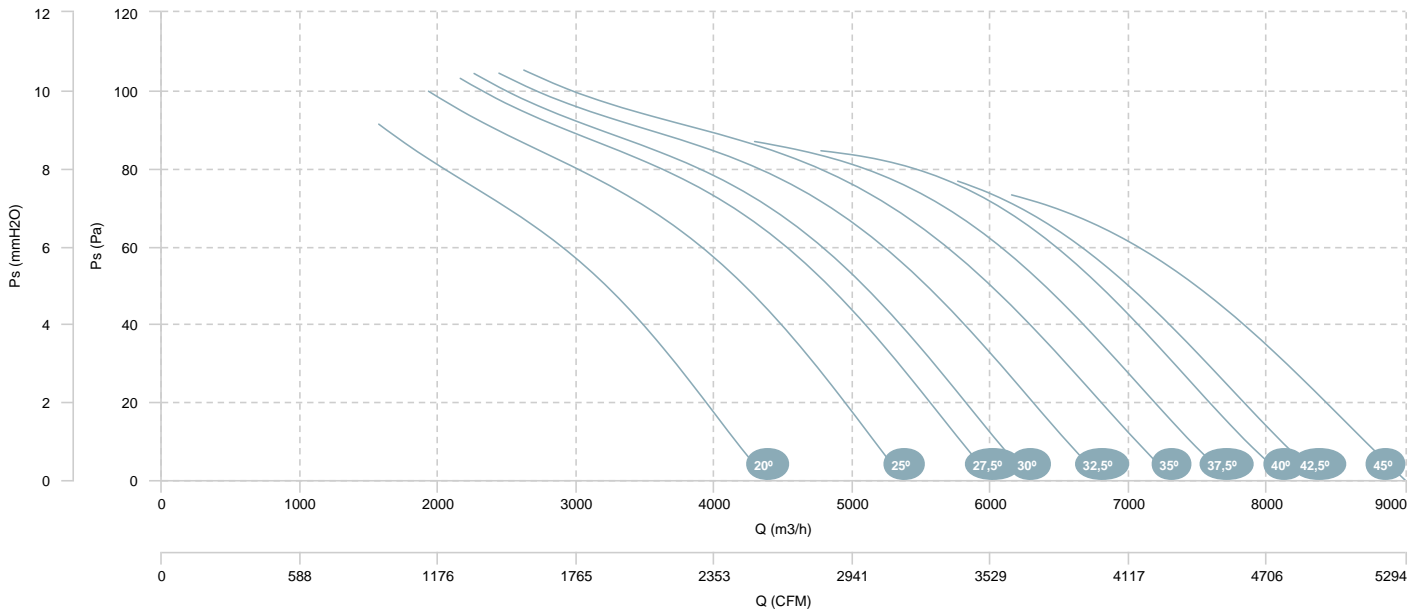

AIR FLOW - ABSORBED POWER



HC 56 T6 0,25kW (A5:6)

HC 56 T6 0,37kW (A5:6)

AIR FLOW - PRESSURE

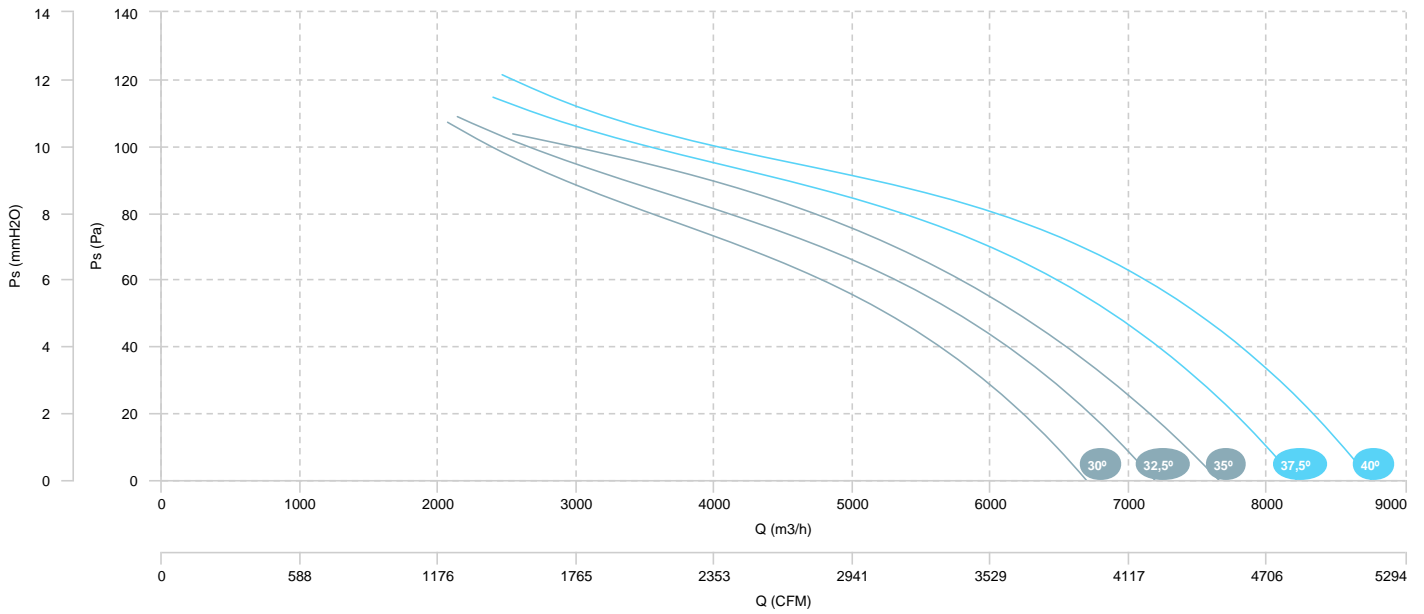

AIR FLOW - ABSORBED POWER

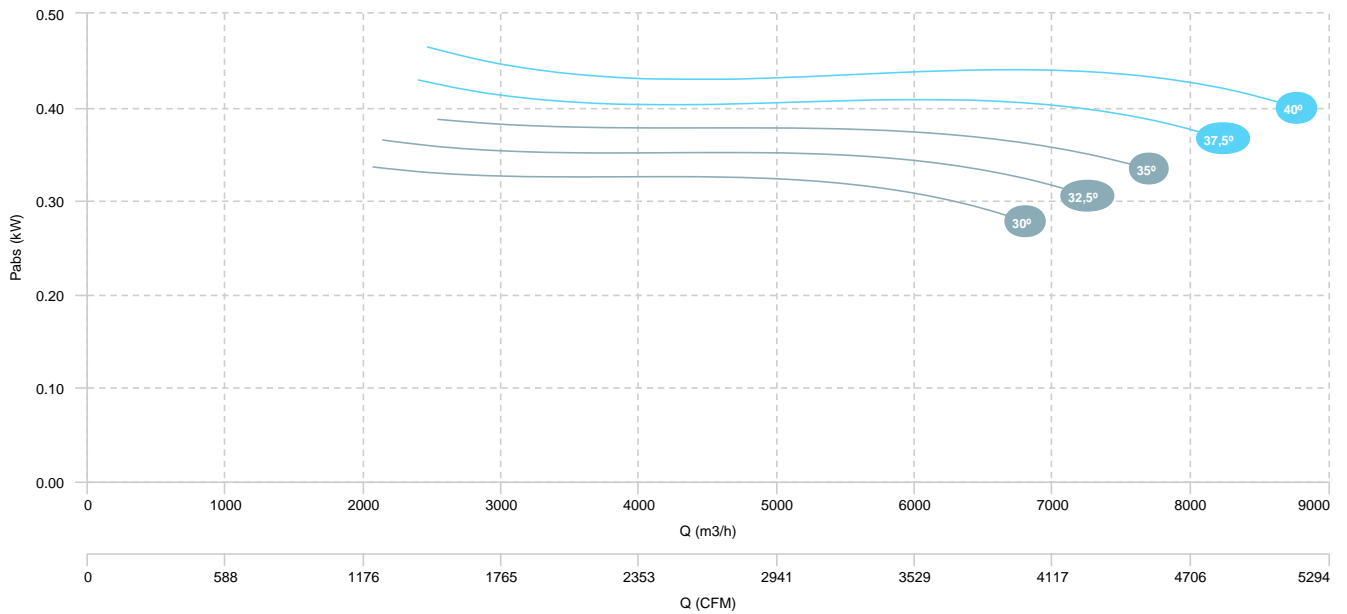

HC 56 T4/T6 0,55/0,18kW (A2:6)	HC 56 T4/T6 0,75/0,25kW (A2:6)	HC 56 T4/T6 1,1/0,37kW (A2:6)
HC 56 T4/T6 1,5/0,5kW (A2:6)		

AIR FLOW - PRESSURE (4 POLES)

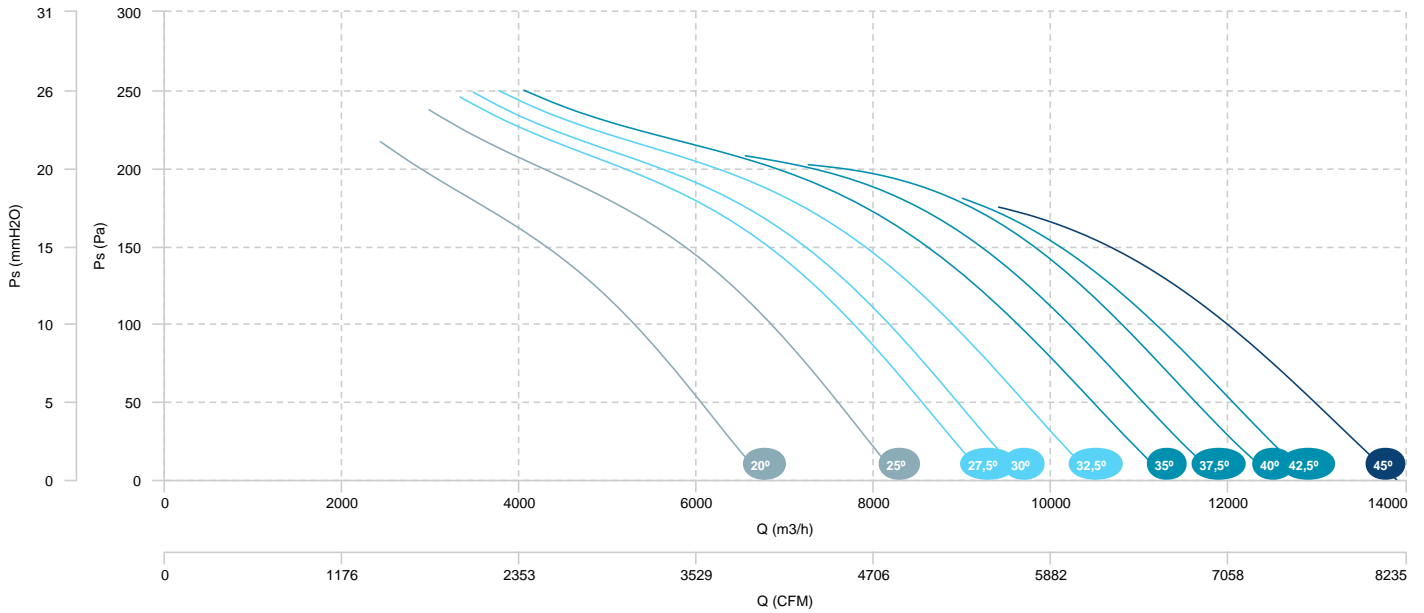

AIR FLOW - ABSORBED POWER (4 POLES)

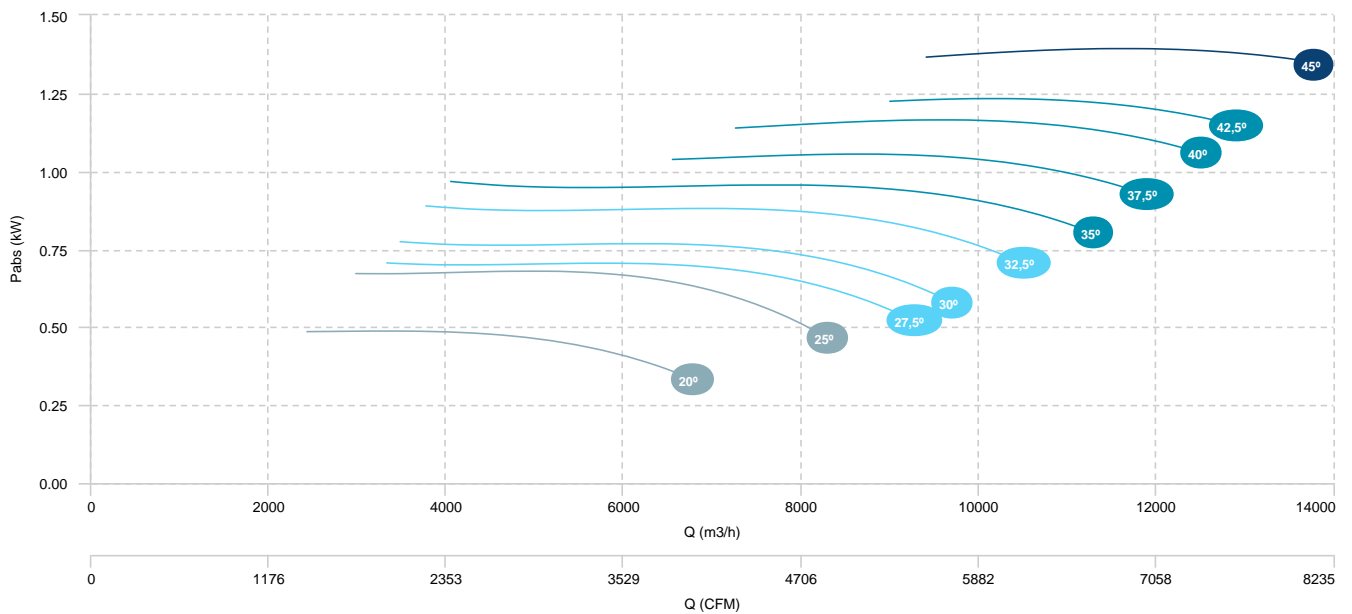

HC 56 T4/T6 0,55/0,18kW (A2:6)	HC 56 T4/T6 0,75/0,25kW (A2:6)	HC 56 T4/T6 1,1/0,37kW (A2:6)
HC 56 T4/T6 1,5/0,5kW (A2:6)		

AIR FLOW - PRESSURE (6 POLES)

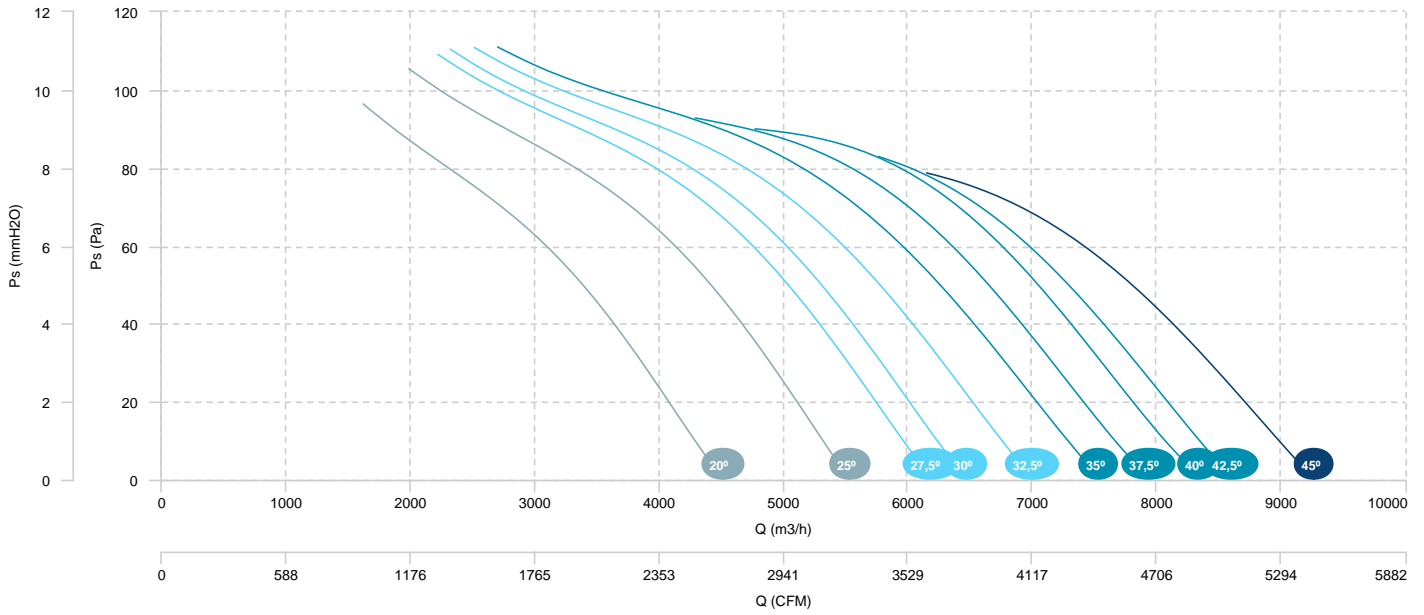

HC 56 T4/T6 0,55/0,18kW (A2:9)	HC 56 T4/T6 0,75/0,25kW (A2:9)	HC 56 T4/T6 1,1/0,37kW (A2:9)
HC 56 T4/T6 1,5/0,5kW (A2:9)		

AIR FLOW - PRESSURE (4 POLES)

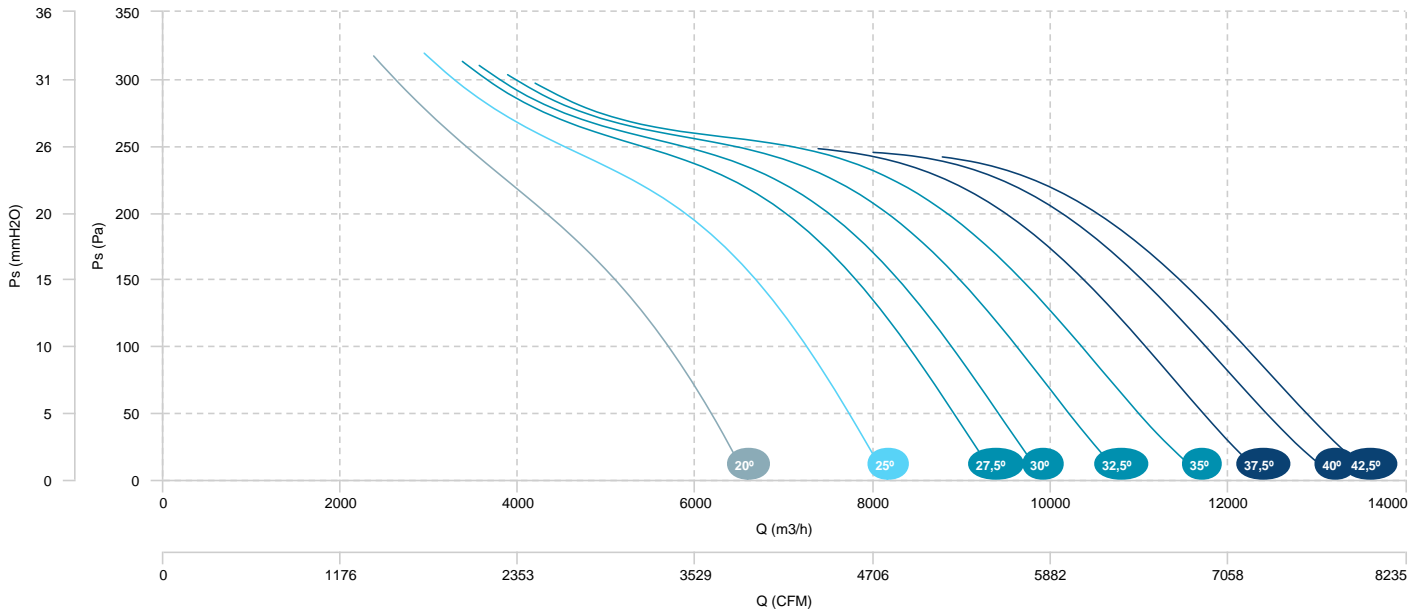

AIR FLOW - ABSORBED POWER (4 POLES)

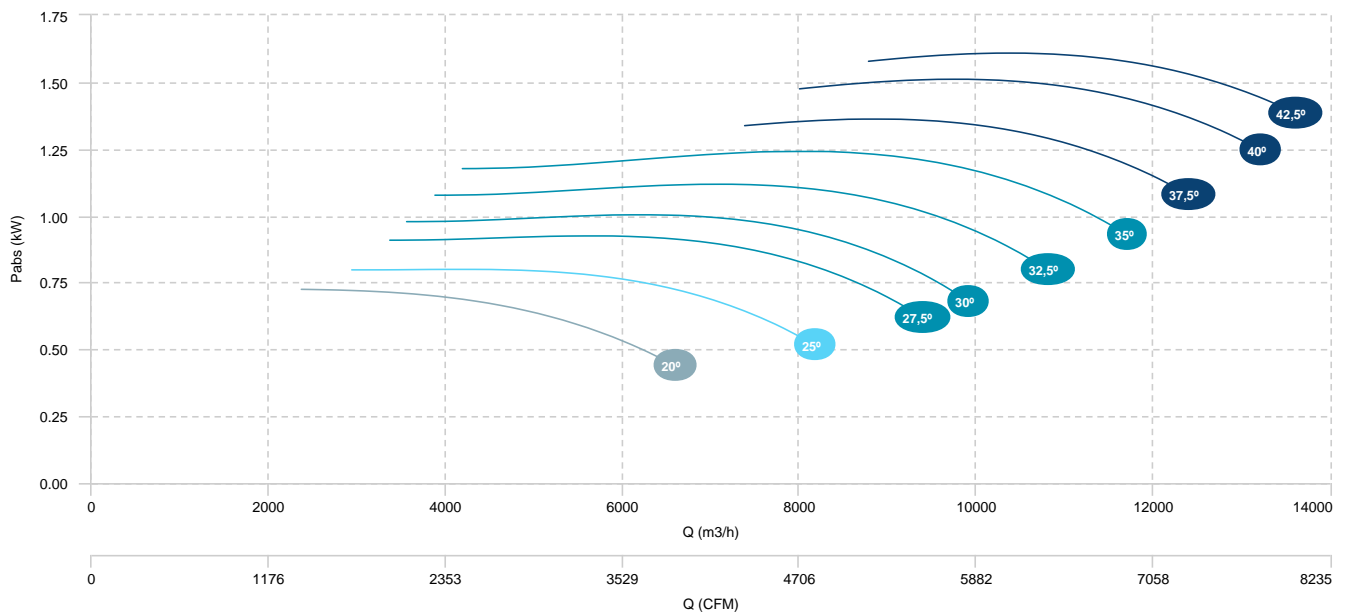

HC 56 T4/T6 0,55/0,18kW (A2:9)	HC 56 T4/T6 0,75/0,25kW (A2:9)	HC 56 T4/T6 1,1/0,37kW (A2:9)
HC 56 T4/T6 1,5/0,5kW (A2:9)		

AIR FLOW - PRESSURE (6 POLES)

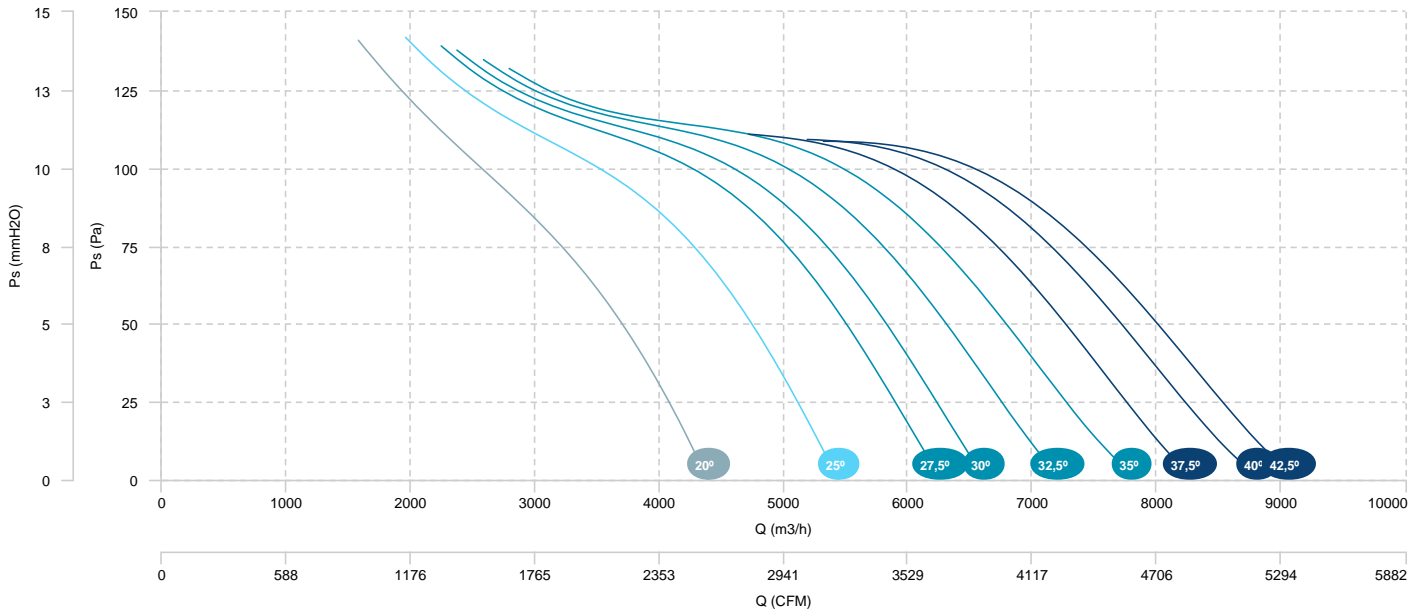

HC 56 T4/T6 0,37/0,13kW (A5:6)	HC 56 T4/T6 0,55/0,18kW (A5:6)	HC 56 T4/T6 0,75/0,25kW (A5:6)
HC 56 T4/T6 1,1/0,37kW (A5:6)	HC 56 T4/T6 1,5/0,5kW (A5:6)	

AIR FLOW - PRESSURE (4 POLES)

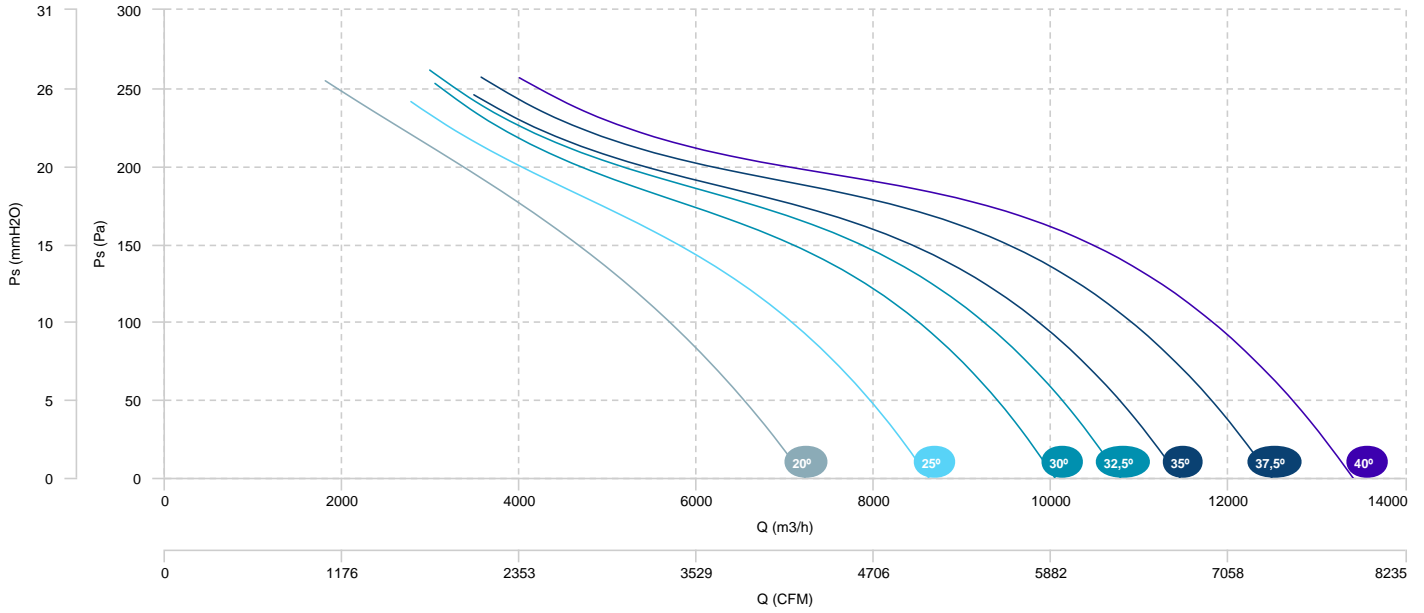

AIR FLOW - ABSORBED POWER (4 POLES)

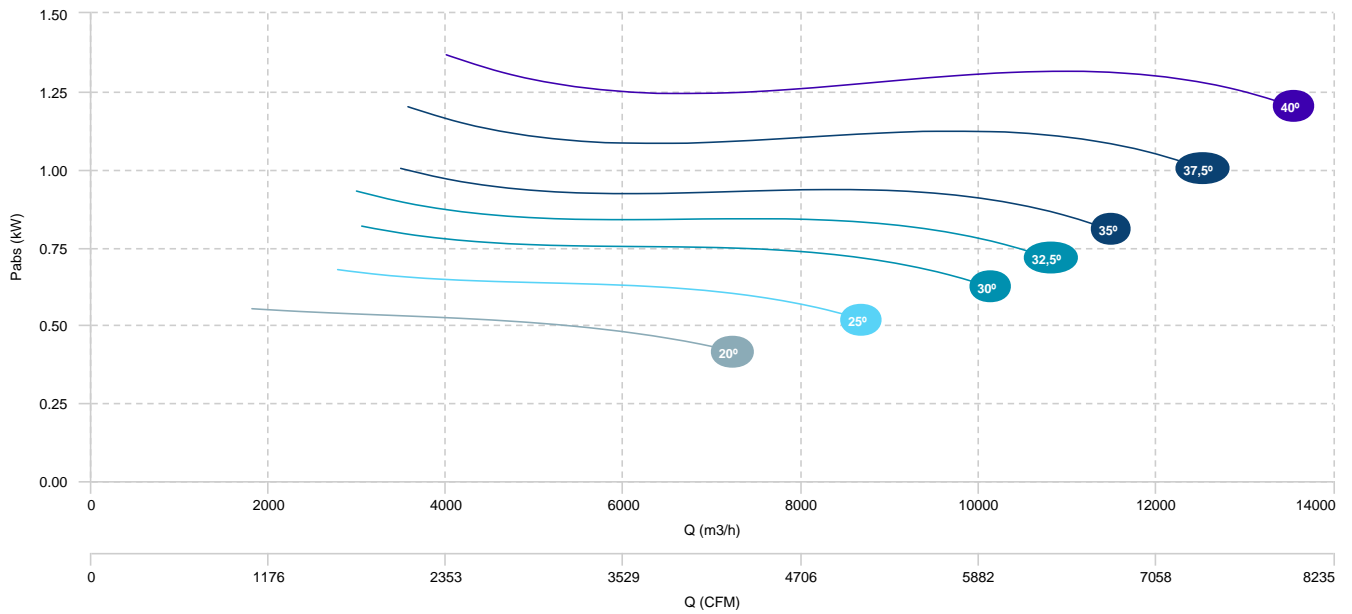

HC 56 T4/T6 0,37/0,13kW (A5:6)	HC 56 T4/T6 0,55/0,18kW (A5:6)	HC 56 T4/T6 0,75/0,25kW (A5:6)
HC 56 T4/T6 1,1/0,37kW (A5:6)	HC 56 T4/T6 1,5/0,5kW (A5:6)	

AIR FLOW - PRESSURE (6 POLES)

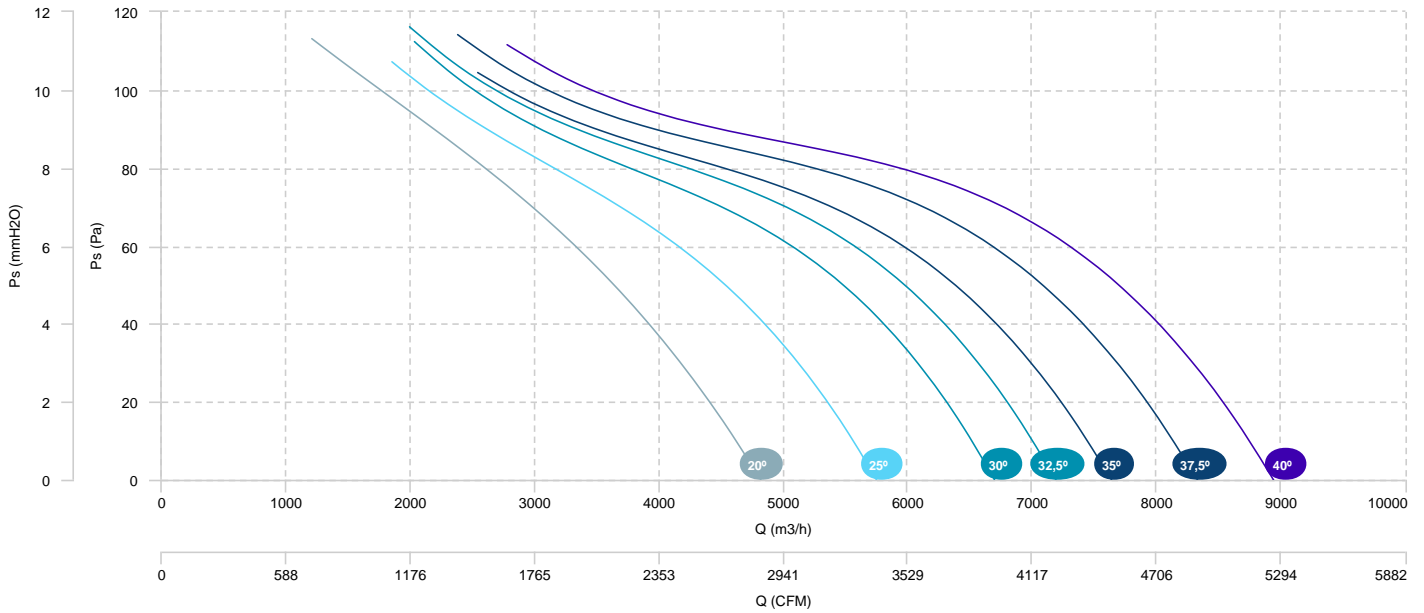

HC 56 T4/T8 0,55/0,09kW (A2:6)	HC 56 T4/T8 0,75/0,12kW (A2:6)	HC 56 T4/T8 1,1/0,18kW (A2:6)
HC 56 T4/T8 1,5/0,25kW (A2:6)		

AIR FLOW - PRESSURE (4 POLES)

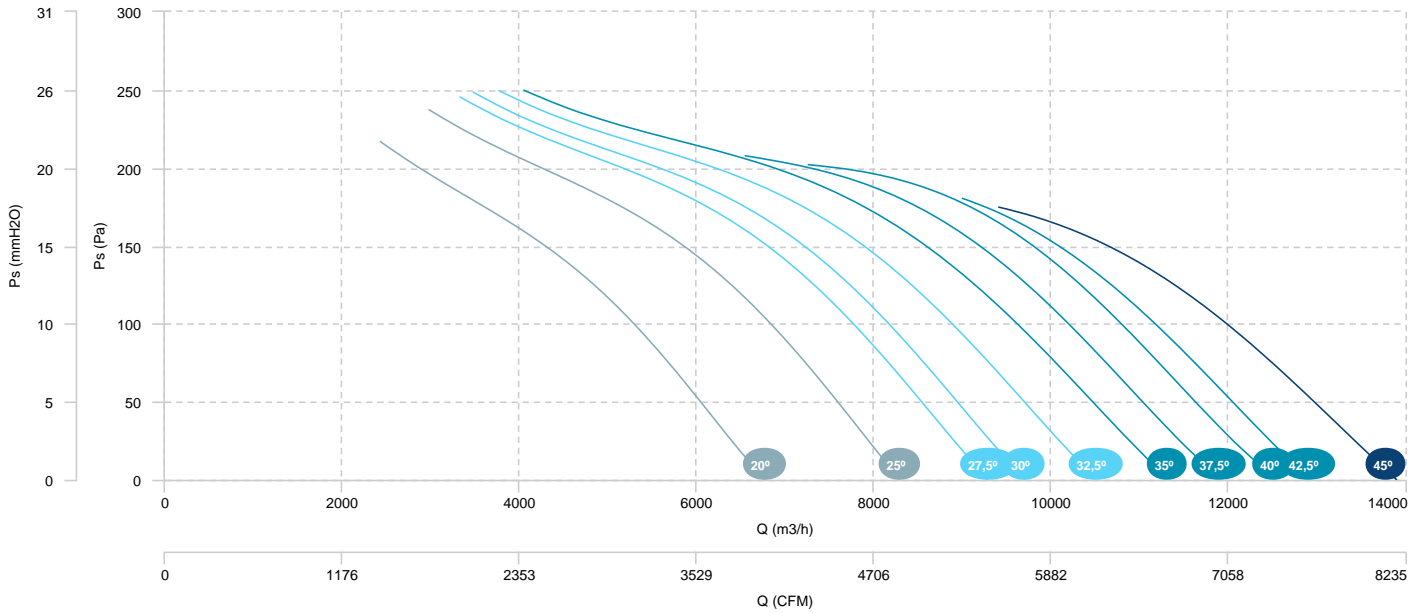

AIR FLOW - ABSORBED POWER (4 POLES)

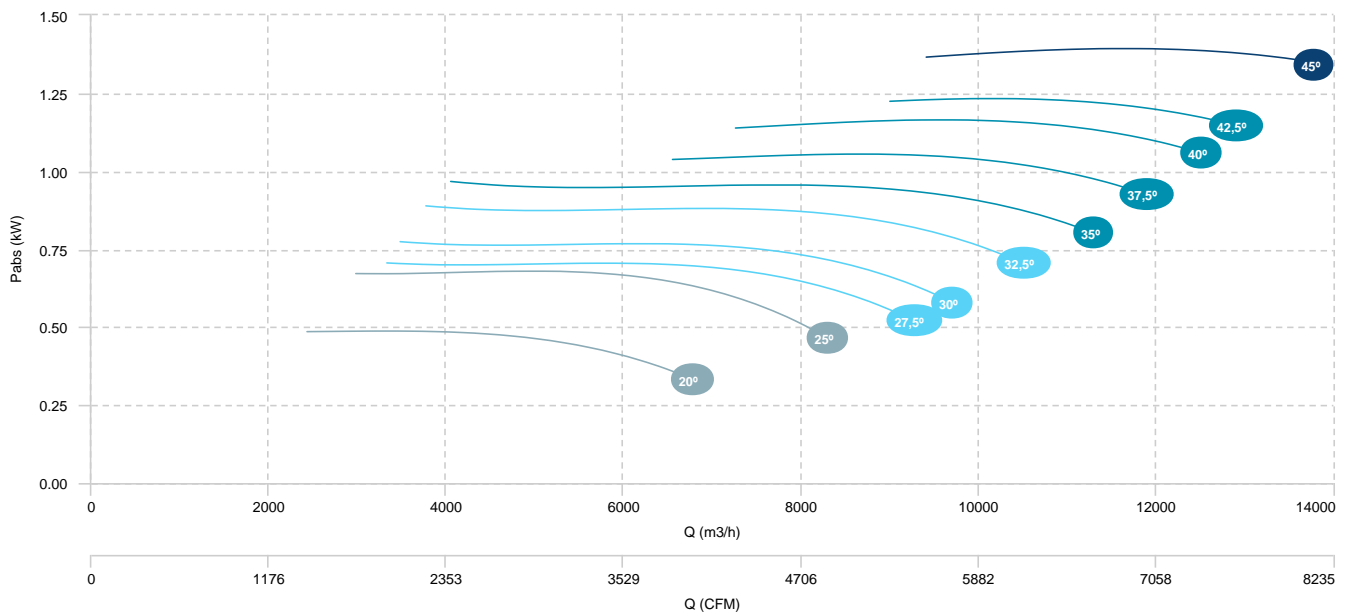

HC 56 T4/T8 0,55/0,09kW (A2:6)	HC 56 T4/T8 0,75/0,12kW (A2:6)	HC 56 T4/T8 1,1/0,18kW (A2:6)
HC 56 T4/T8 1,5/0,25kW (A2:6)		

AIR FLOW - PRESSURE (8 POLES)

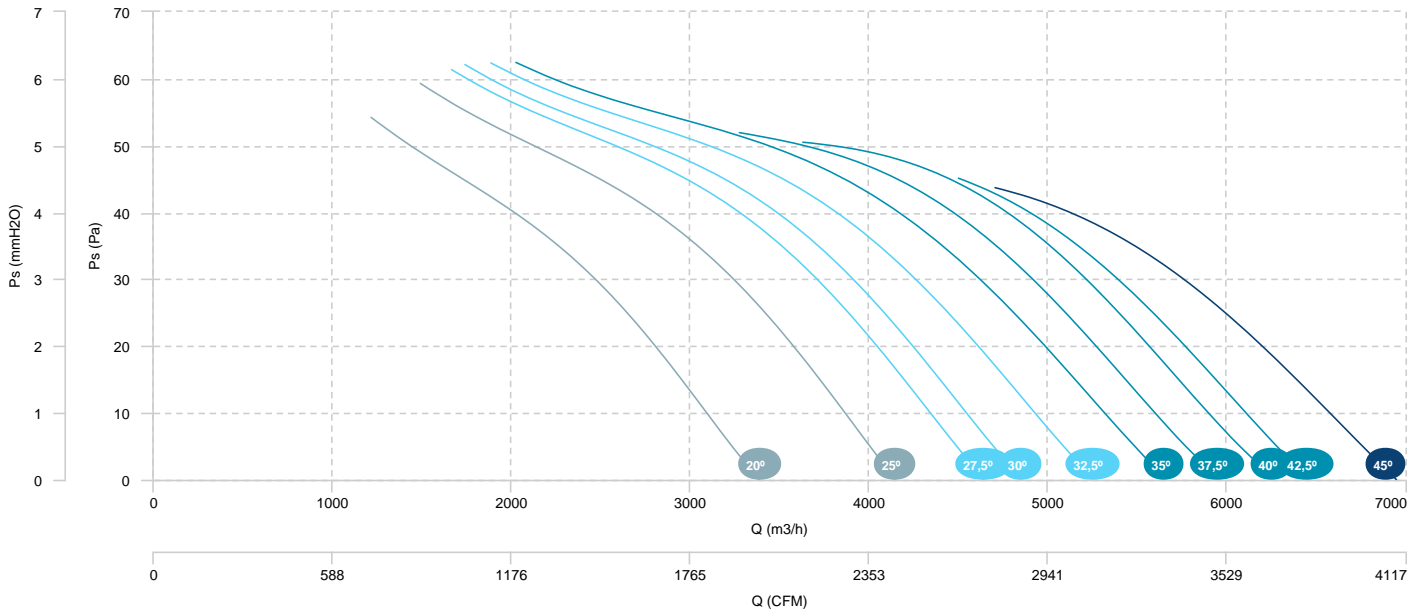

HC 56 T4/T8 0,55/0,09kW (A2:9)	HC 56 T4/T8 0,75/0,12kW (A2:9)	HC 56 T4/T8 1,1/0,18kW (A2:9)
HC 56 T4/T8 1,5/0,25kW (A2:9)		

AIR FLOW - PRESSURE (4 POLES)

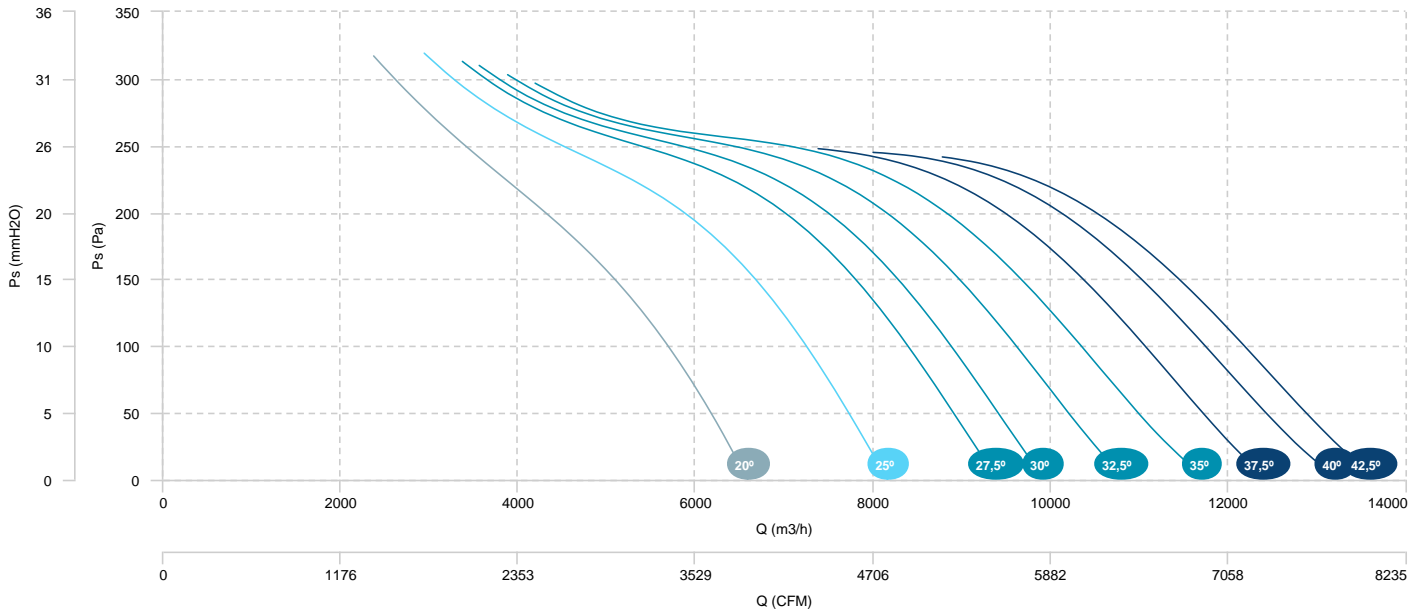

AIR FLOW - ABSORBED POWER (4 POLES)

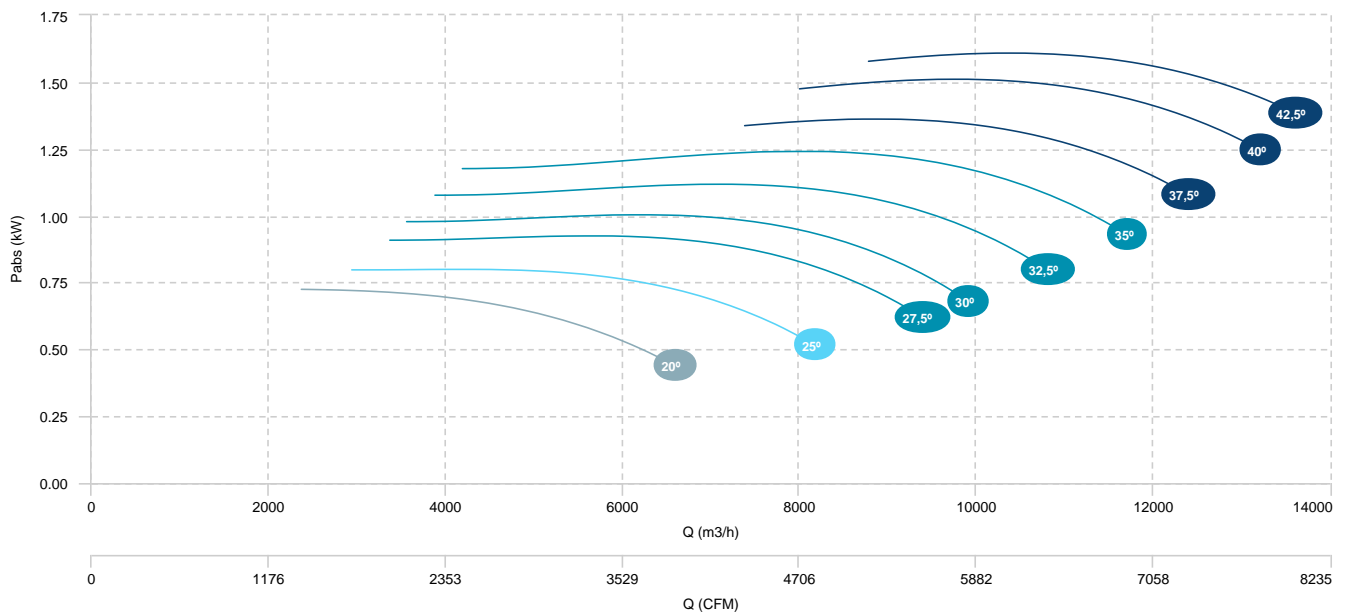

HC 56 T4/T8 0,55/0,09kW (A2:9)	HC 56 T4/T8 0,75/0,12kW (A2:9)	HC 56 T4/T8 1,1/0,18kW (A2:9)
HC 56 T4/T8 1,5/0,25kW (A2:9)		

AIR FLOW - PRESSURE (8 POLES)

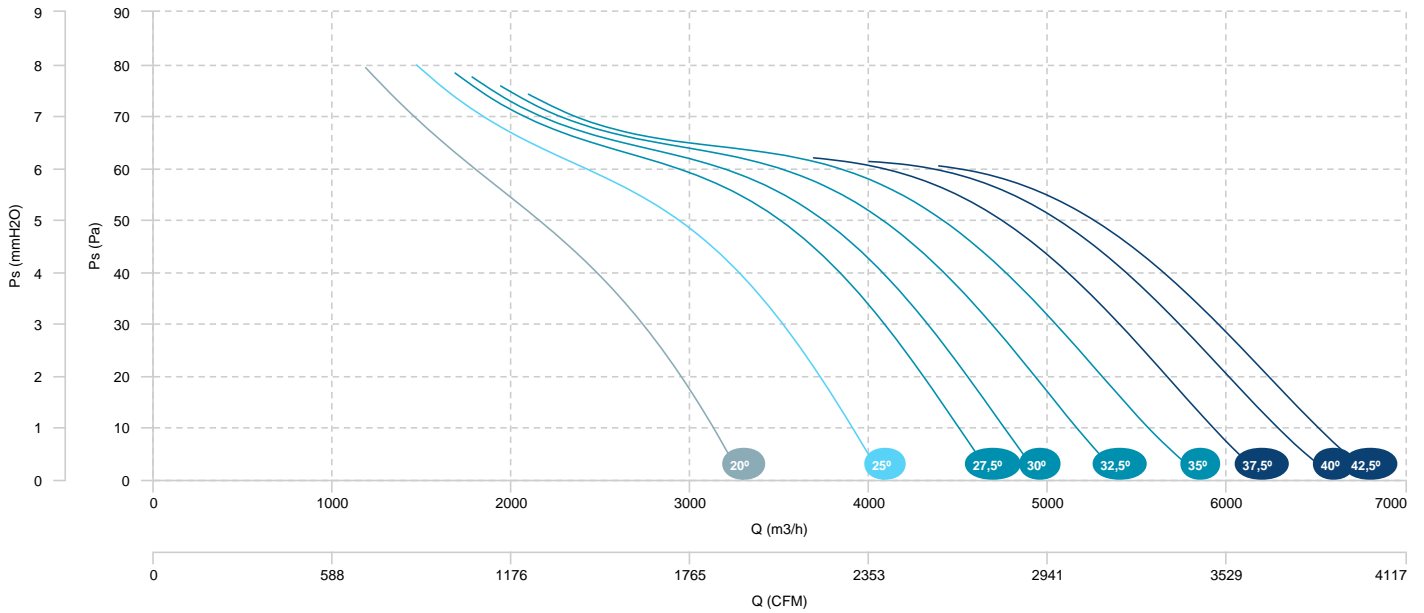

HC 56 T4/T8 0,33/0,04kW (A5:6)	HC 56 T4/T8 0,55/0,09kW (A5:6)	HC 56 T4/T8 0,75/0,12kW (A5:6)
HC 56 T4/T8 1,1/0,18kW (A5:6)	HC 56 T4/T8 1,5/0,25kW (A5:6)	

AIR FLOW - PRESSURE (4 POLES)

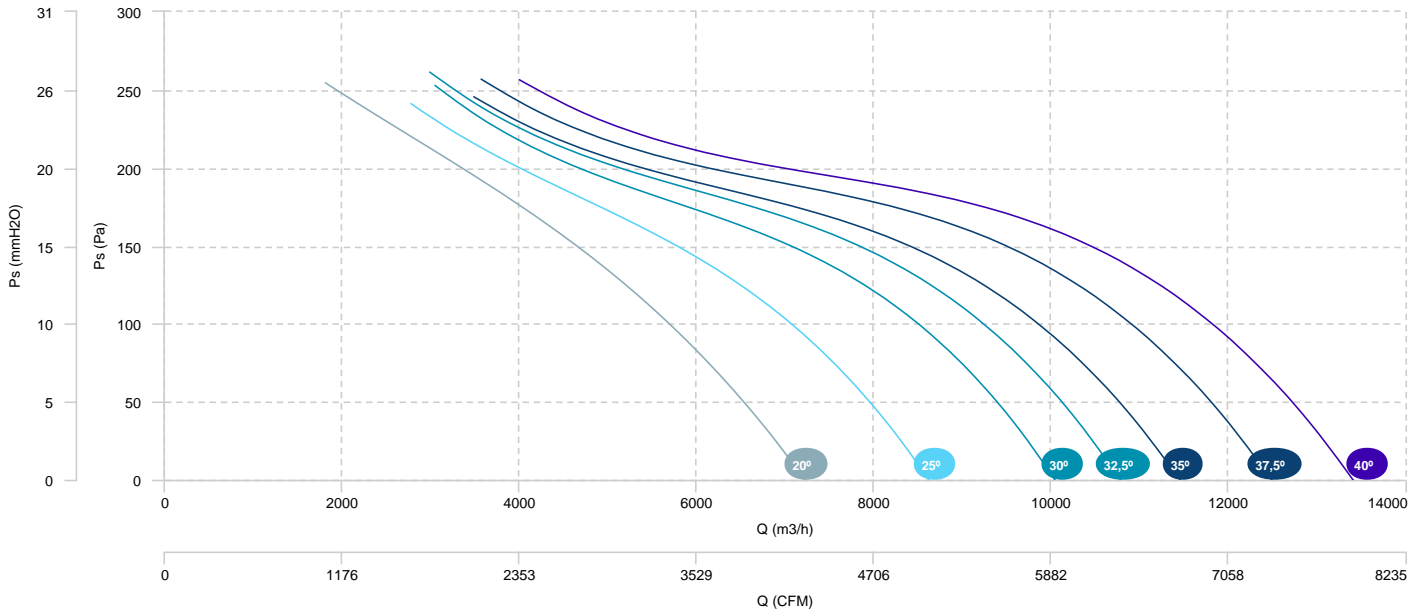

AIR FLOW - ABSORBED POWER (4 POLES)

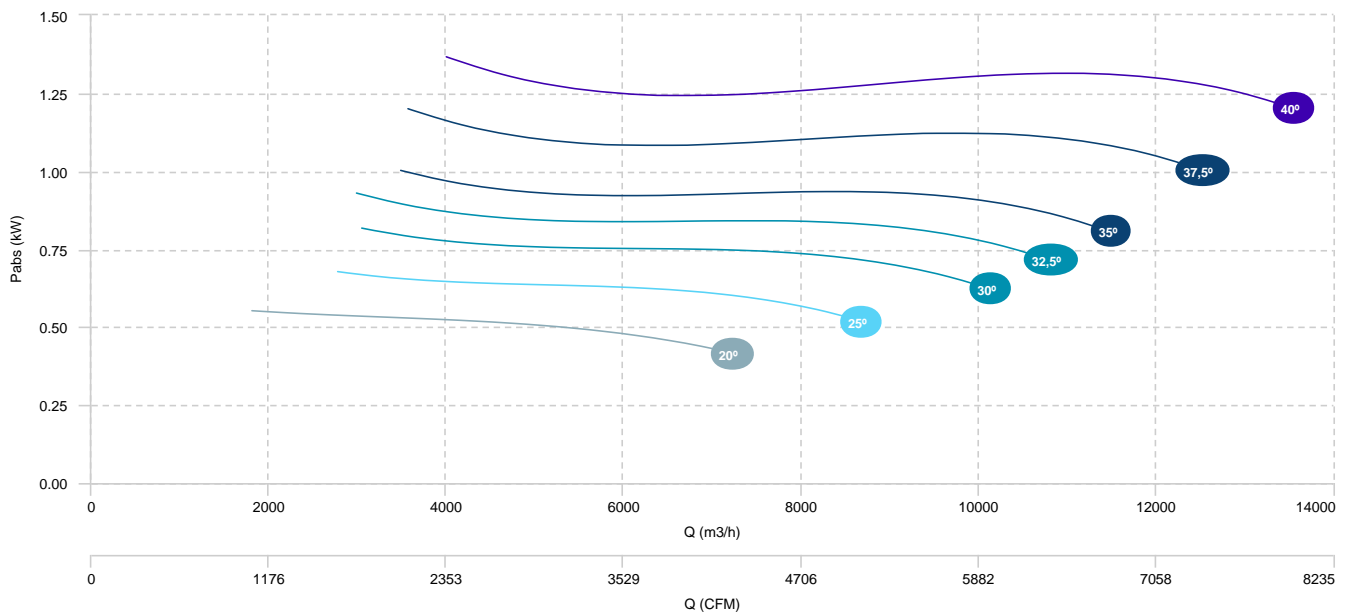

HC 56 T4/T8 0,33/0,04kW (A5:6)	HC 56 T4/T8 0,55/0,09kW (A5:6)	HC 56 T4/T8 0,75/0,12kW (A5:6)
HC 56 T4/T8 1,1/0,18kW (A5:6)	HC 56 T4/T8 1,5/0,25kW (A5:6)	

AIR FLOW - PRESSURE (8 POLES)

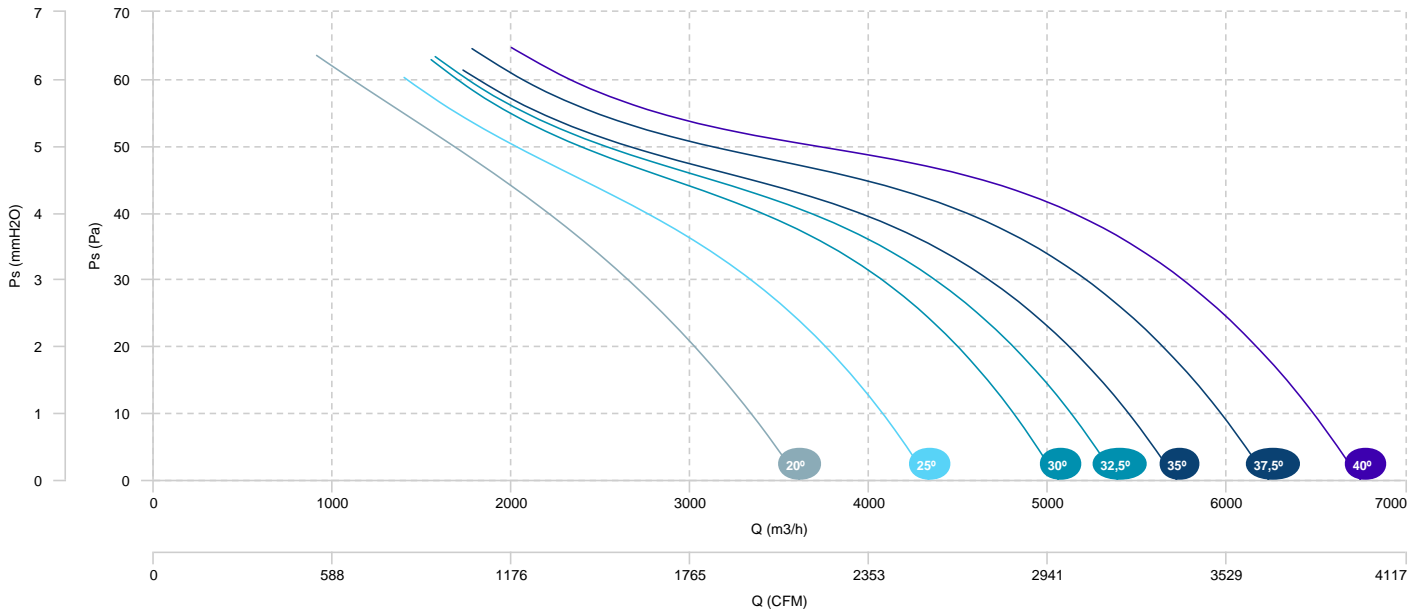

HC 63 T4 0,55kW (A2:6)	HC 63 T4 0,75kW (A2:6)	HC 63 T4 1,1kW (A2:6)
HC 63 T4 1,5kW (A2:6)	HC 63 T4 2,2kW (A2:6)	

AIR FLOW - PRESSURE

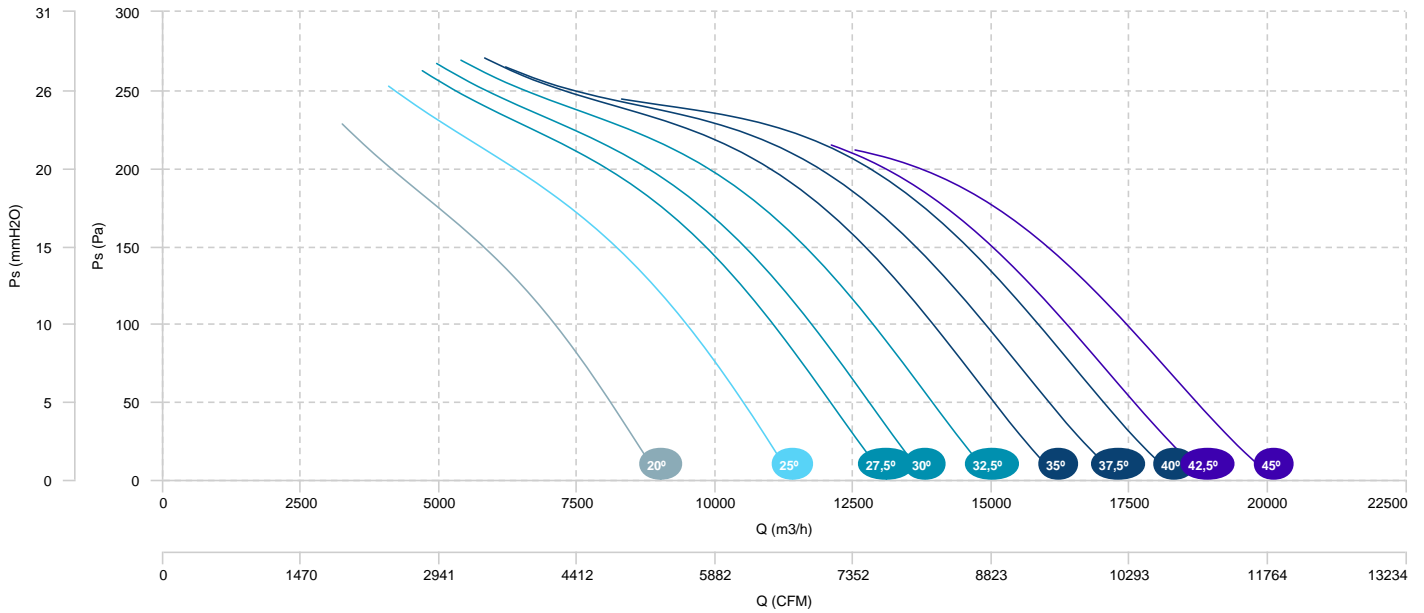

AIR FLOW - ABSORBED POWER

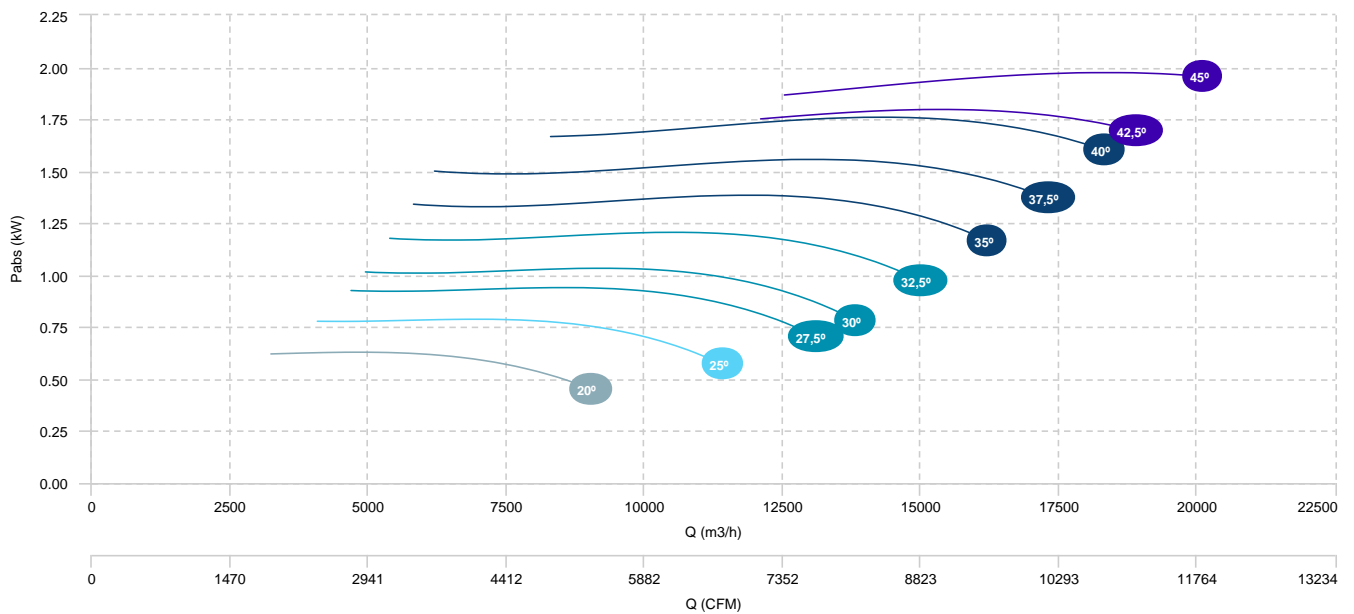

- HC 63 T4 0,75kW (A5:6)
- HC 63 T4 1,1kW (A5:6)
- HC 63 T4 1,5kW (A5:6)
- HC 63 T4 2,2kW (A5:6)

AIR FLOW - PRESSURE

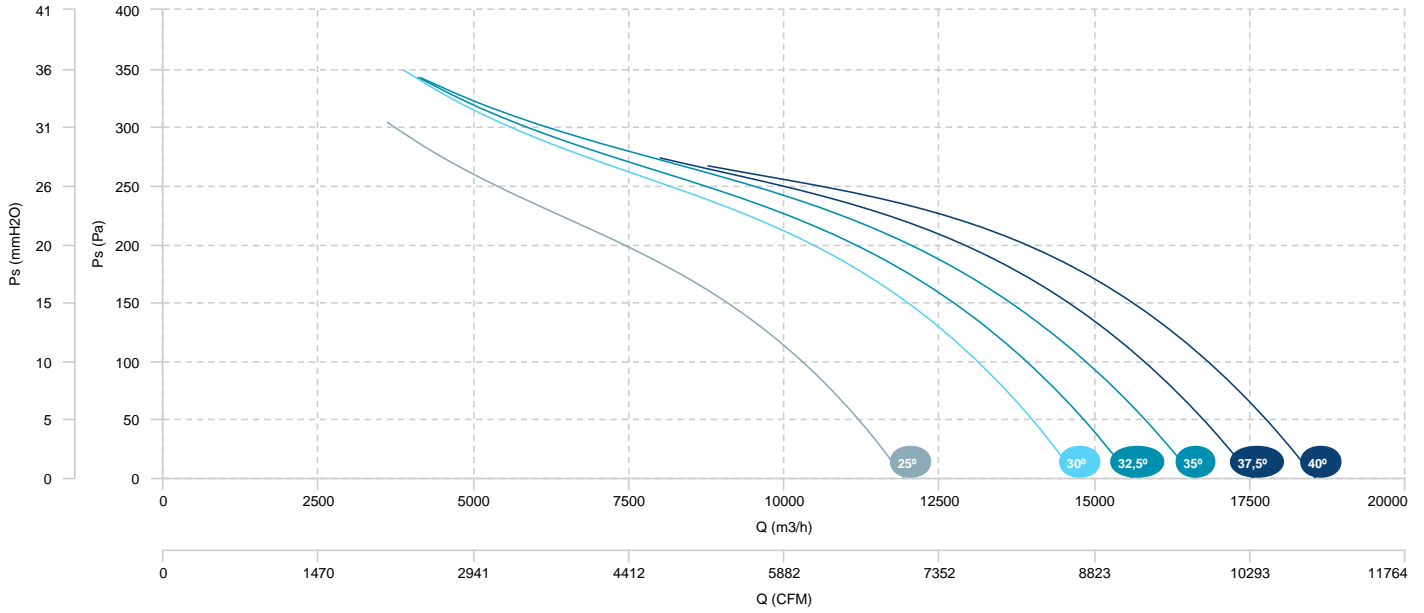

AIR FLOW - ABSORBED POWER

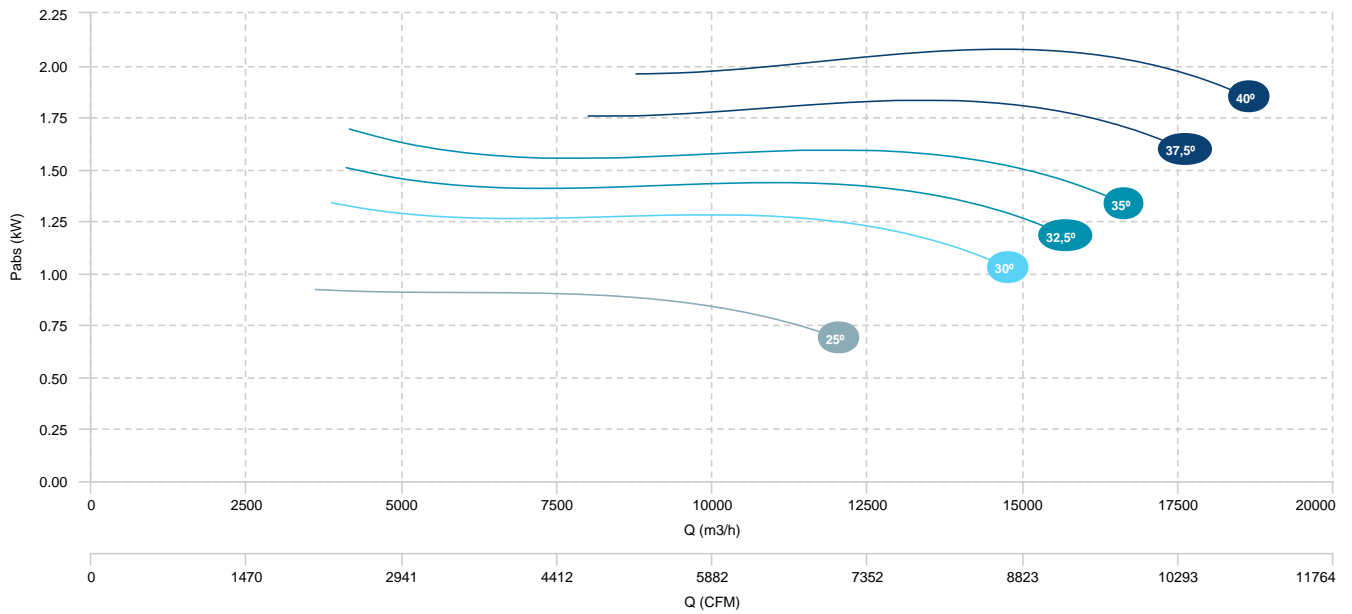

HC 63 T4 0,75kW (A2:9)	HC 63 T4 1,1kW (A2:9)	HC 63 T4 1,5kW (A2:9)
HC 63 T4 2,2kW (A2:9)	HC 63 T4 3kW (A2:9)	

AIR FLOW - PRESSURE

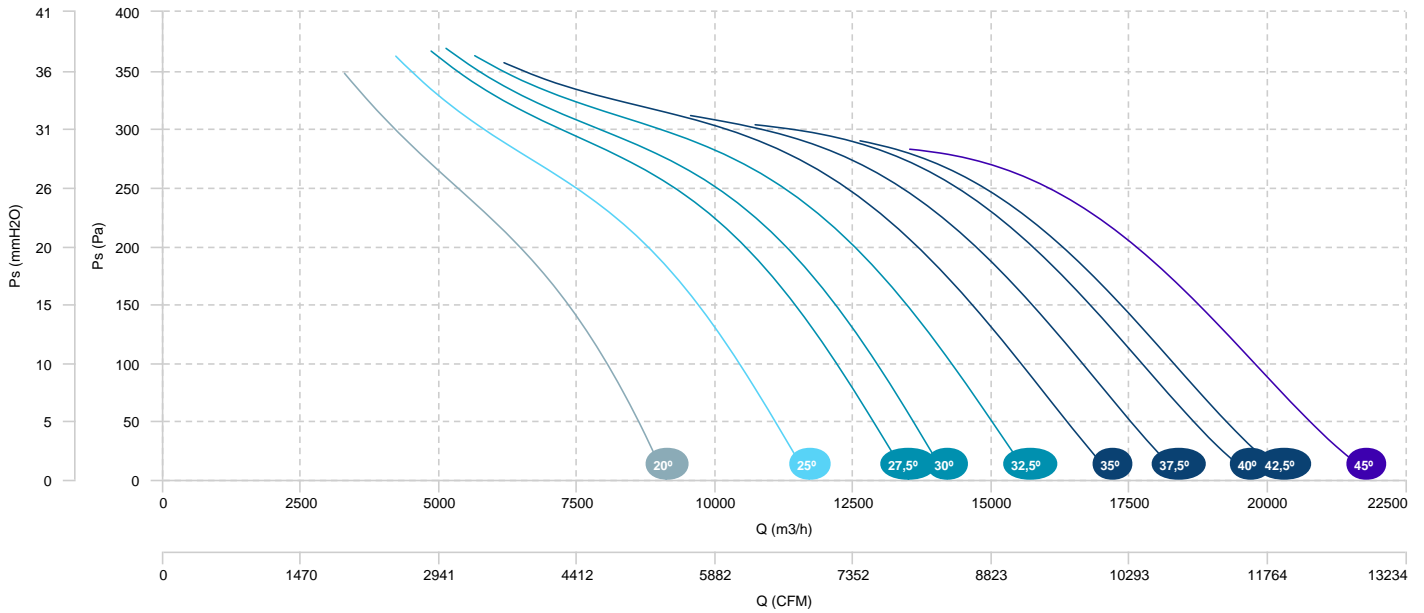

AIR FLOW - ABSORBED POWER

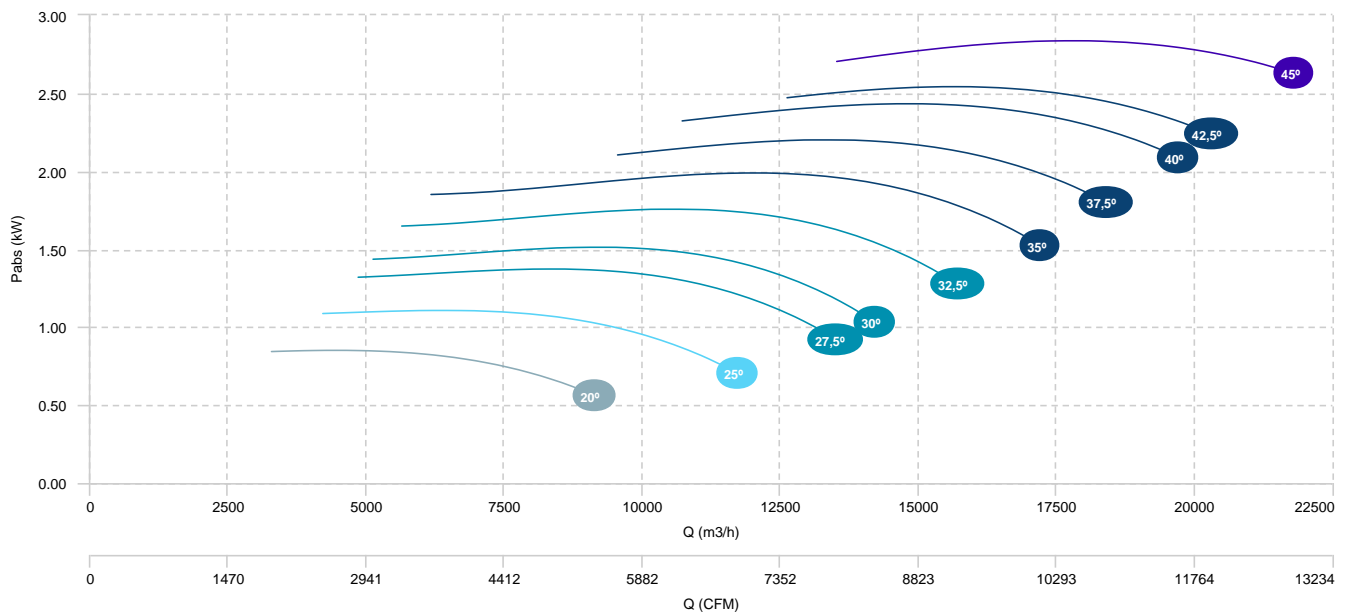

HC 63 T6 0,55KW (A2:6)

AIR FLOW - PRESSURE

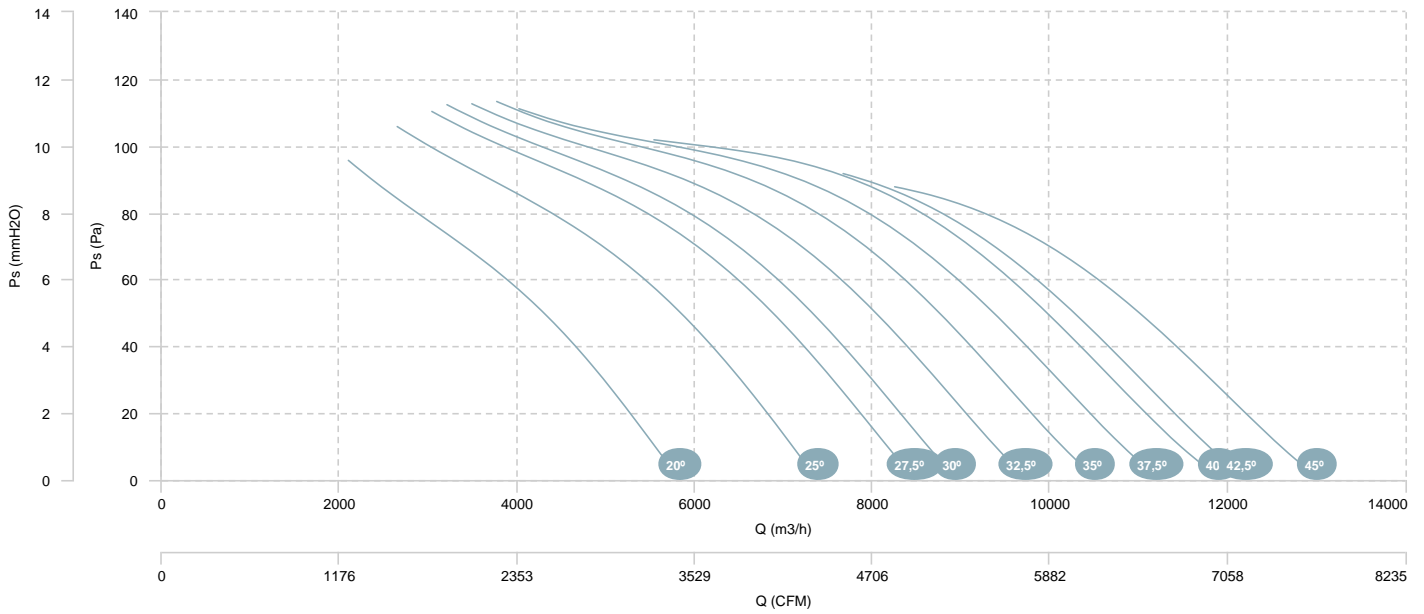

AIR FLOW - ABSORBED POWER



HC 63 T6 0,55kW (A2:9)

HC 63 T6 0,75kW (A2:9)

AIR FLOW - PRESSURE

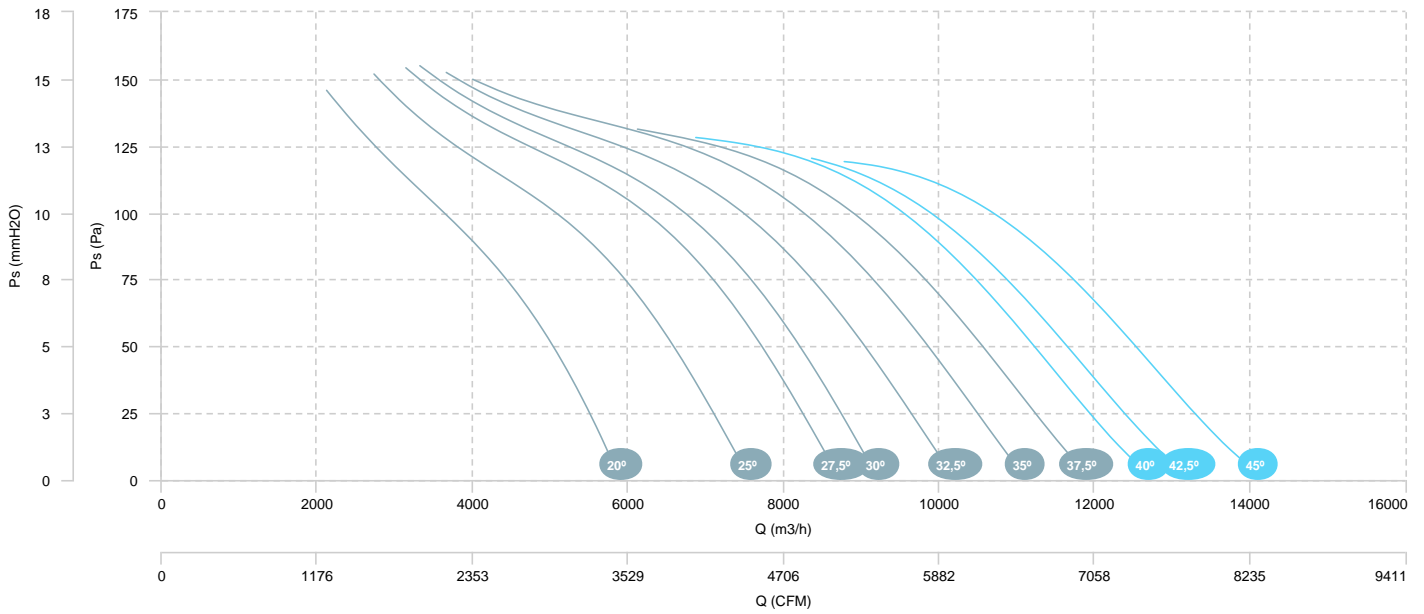

AIR FLOW - ABSORBED POWER

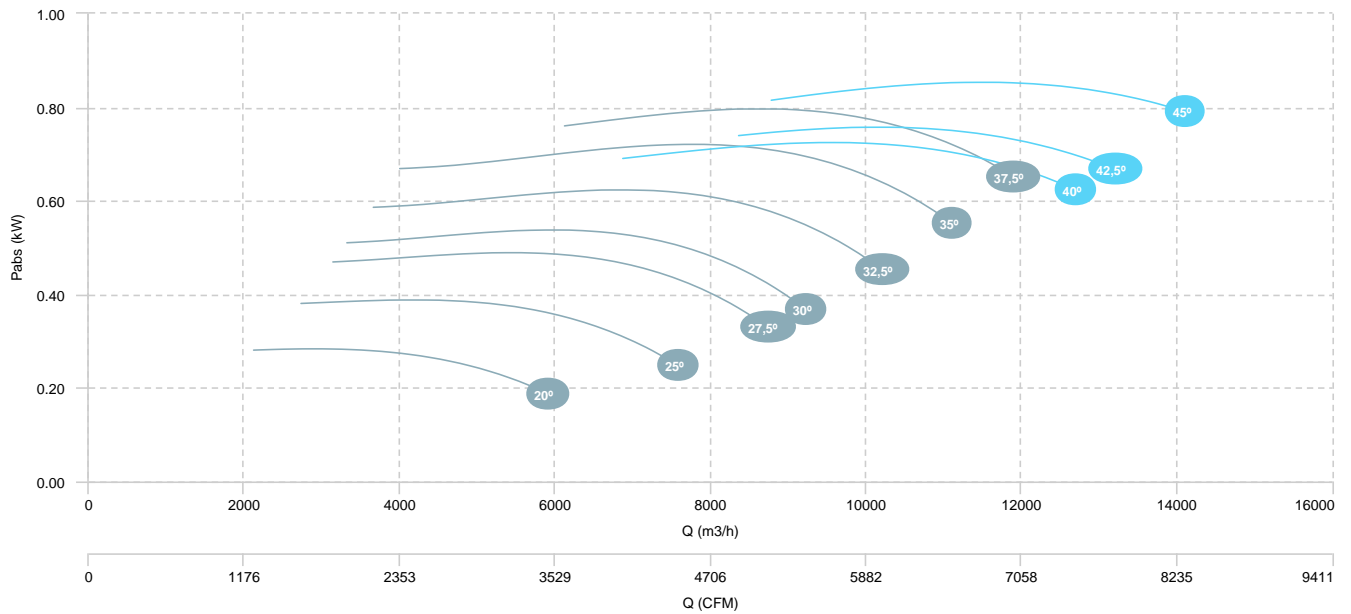

HC 63 T6 0,37kW (A5:6)

HC 63 T6 0,55kW (A5:6)

AIR FLOW - PRESSURE

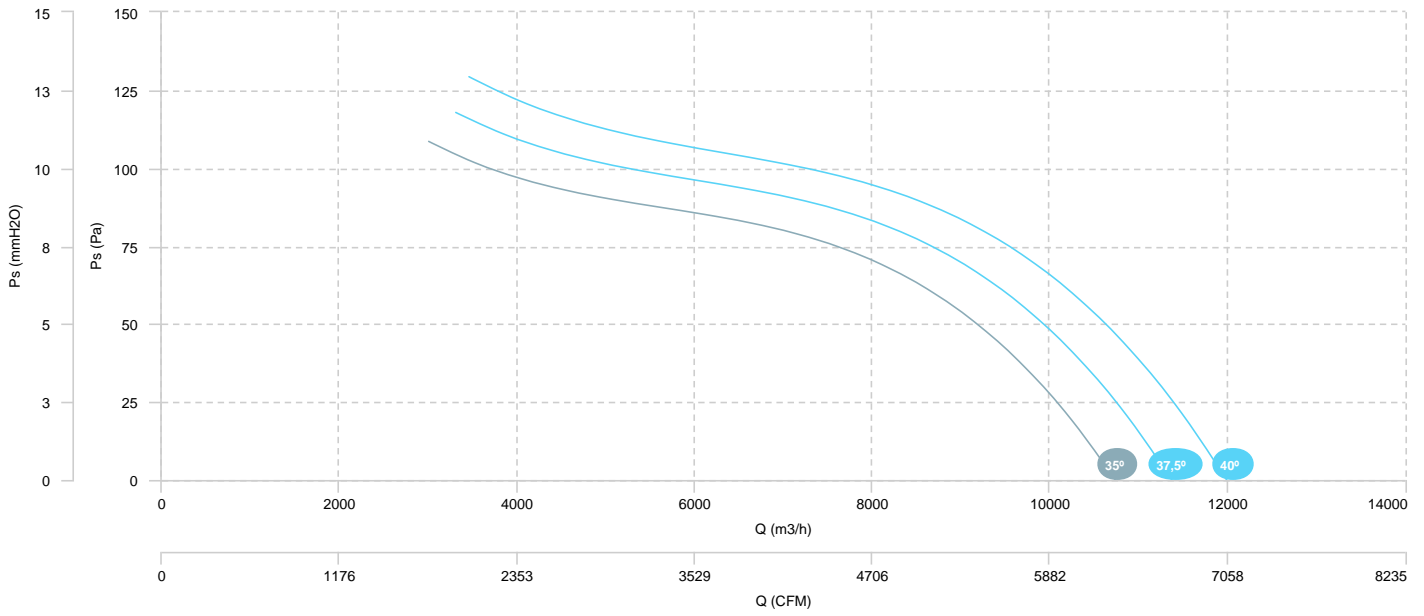

AIR FLOW - ABSORBED POWER

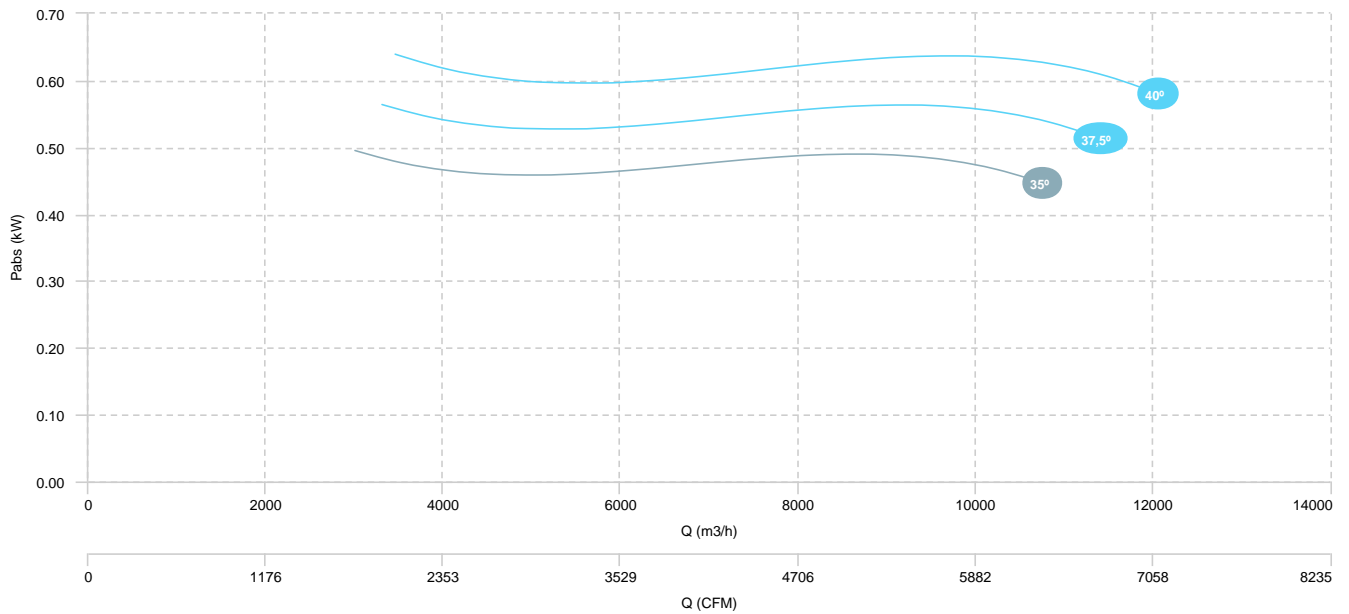

HC 63 T4/T6 0,75/0,25kW (A5:6)	HC 63 T4/T6 1,1/0,37kW (A5:6)	HC 63 T4/T6 1,5/0,5kW (A5:6)
HC 63 T4/T6 2,2/0,6kW (A5:6)		

AIR FLOW - PRESSURE (4 POLES)

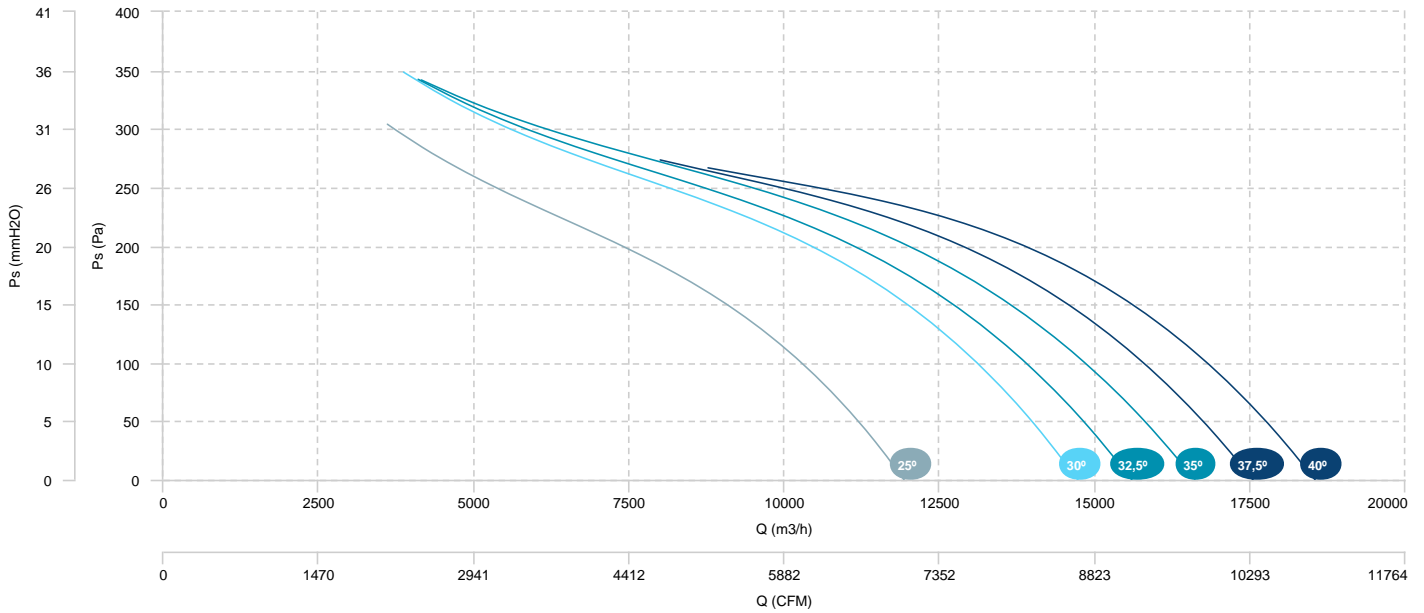

AIR FLOW - ABSORBED POWER (4 POLES)

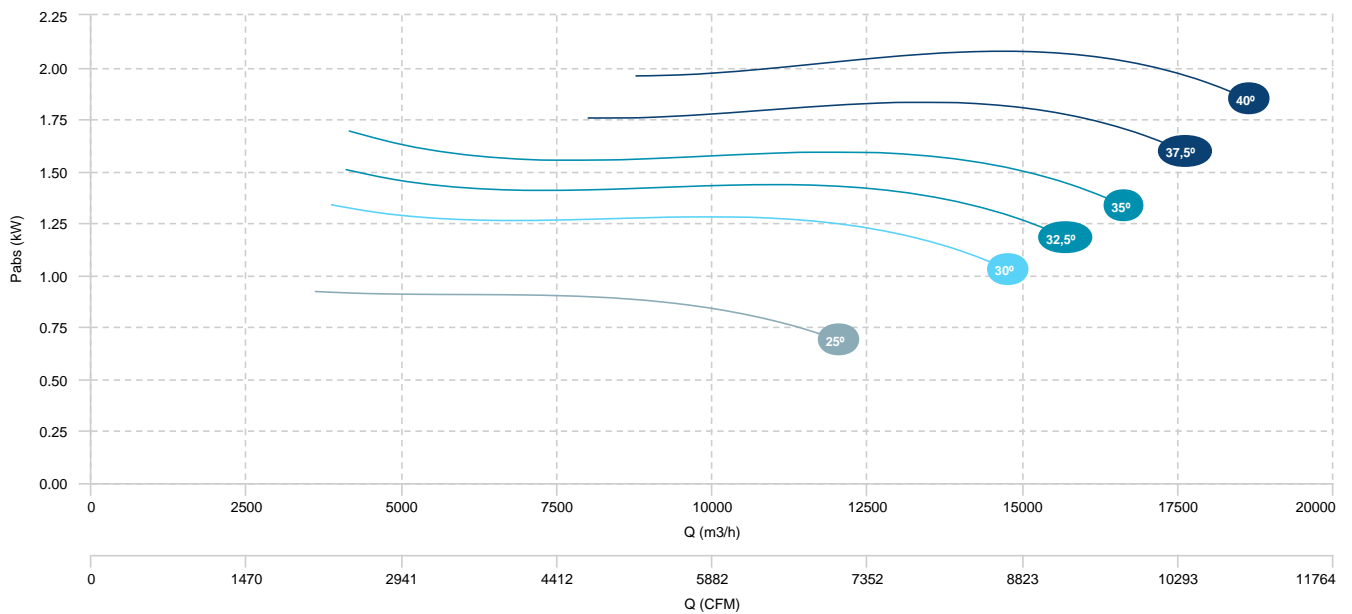

HC 63 T4/T6 0,75/0,25kW (A5:6)	HC 63 T4/T6 1,1/0,37kW (A5:6)	HC 63 T4/T6 1,5/0,5kW (A5:6)
HC 63 T4/T6 2,2/0,6kW (A5:6)		

AIR FLOW - PRESSURE (6 POLES)

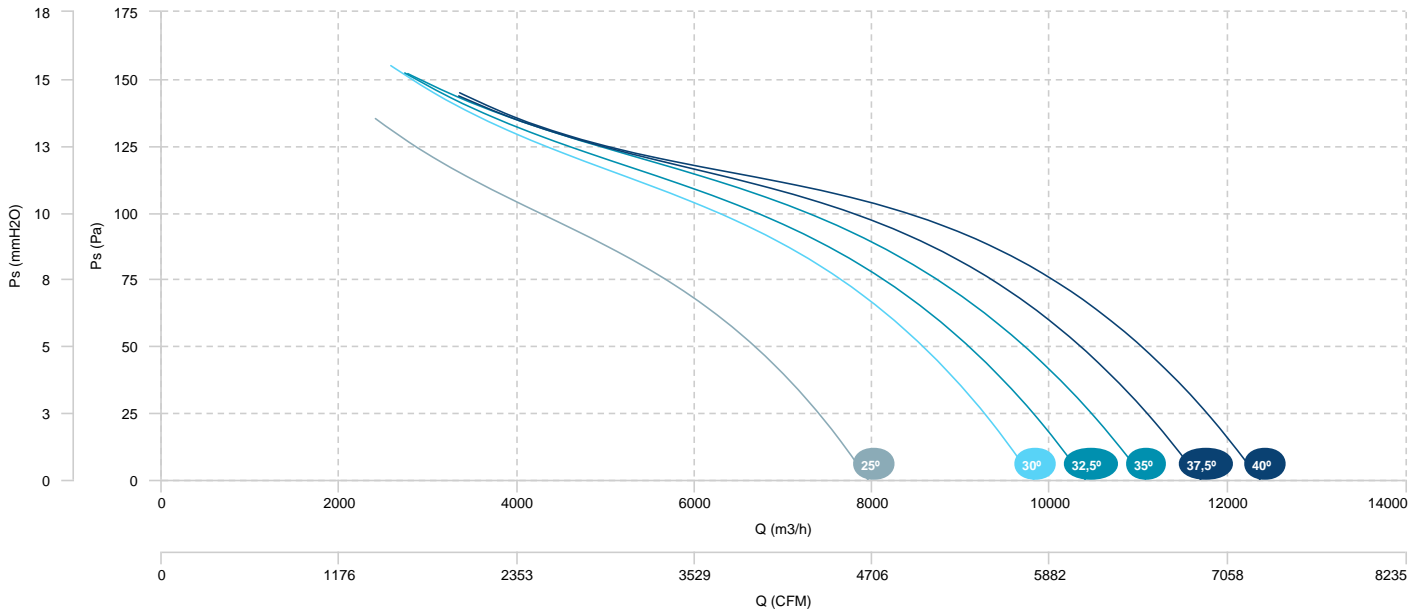

HC 63 T4/T6 0,75/0,25kW (A2:9)	HC 63 T4/T6 1,1/0,37kW (A2:9)	HC 63 T4/T6 1,5/0,5kW (A2:9)
HC 63 T4/T6 2,2/0,6kW (A2:9)	HC 63 T4/T6 3/0,9kW (A2:9)	

AIR FLOW - PRESSURE (4 POLES)

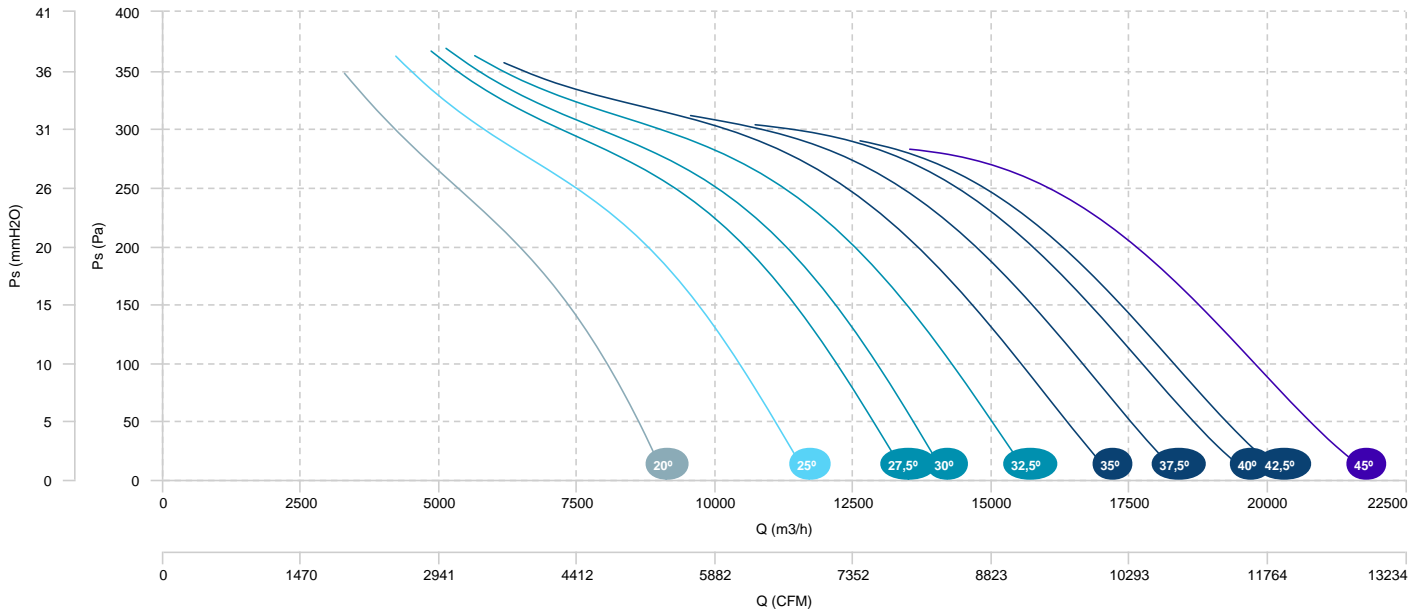

AIR FLOW - ABSORBED POWER (4 POLES)

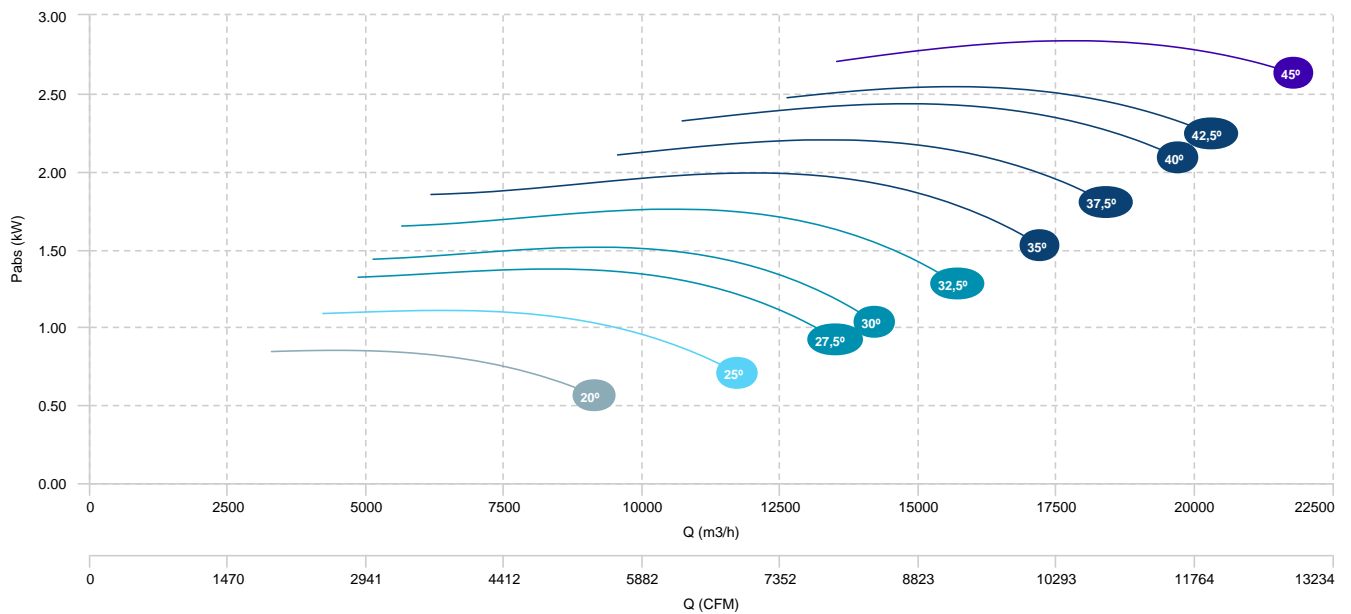

HC 63 T4/T6 0,75/0,25kW (A2:9)	HC 63 T4/T6 1,1/0,37kW (A2:9)	HC 63 T4/T6 1,5/0,5kW (A2:9)
HC 63 T4/T6 2,2/0,6kW (A2:9)	HC 63 T4/T6 3/0,9kW (A2:9)	

AIR FLOW - PRESSURE (6 POLES)

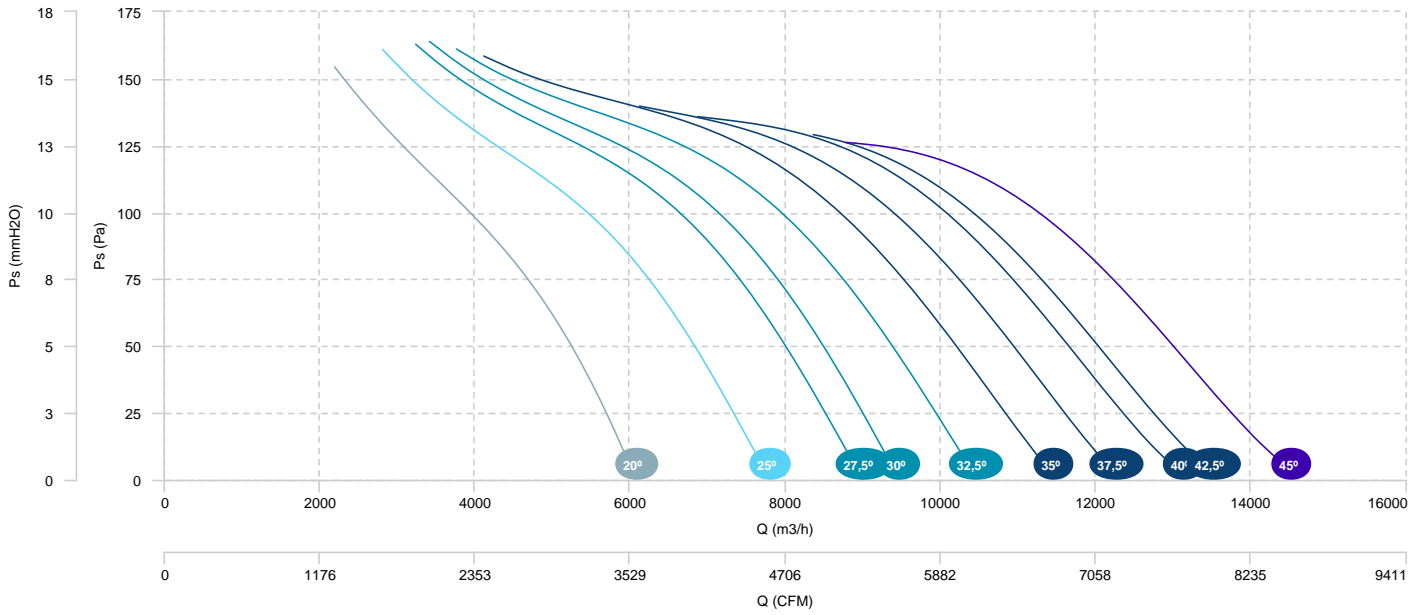

HC 63 T4/T6 0,55/0,18kW (A2:6)	HC 63 T4/T6 0,75/0,25kW (A2:6)	HC 63 T4/T6 1,1/0,37kW (A2:6)
HC 63 T4/T6 1,5/0,5kW (A2:6)	HC 63 T4/T6 2,2/0,6kW (A2:6)	

AIR FLOW - PRESSURE (4 POLES)

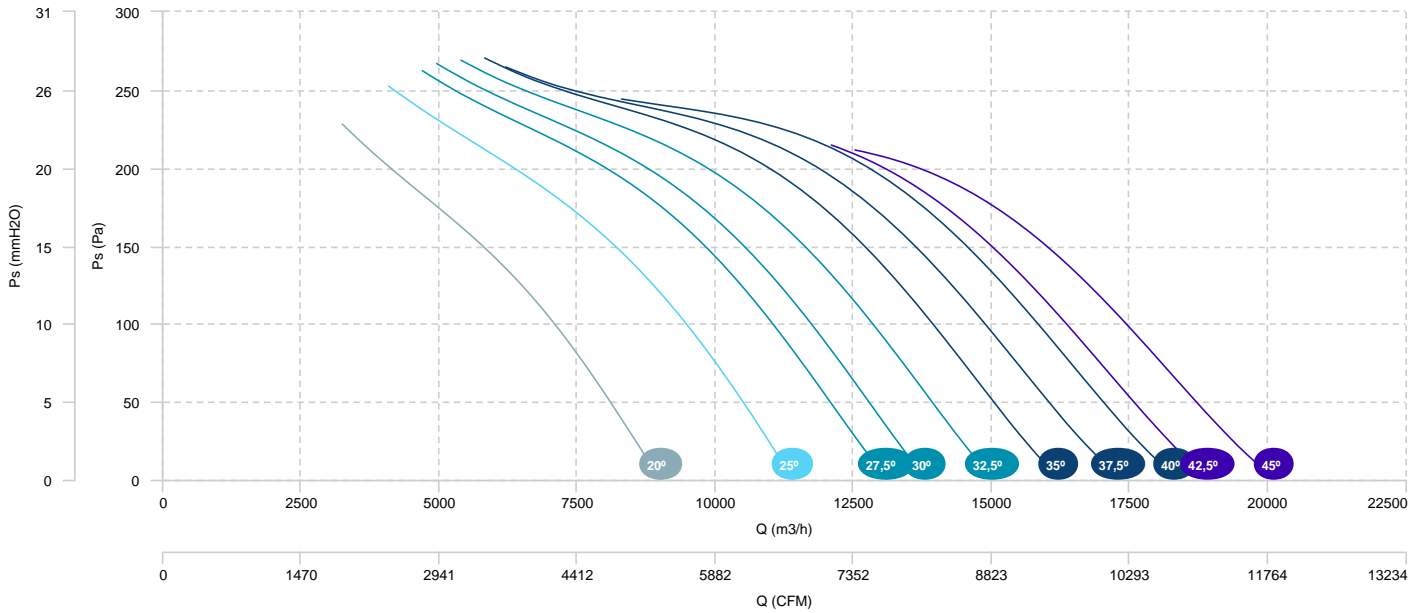

AIR FLOW - ABSORBED POWER (4 POLES)

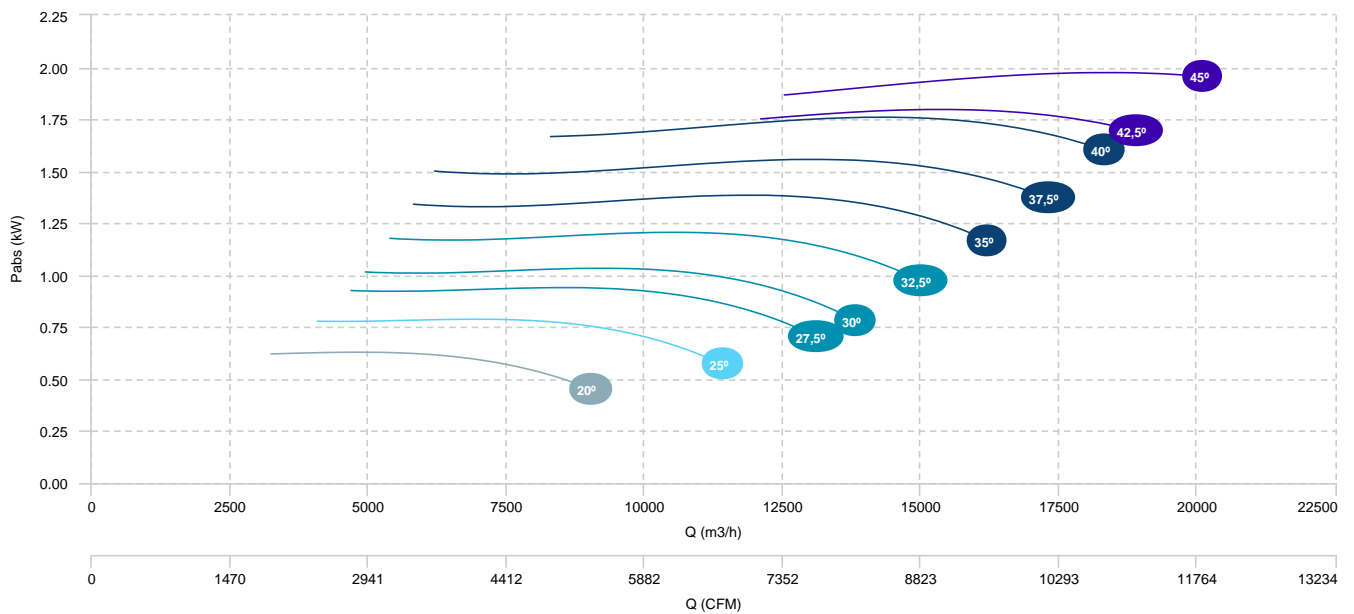

HC 63 T4/T6 0,55/0,18kW (A2:6)	HC 63 T4/T6 0,75/0,25kW (A2:6)	HC 63 T4/T6 1,1/0,37kW (A2:6)
HC 63 T4/T6 1,5/0,5kW (A2:6)	HC 63 T4/T6 2,2/0,6kW (A2:6)	

AIR FLOW - PRESSURE (6 POLES)

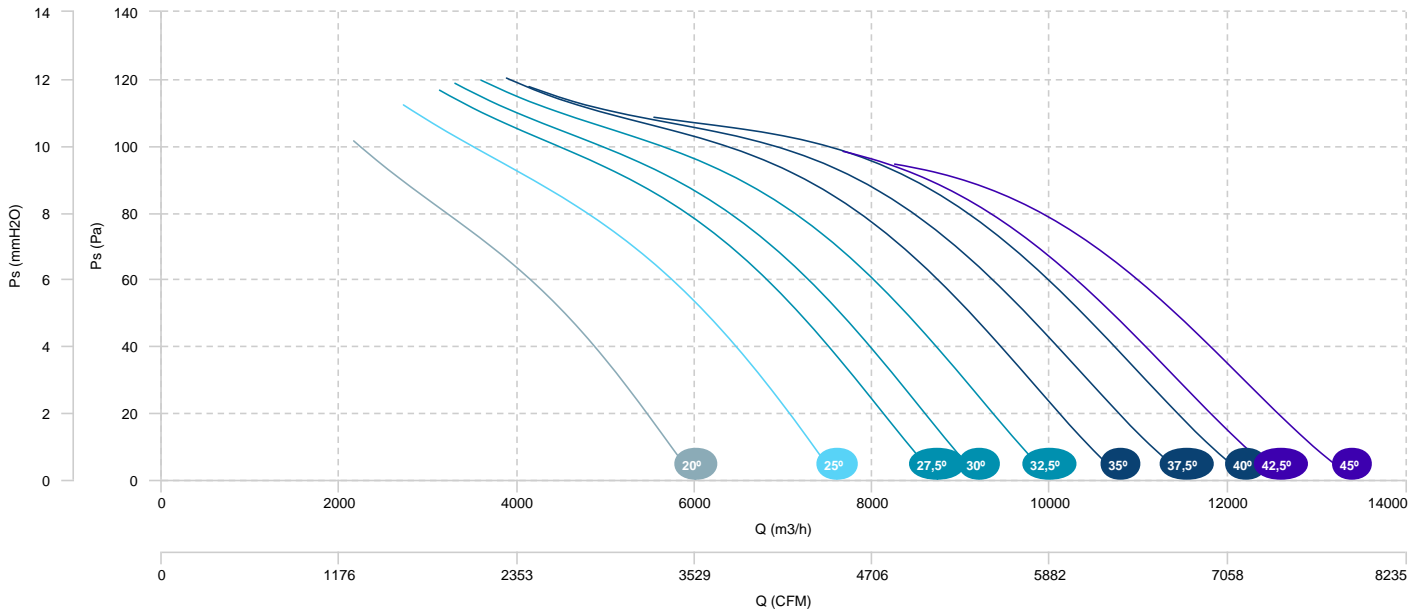

HC 63 T4/T8 0,75/0,12kW (A2:9)	HC 63 T4/T8 1,1/0,18kW (A2:9)	HC 63 T4/T8 1,5/0,25kW (A2:9)
HC 63 T4/T8 2,2/0,37kW (A2:9)	HC 63 T4/T8 3/0,55kW (A2:9)	

AIR FLOW - PRESSURE (4 POLES)

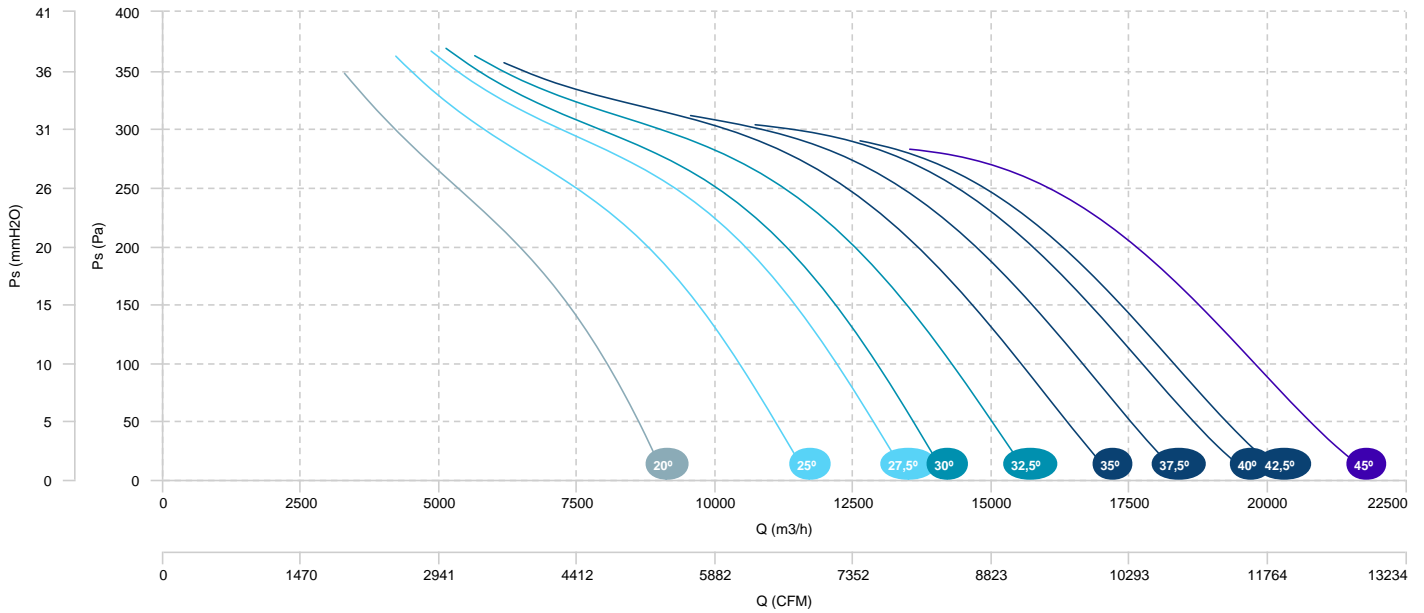

AIR FLOW - ABSORBED POWER (4 POLES)

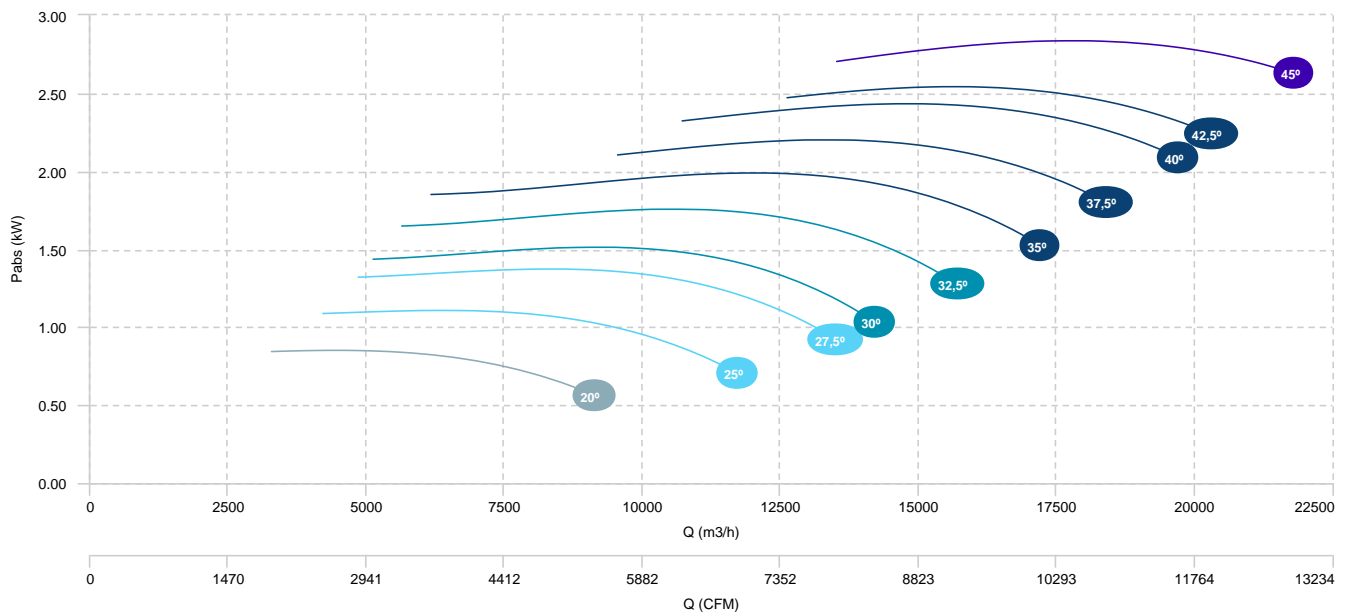

HC 63 T4/T8 0,75/0,12kW (A2:9)	HC 63 T4/T8 1,1/0,18kW (A2:9)	HC 63 T4/T8 1,5/0,25kW (A2:9)
HC 63 T4/T8 2,2/0,37kW (A2:9)	HC 63 T4/T8 3/0,55kW (A2:9)	

AIR FLOW - PRESSURE (8 POLES)

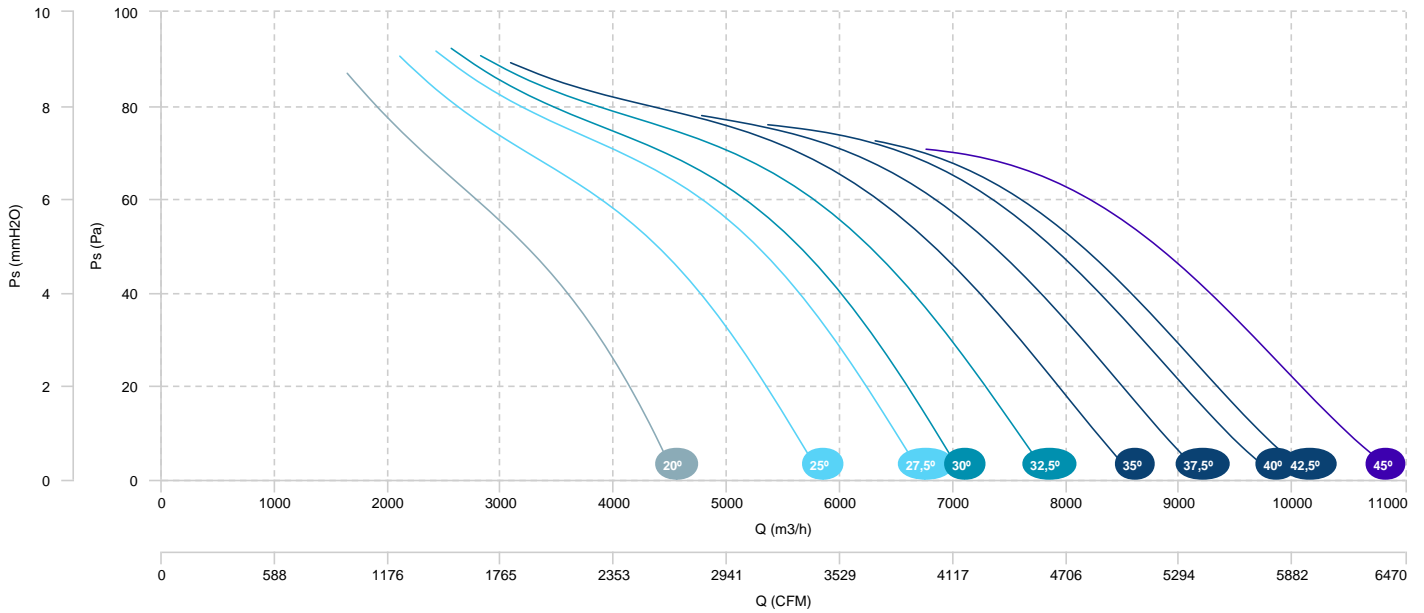

HC 63 T4/T8 0,75/0,12kW (A5:6)
 HC 63 T4/T8 2,2/0,37kW (A5:6)

HC 63 T4/T8 1,1/0,18kW (A5:6)

HC 63 T4/T8 1,5/0,25kW (A5:6)

AIR FLOW - PRESSURE (4 POLES)

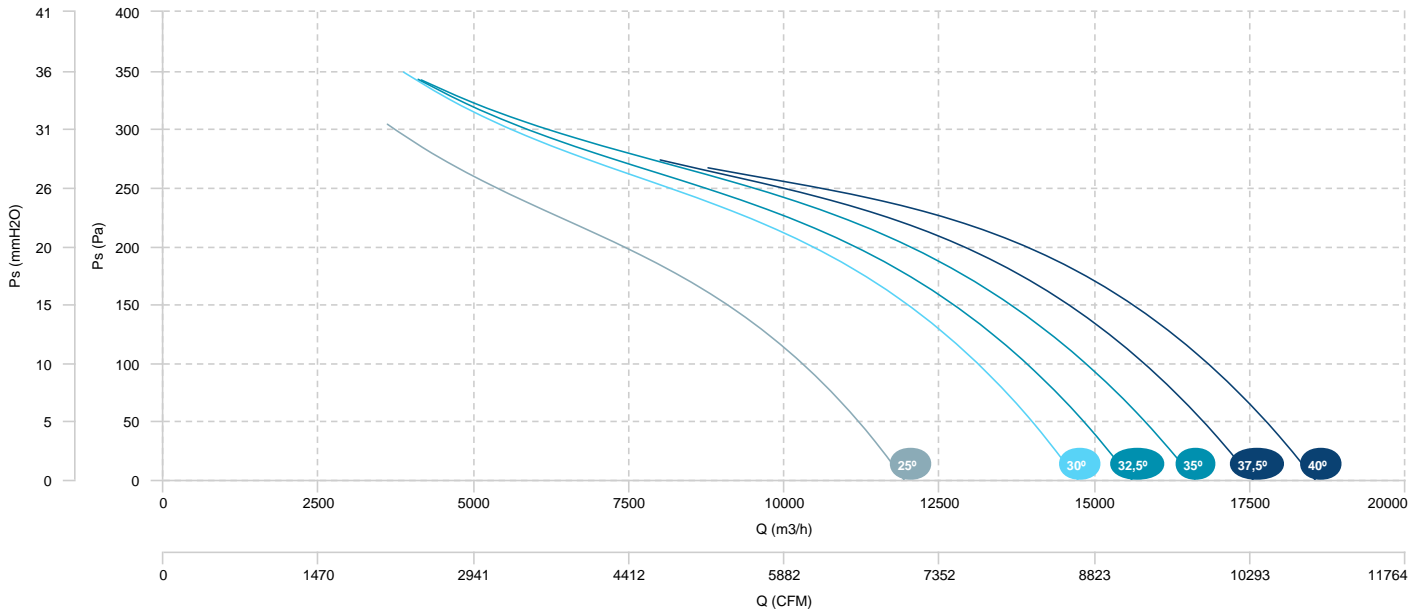

AIR FLOW - ABSORBED POWER (4 POLES)

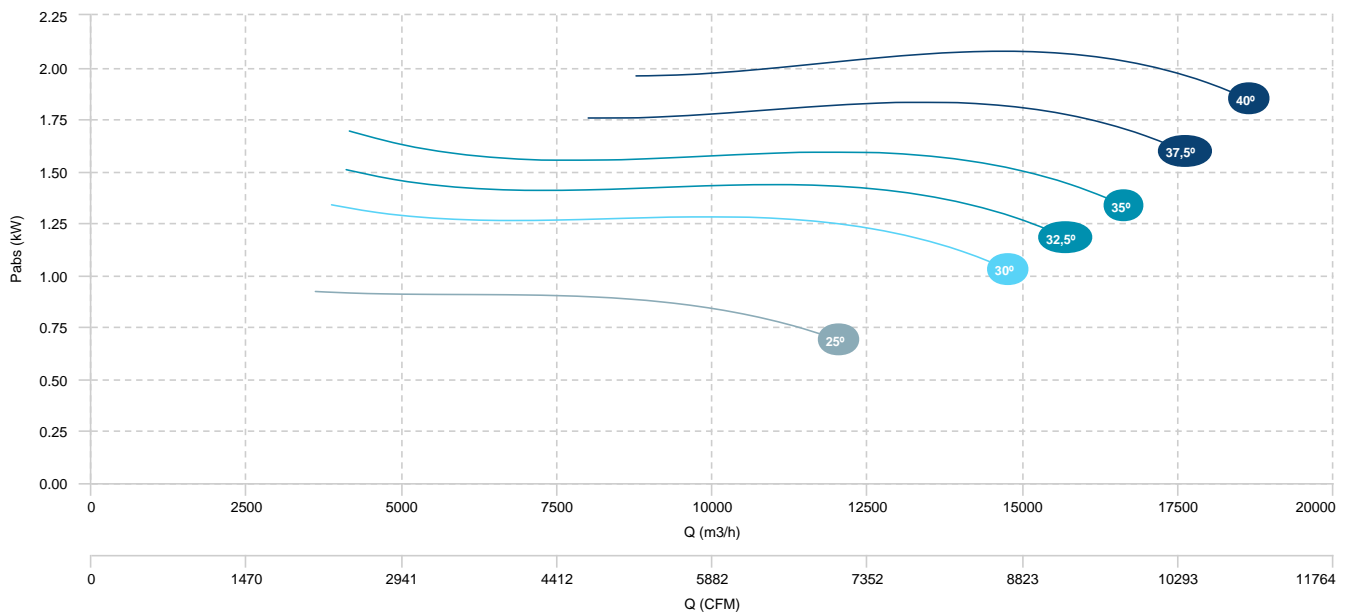

HC 63 T4/T8 0,75/0,12kW (A5:6)	HC 63 T4/T8 1,1/0,18kW (A5:6)	HC 63 T4/T8 1,5/0,25kW (A5:6)
HC 63 T4/T8 2,2/0,37kW (A5:6)		

AIR FLOW - PRESSURE (8 POLES)

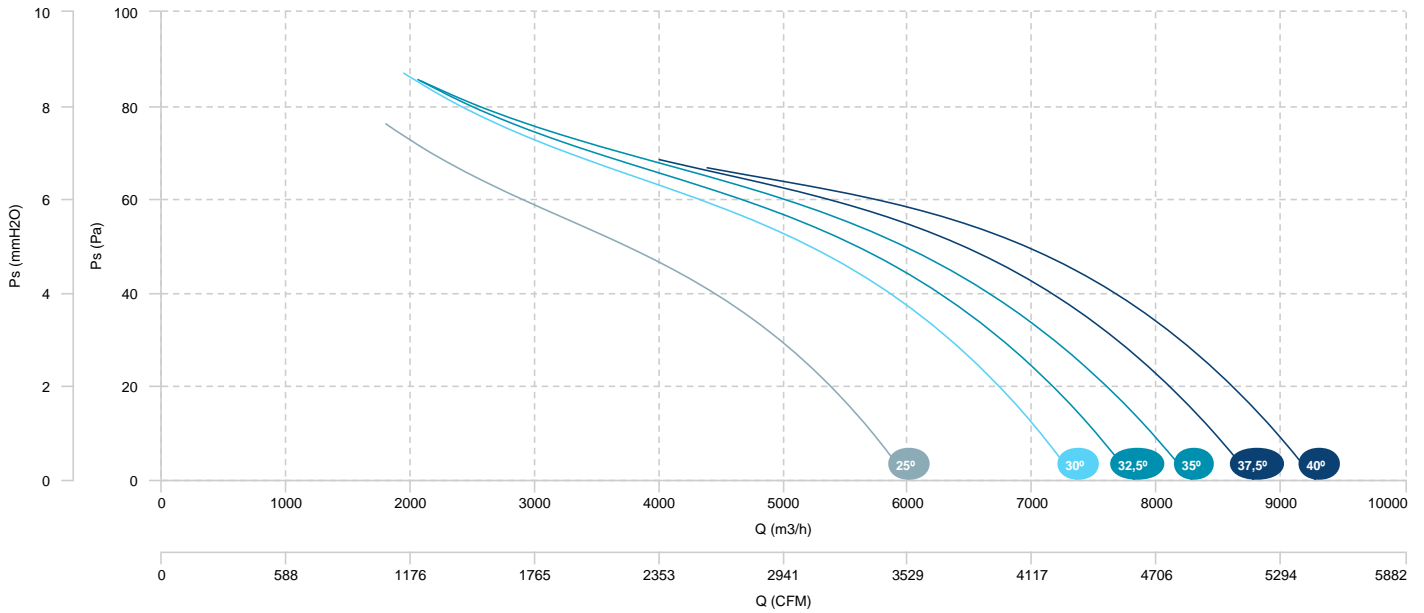

HC 63 T4/T8 0,55/0,09kW (A2:6)	HC 63 T4/T8 0,75/0,12kW (A2:6)	HC 63 T4/T8 1,1/0,18kW (A2:6)
HC 63 T4/T8 1,5/0,25kW (A2:6)	HC 63 T4/T8 2,2/0,37kW (A2:6)	

AIR FLOW - PRESSURE (4 POLES)

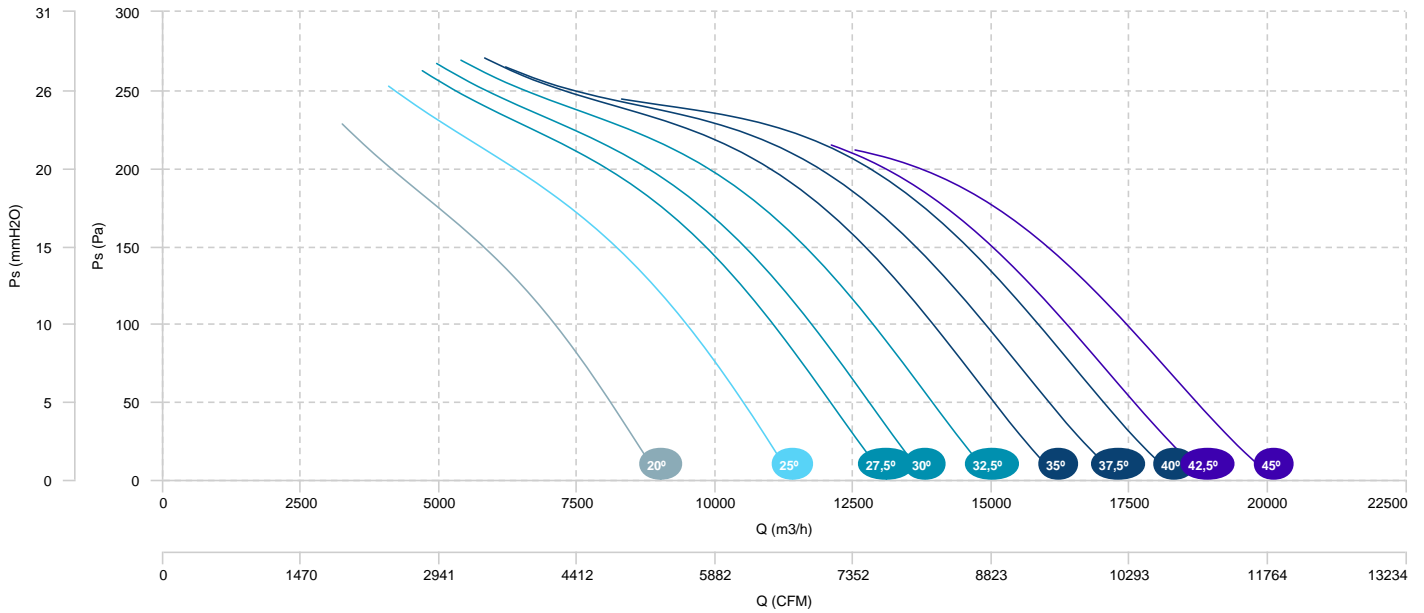

AIR FLOW - ABSORBED POWER (4 POLES)

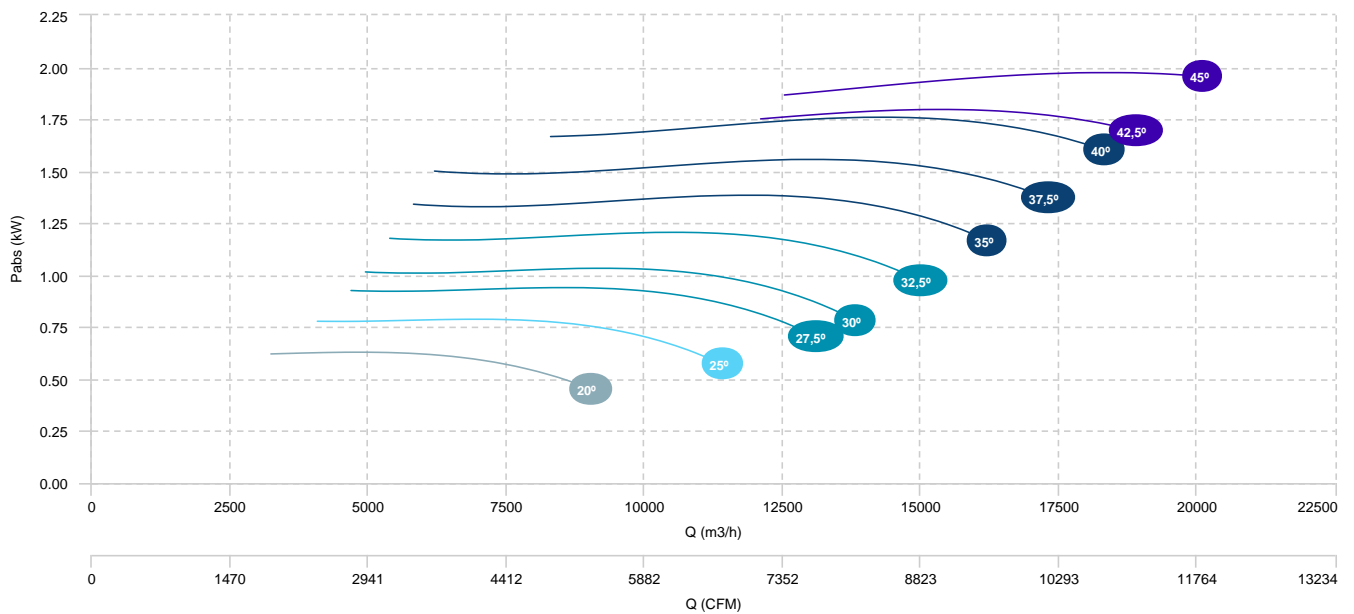

HC 63 T4/T8 0,55/0,09kW (A2:6)	HC 63 T4/T8 0,75/0,12kW (A2:6)	HC 63 T4/T8 1,1/0,18kW (A2:6)
HC 63 T4/T8 1,5/0,25kW (A2:6)	HC 63 T4/T8 2,2/0,37kW (A2:6)	

AIR FLOW - PRESSURE (8 POLES)

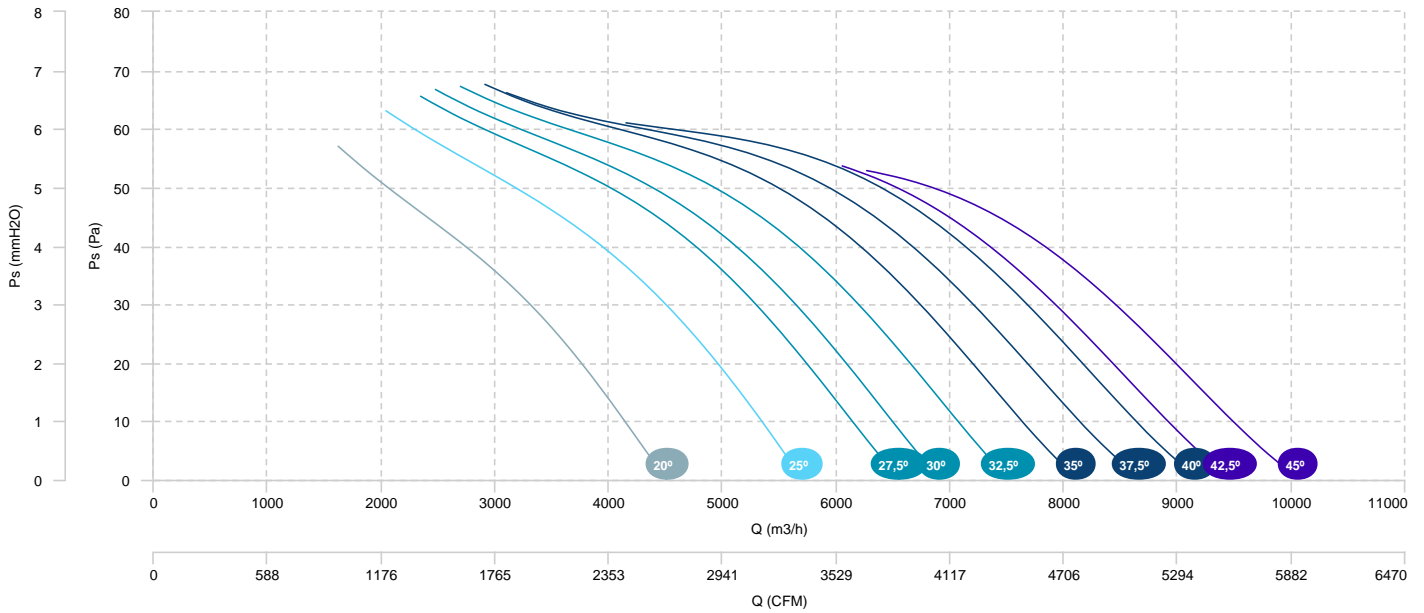

HC 71 T4 0,75kW (A2:6)	HC 71 T4 1,1kW (A2:6)	HC 71 T4 1,5kW (A2:6)
HC 71 T4 2,2kW (A2:6)	HC 71 T4 3kW (A2:6)	

AIR FLOW - PRESSURE

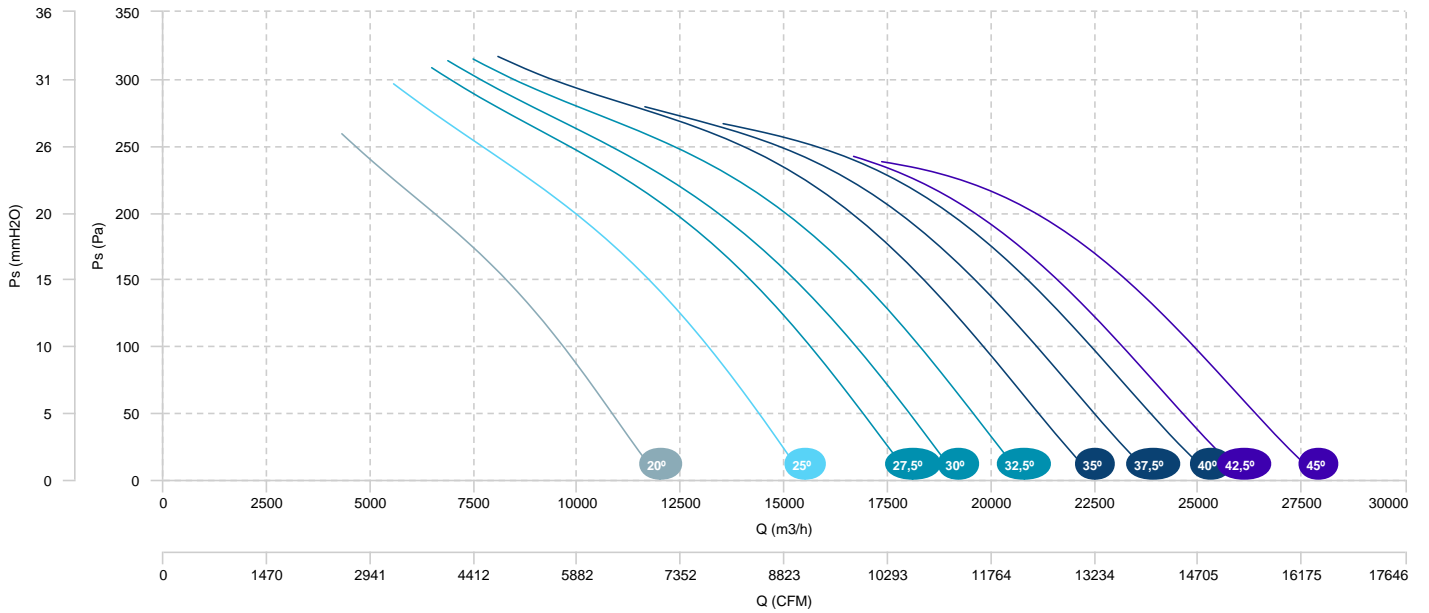

AIR FLOW - ABSORBED POWER

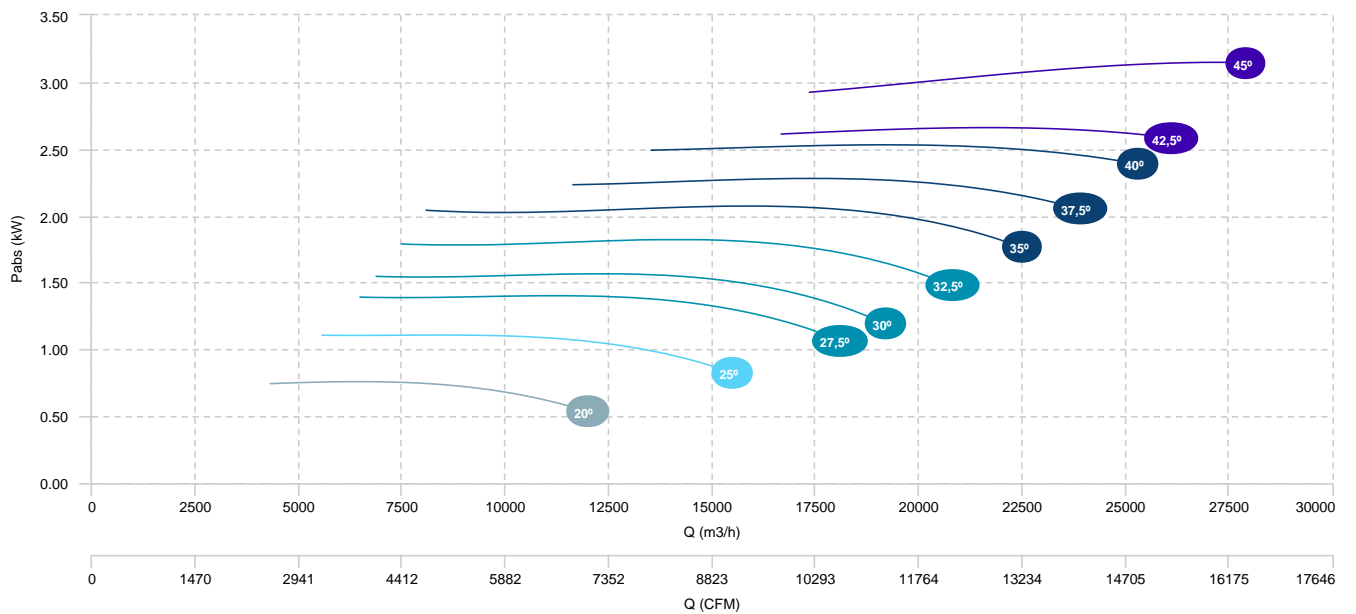

HC 71 T4 1,1kW (A2:9)	HC 71 T4 1,5kW (A2:9)	HC 71 T4 2,2kW (A2:9)
HC 71 T4 3kW (A2:9)		

AIR FLOW - PRESSURE

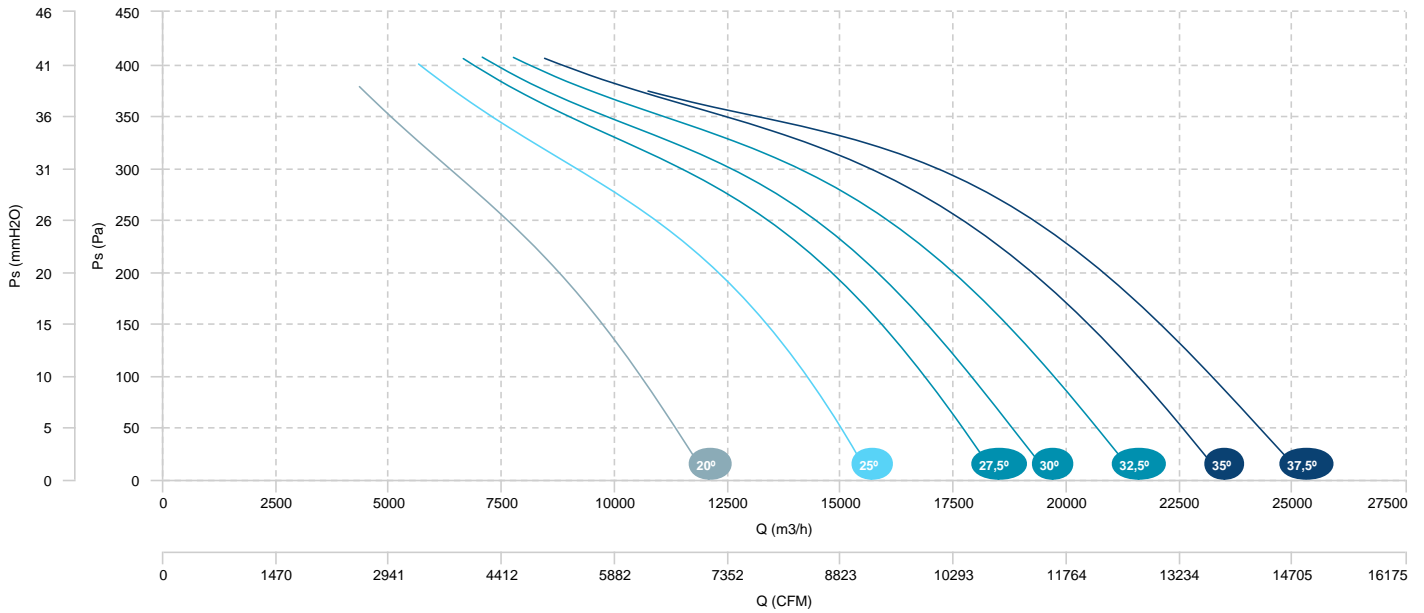

AIR FLOW - ABSORBED POWER

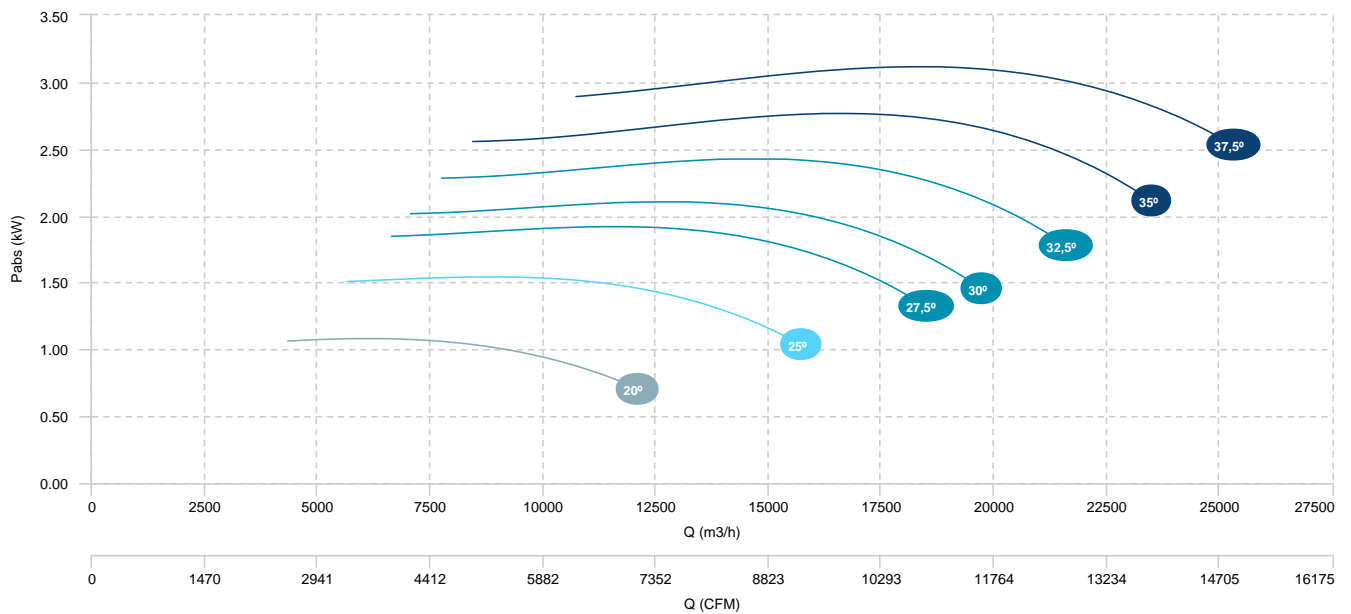

HC 71 T4 0,75kW (A5:6)	HC 71 T4 1,1kW (A5:6)	HC 71 T4 1,5kW (A5:6)
HC 71 T4 2,2kW (A5:6)	HC 71 T4 3kW (A5:6)	

AIR FLOW - PRESSURE

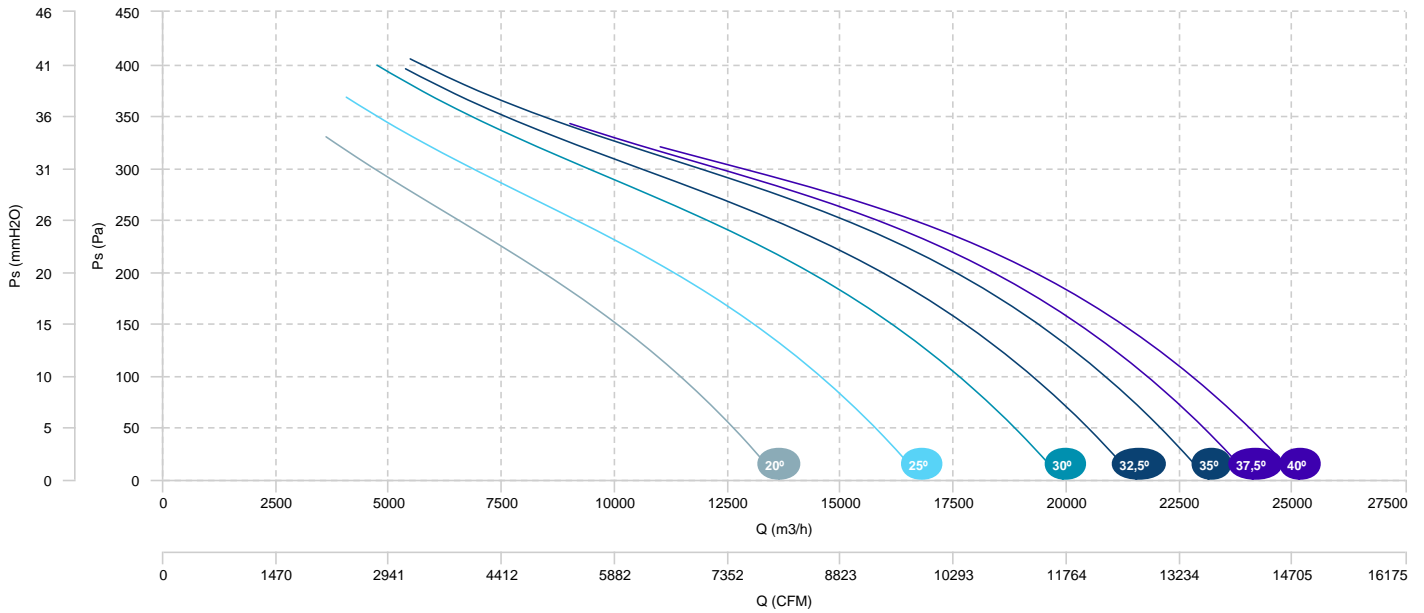

AIR FLOW - ABSORBED POWER

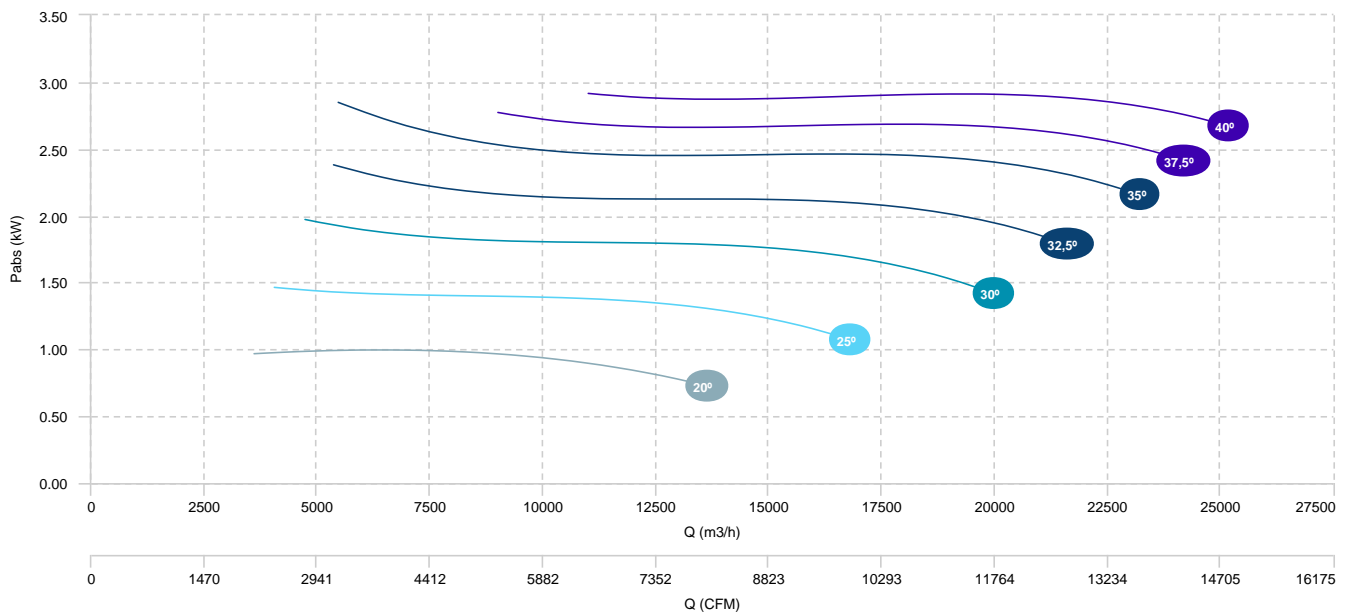

HC 71 T6 0,75kW (A5:6)

AIR FLOW - PRESSURE

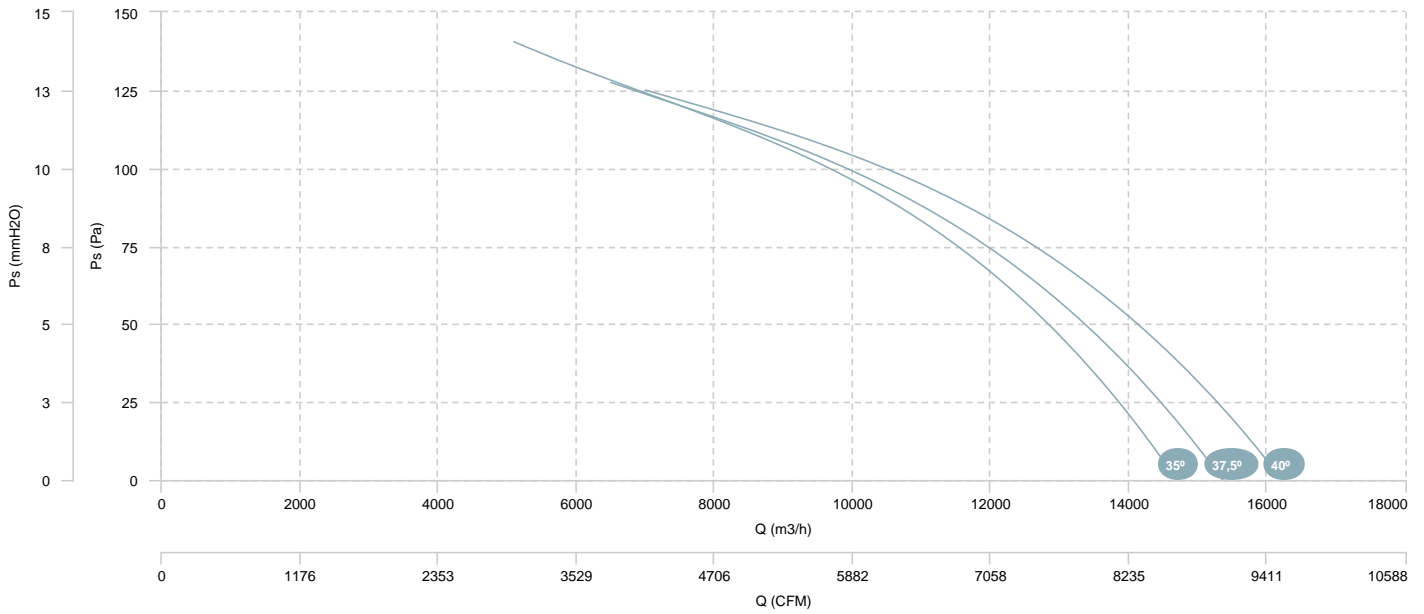

AIR FLOW - ABSORBED POWER

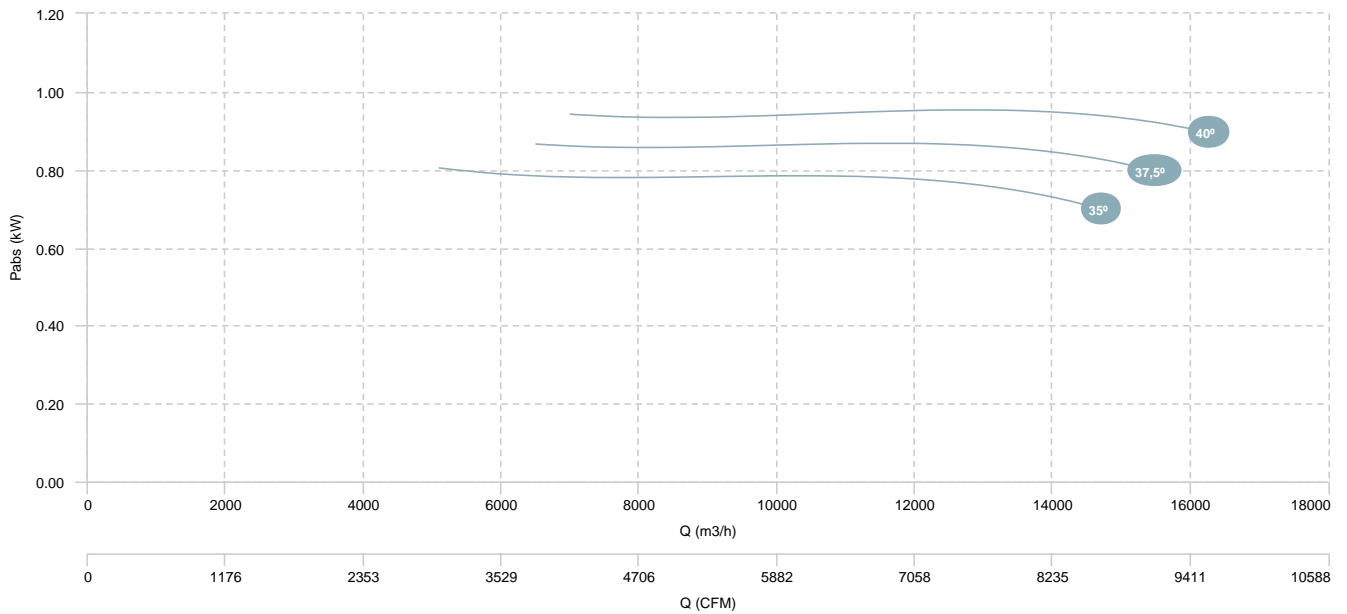

HC 71 T6 0,55kW (A2:9)

HC 71 T6 0,75kW (A2:9)

HC 71 T6 1,1kW (A2:9)

AIR FLOW - PRESSURE

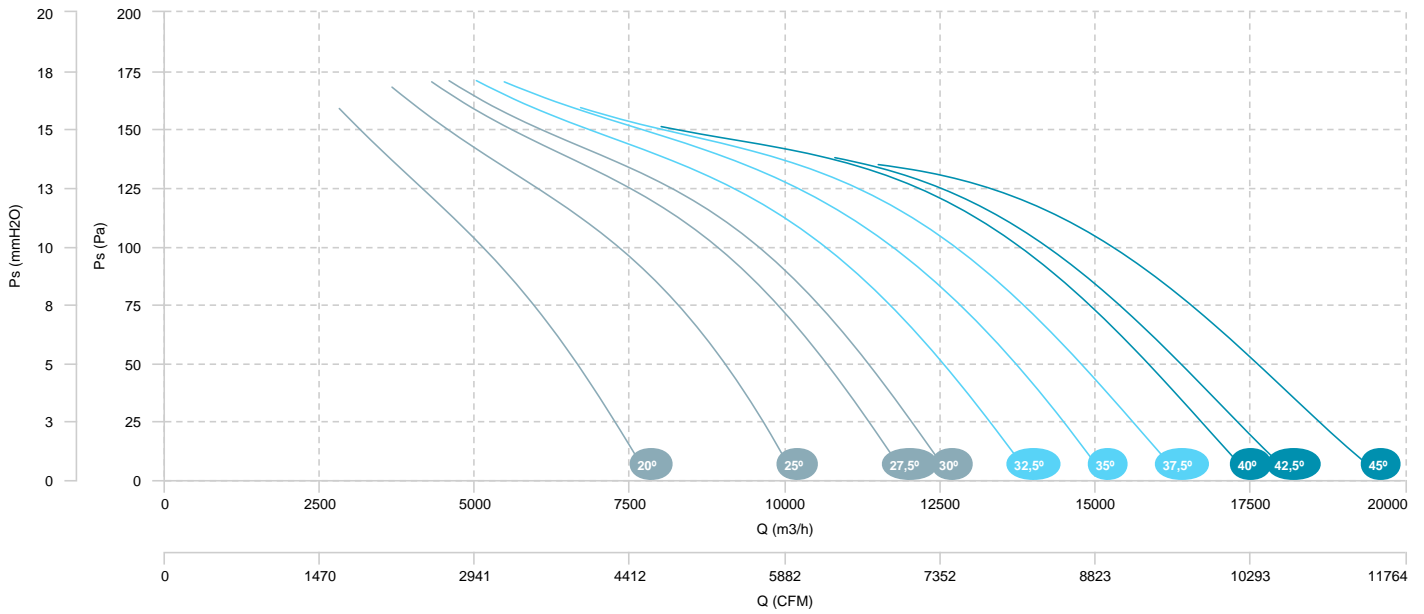

AIR FLOW - ABSORBED POWER

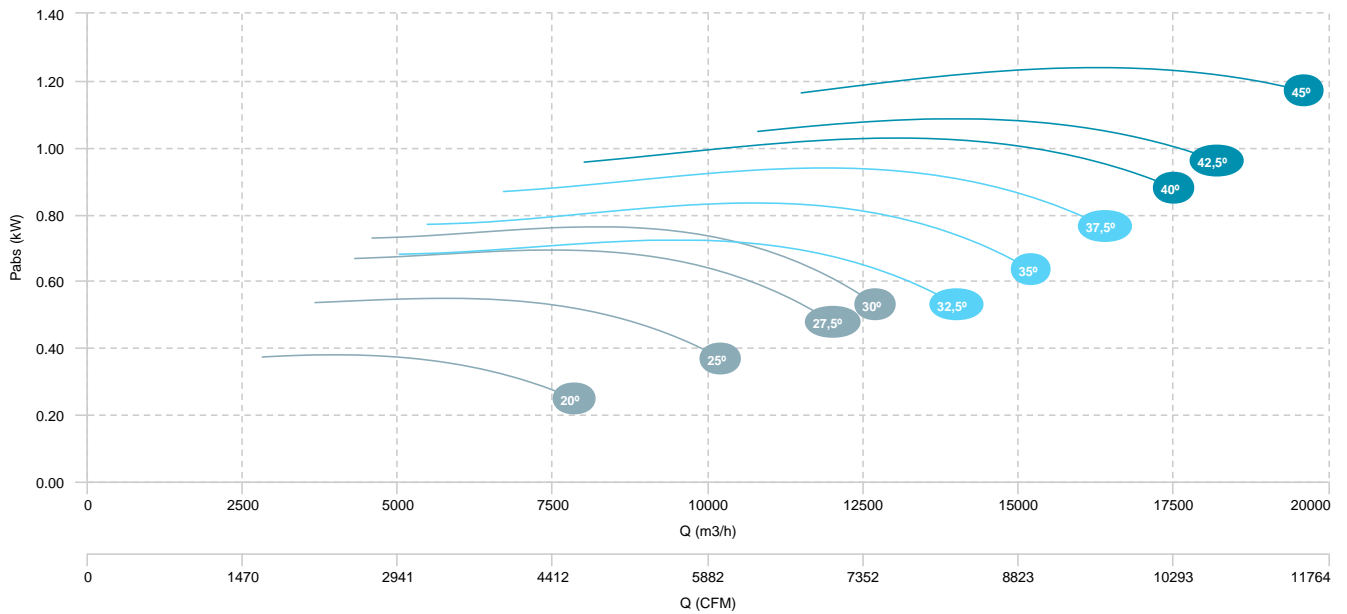

HC 71 T6 0,55kW (A2:6)

HC 71 T6 0,75kW (A2:6)

AIR FLOW - PRESSURE

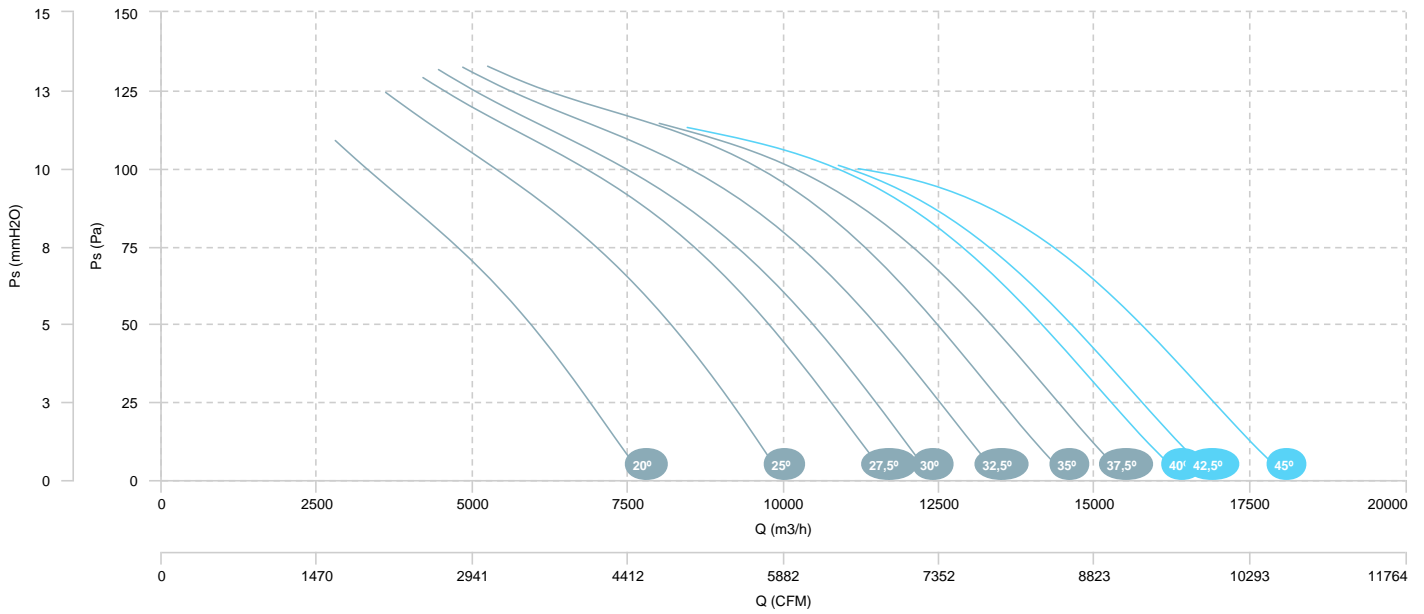

AIR FLOW - ABSORBED POWER

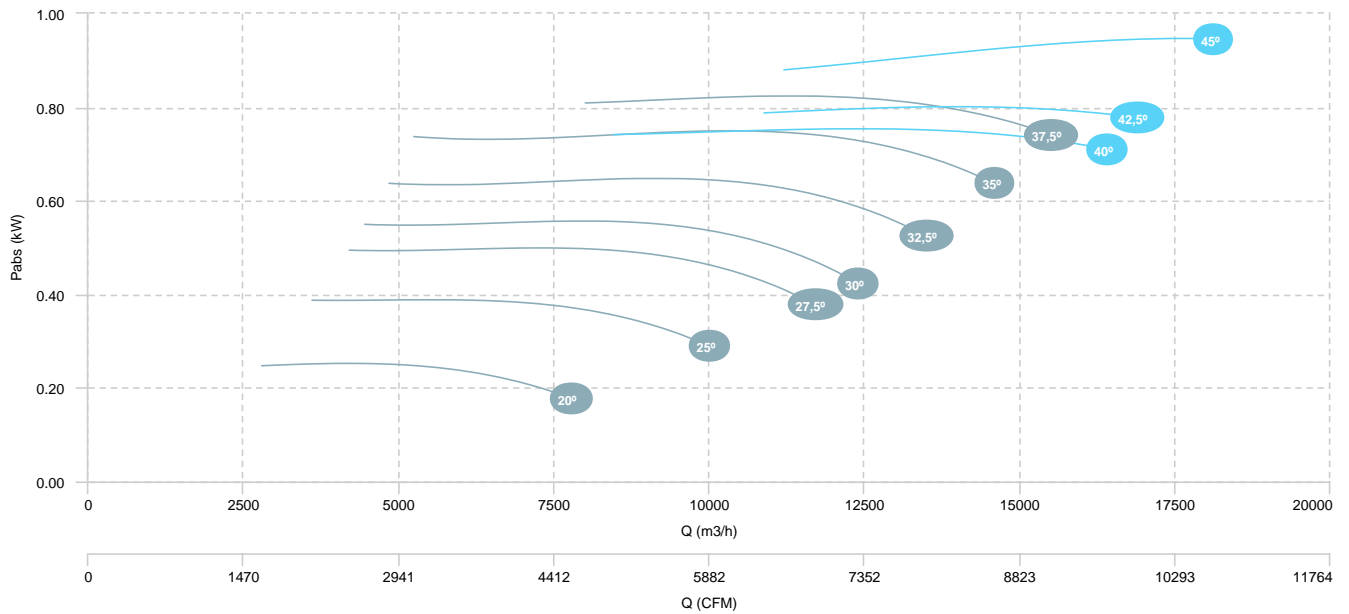

HC 71 T4/T6 0,75/0,25kW (A5:6)	HC 71 T4/T6 1,1/0,37kW (A5:6)	HC 71 T4/T6 1,5/0,5kW (A5:6)
HC 71 T4/T6 2,2/0,6kW (A5:6)	HC 71 T4/T6 3/0,9kW (A5:6)	

AIR FLOW - PRESSURE (4 POLES)

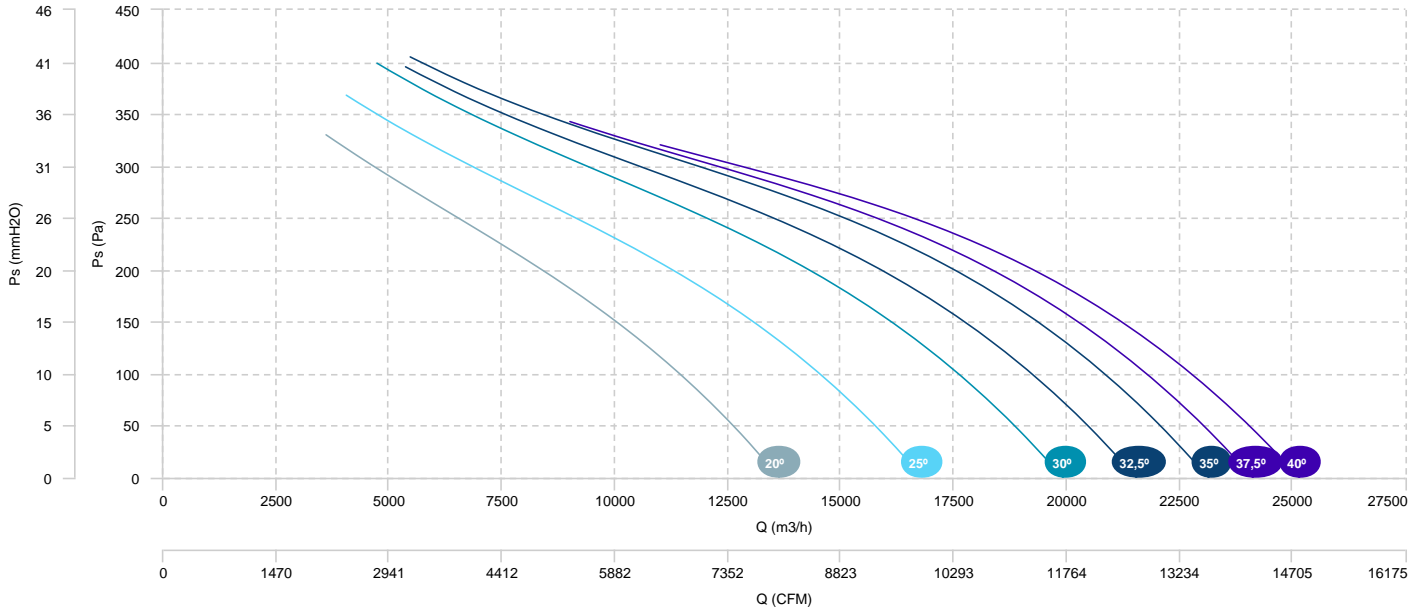

AIR FLOW - ABSORBED POWER (4 POLES)

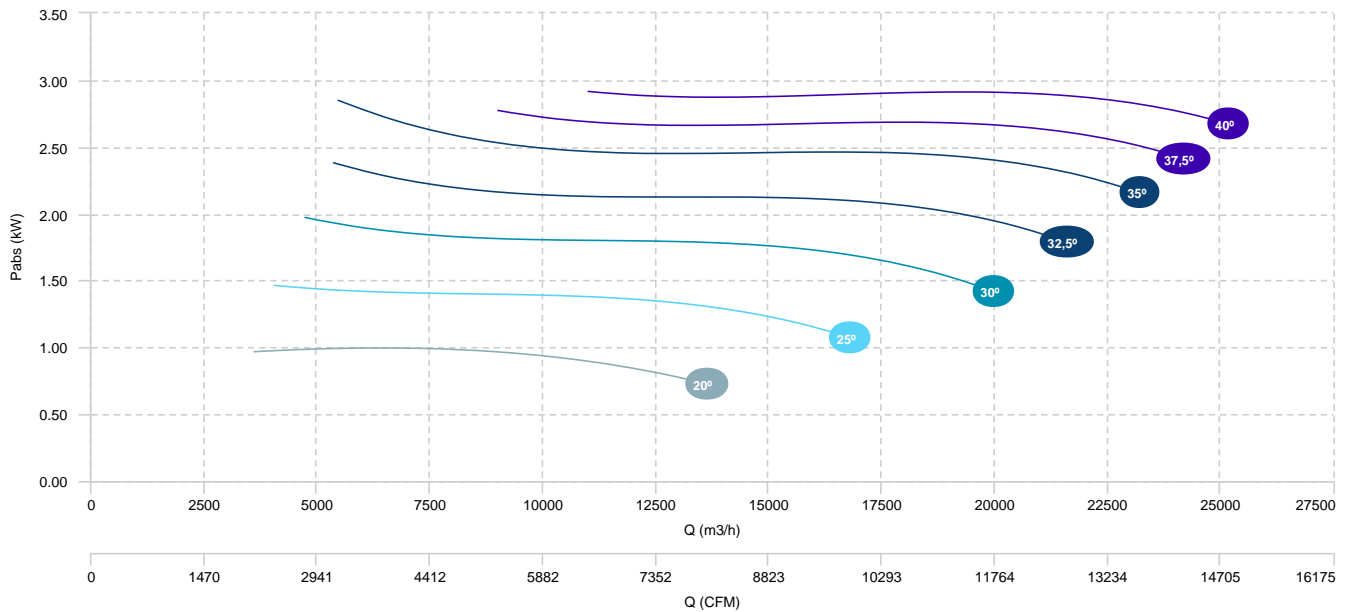

HC 71 T4/T6 0,75/0,25kW (A5:6)	HC 71 T4/T6 1,1/0,37kW (A5:6)	HC 71 T4/T6 1,5/0,5kW (A5:6)
HC 71 T4/T6 2,2/0,6kW (A5:6)	HC 71 T4/T6 3/0,9kW (A5:6)	

AIR FLOW - PRESSURE (6 POLES)

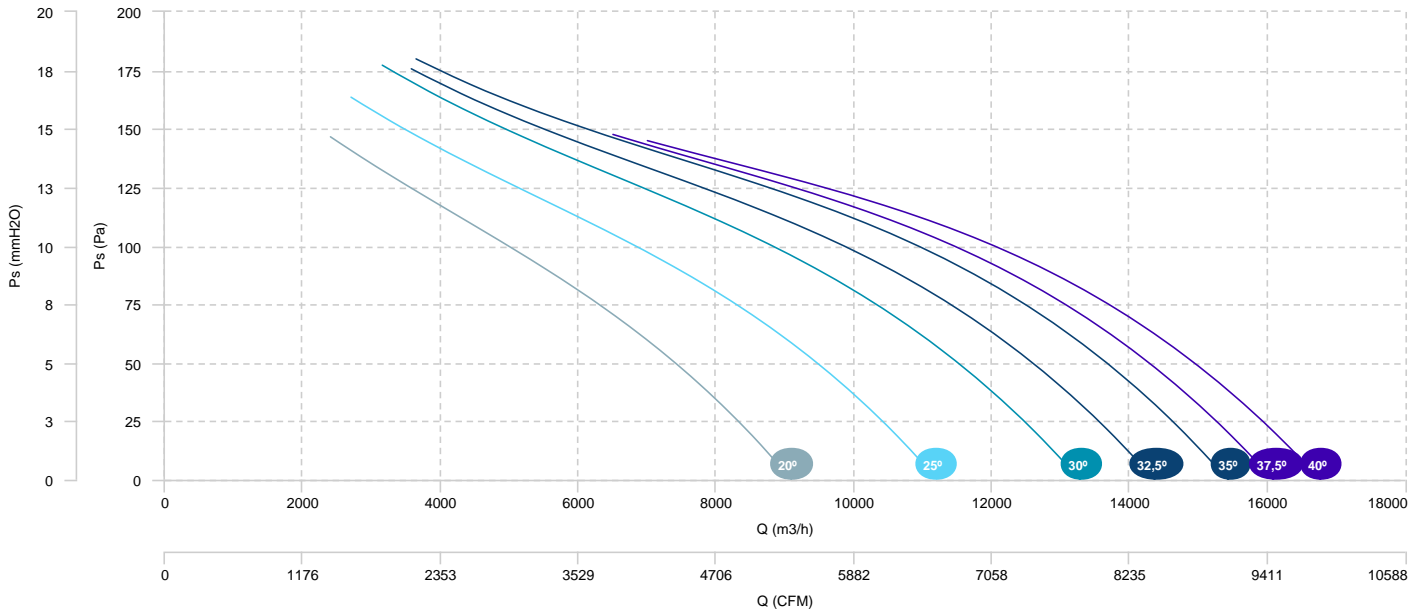

HC 71 T4/T6 1,1/0,37kW (A2:9)
 HC 71 T4/T6 3/0,9kW (A2:9)

HC 71 T4/T6 1,5/0,5kW (A2:9)

HC 71 T4/T6 2,2/0,6kW (A2:9)

AIR FLOW - PRESSURE (4 POLES)

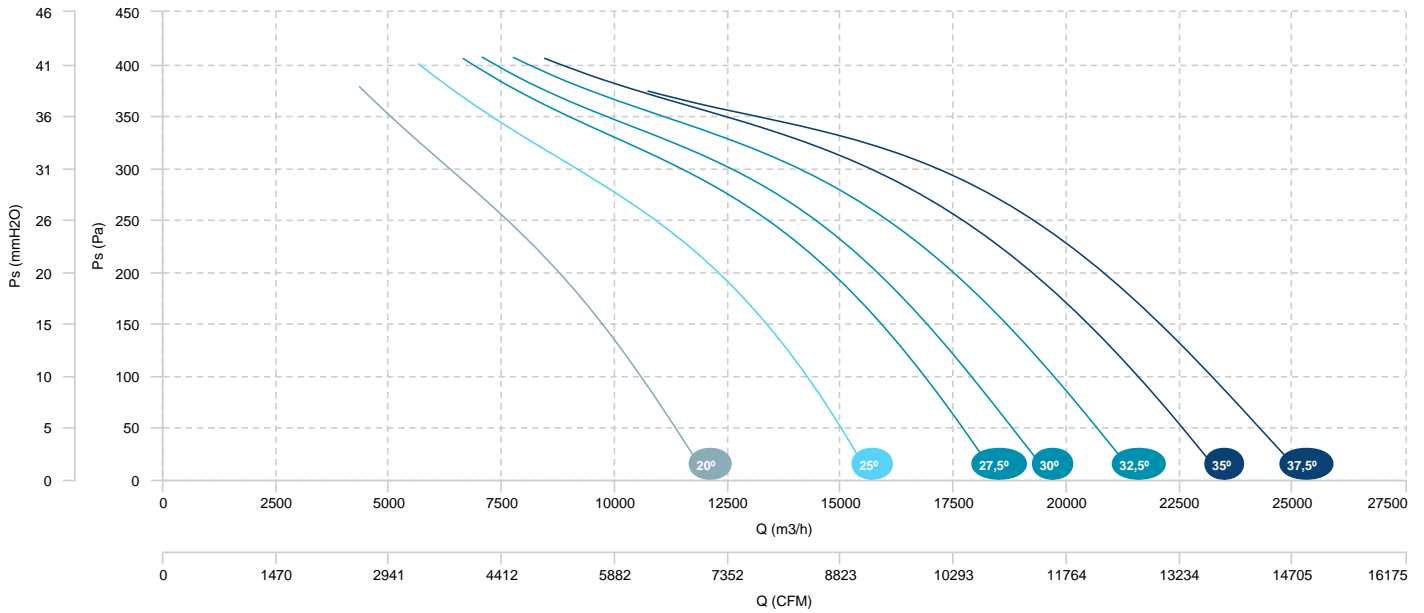

AIR FLOW - ABSORBED POWER (4 POLES)

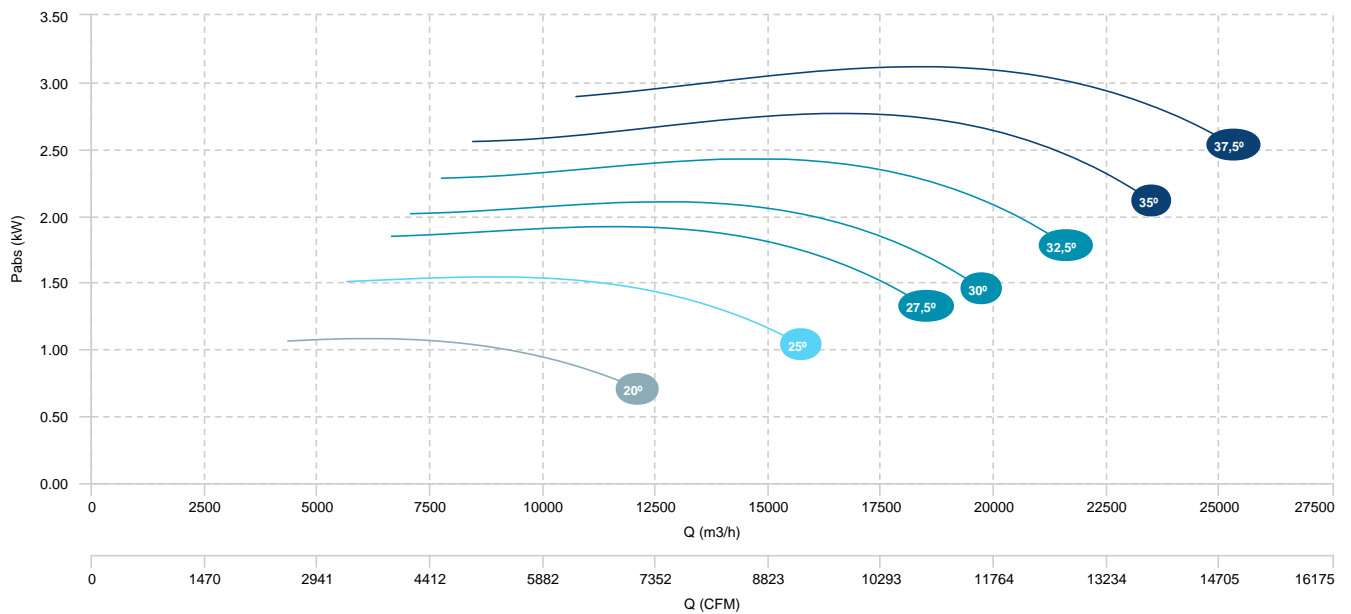

HC 71 T4/T6 1,1/0,37kW (A2:9)	HC 71 T4/T6 1,5/0,5kW (A2:9)	HC 71 T4/T6 2,2/0,6kW (A2:9)
HC 71 T4/T6 3/0,9kW (A2:9)		

AIR FLOW - PRESSURE (6 POLES)

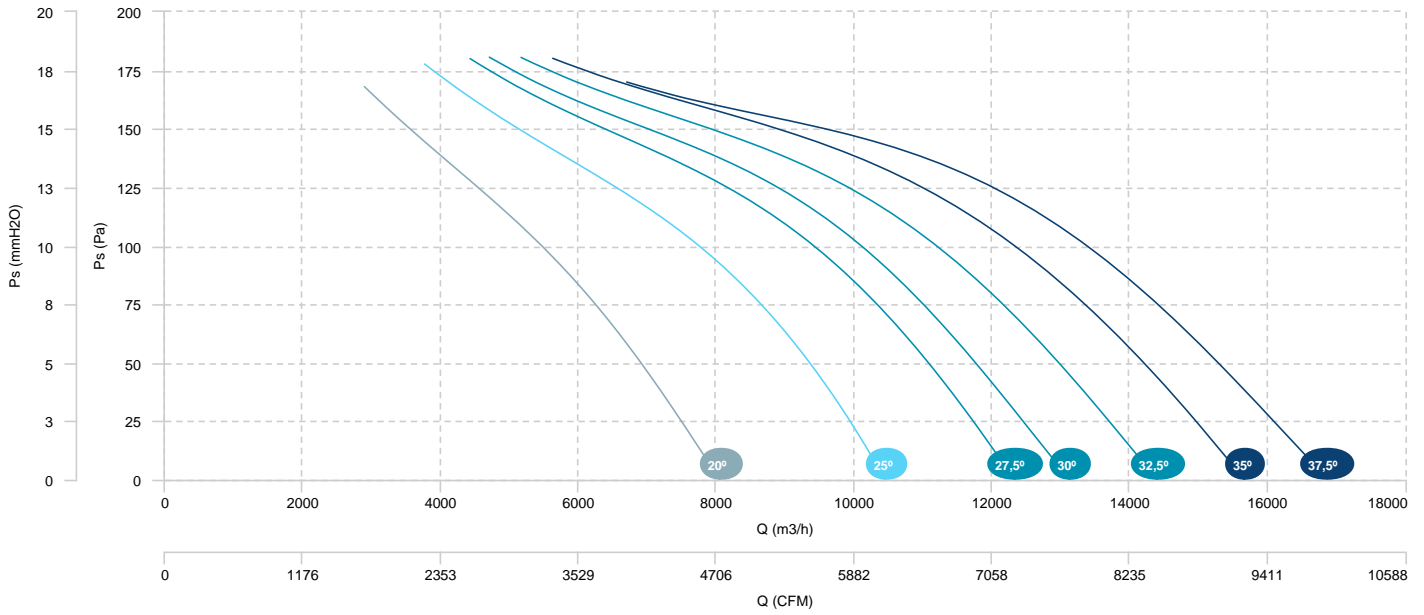

HC 71 T4/T6 0,75/0,25kW (A2:6)	HC 71 T4/T6 1,1/0,37kW (A2:6)	HC 71 T4/T6 1,5/0,5kW (A2:6)
HC 71 T4/T6 2,2/0,6kW (A2:6)	HC 71 T4/T6 3/0,9kW (A2:6)	

AIR FLOW - PRESSURE (4 POLES)

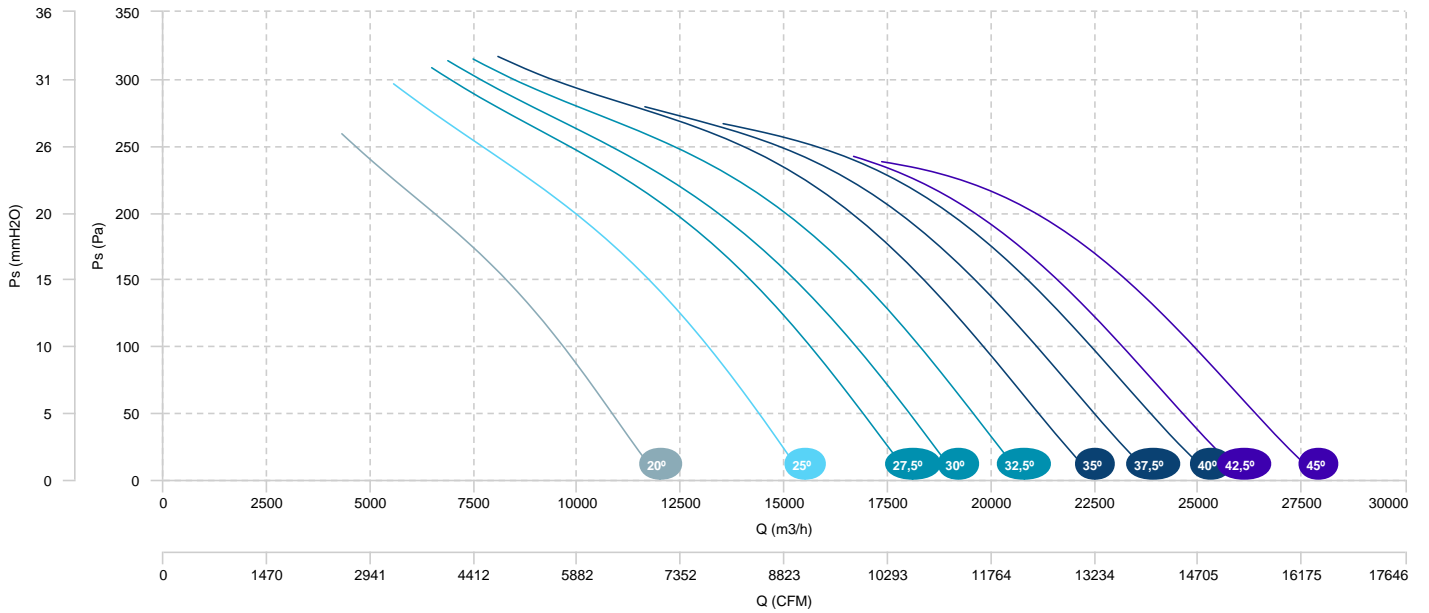

AIR FLOW - ABSORBED POWER (4 POLES)

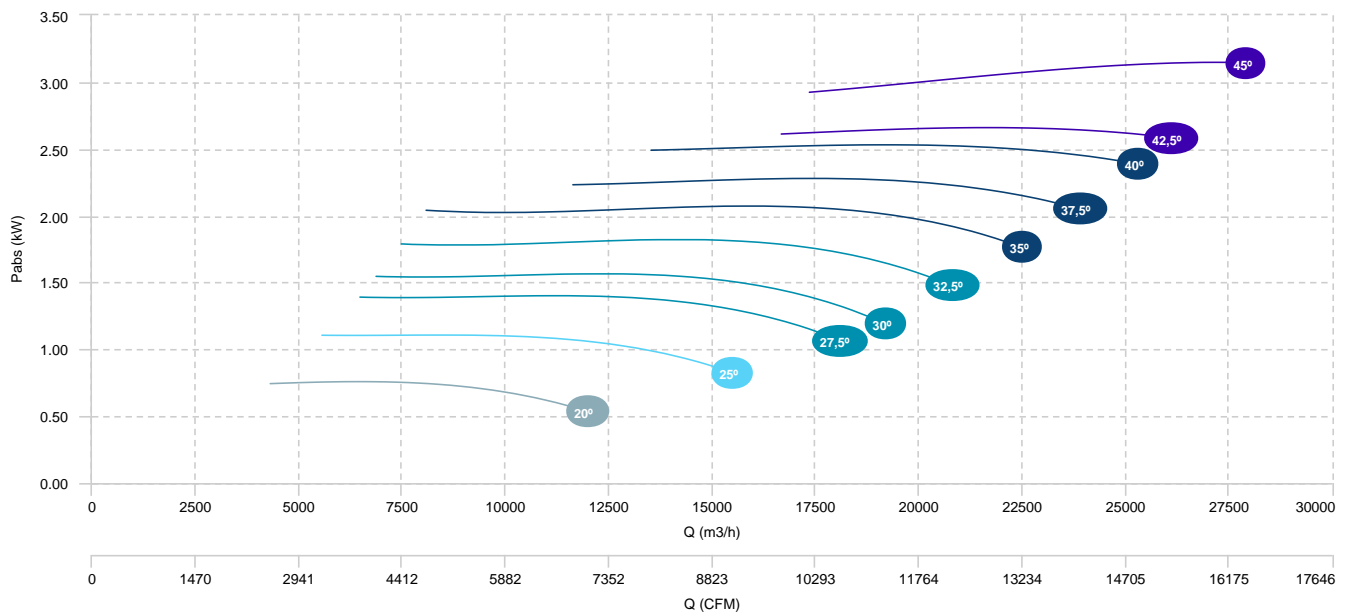

HC 71 T4/T6 0,75/0,25kW (A2:6)	HC 71 T4/T6 1,1/0,37kW (A2:6)	HC 71 T4/T6 1,5/0,5kW (A2:6)
HC 71 T4/T6 2,2/0,6kW (A2:6)	HC 71 T4/T6 3/0,9kW (A2:6)	

AIR FLOW - PRESSURE (6 POLES)

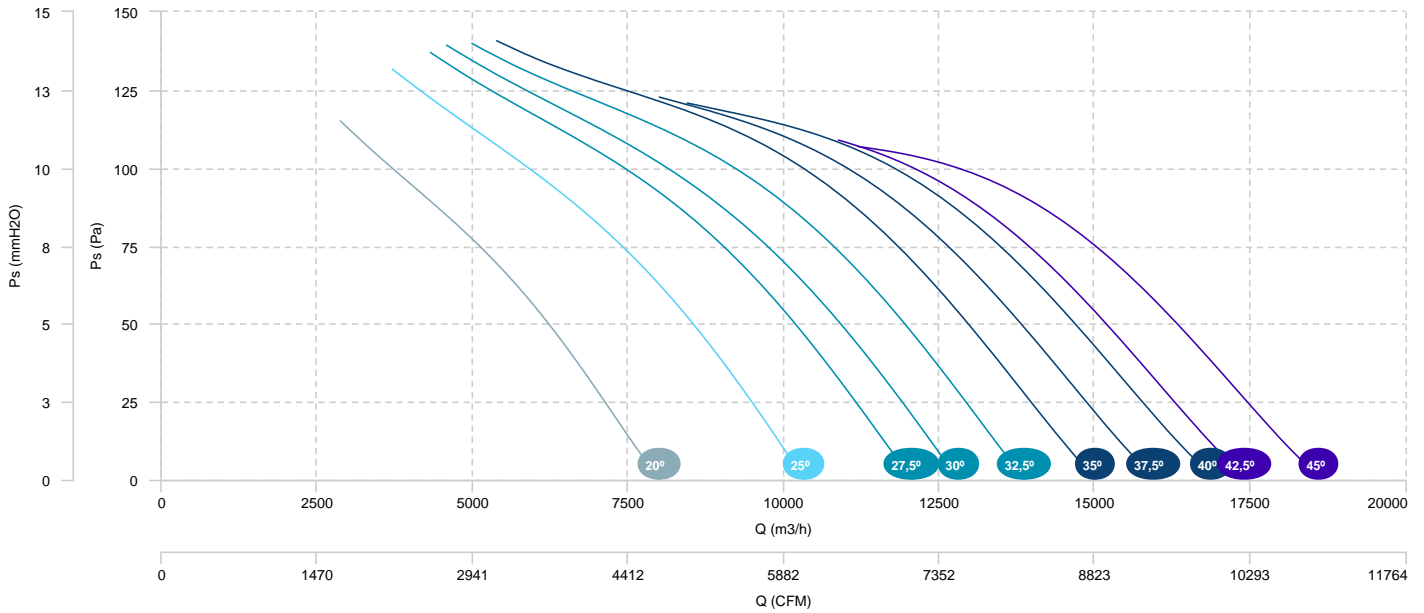

HC 71 T4/T8 1,1/0,18kW (A2:9)
 HC 71 T4/T8 3/0,55kW (A2:9)

HC 71 T4/T8 1,5/0,25kW (A2:9)

HC 71 T4/T8 2,2/0,37kW (A2:9)

AIR FLOW - PRESSURE (4 POLES)

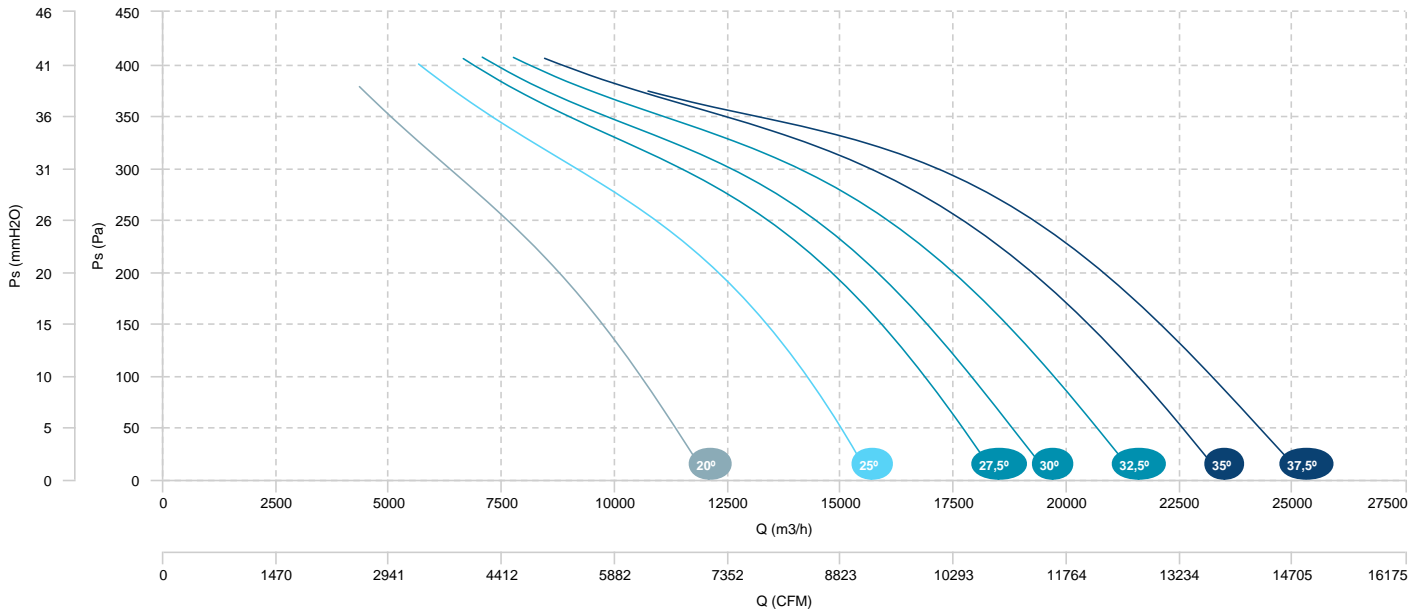

AIR FLOW - ABSORBED POWER (4 POLES)

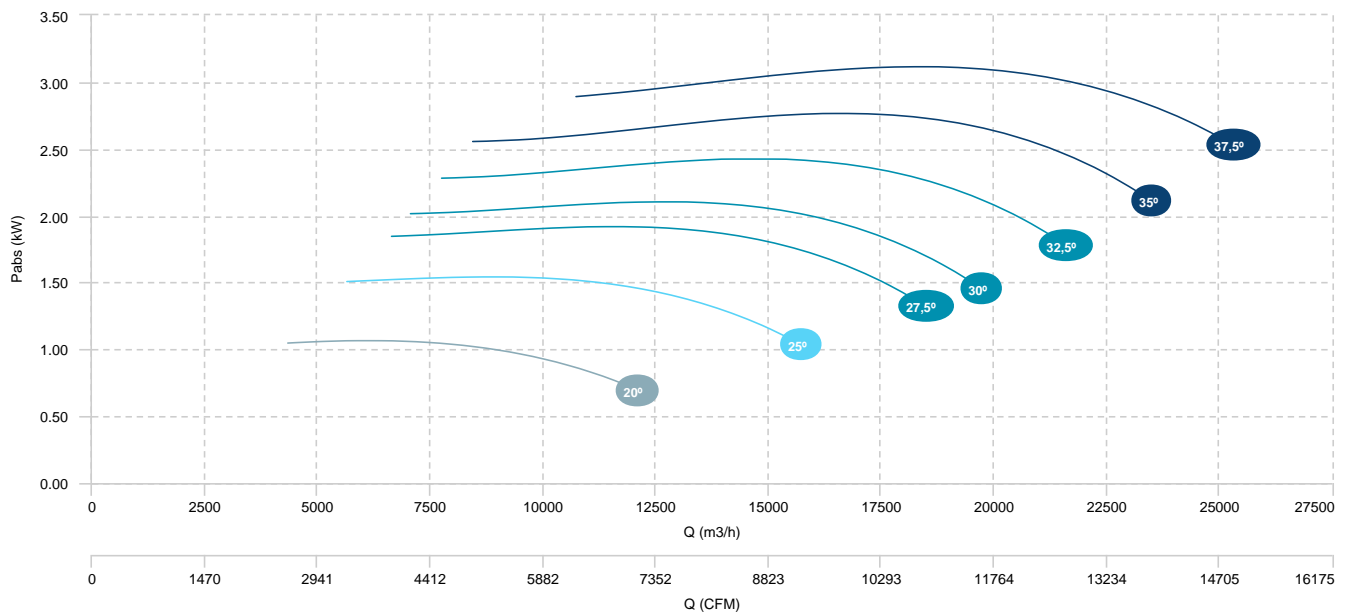

HC 71 T4/T8 1,1/0,18kW (A2:9)
 HC 71 T4/T8 3/0,55kW (A2:9)

HC 71 T4/T8 1,5/0,25kW (A2:9)

HC 71 T4/T8 2,2/0,37kW (A2:9)

AIR FLOW - PRESSURE (8 POLES)

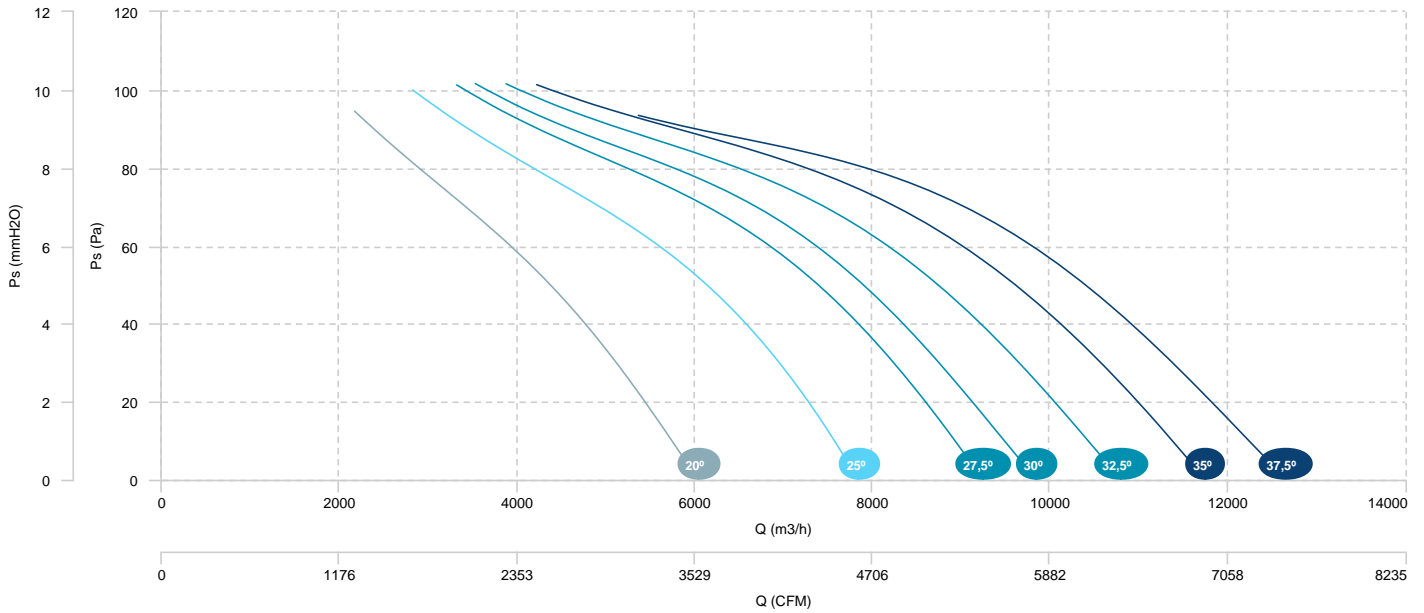

HC 71 T4/T8 0,75/0,12kW (A5:6)	HC 71 T4/T8 1,1/0,18kW (A5:6)	HC 71 T4/T8 1,5/0,25kW (A5:6)
HC 71 T4/T8 2,2/0,37kW (A5:6)	HC 71 T4/T8 3/0,55kW (A5:6)	

AIR FLOW - PRESSURE (4 POLES)

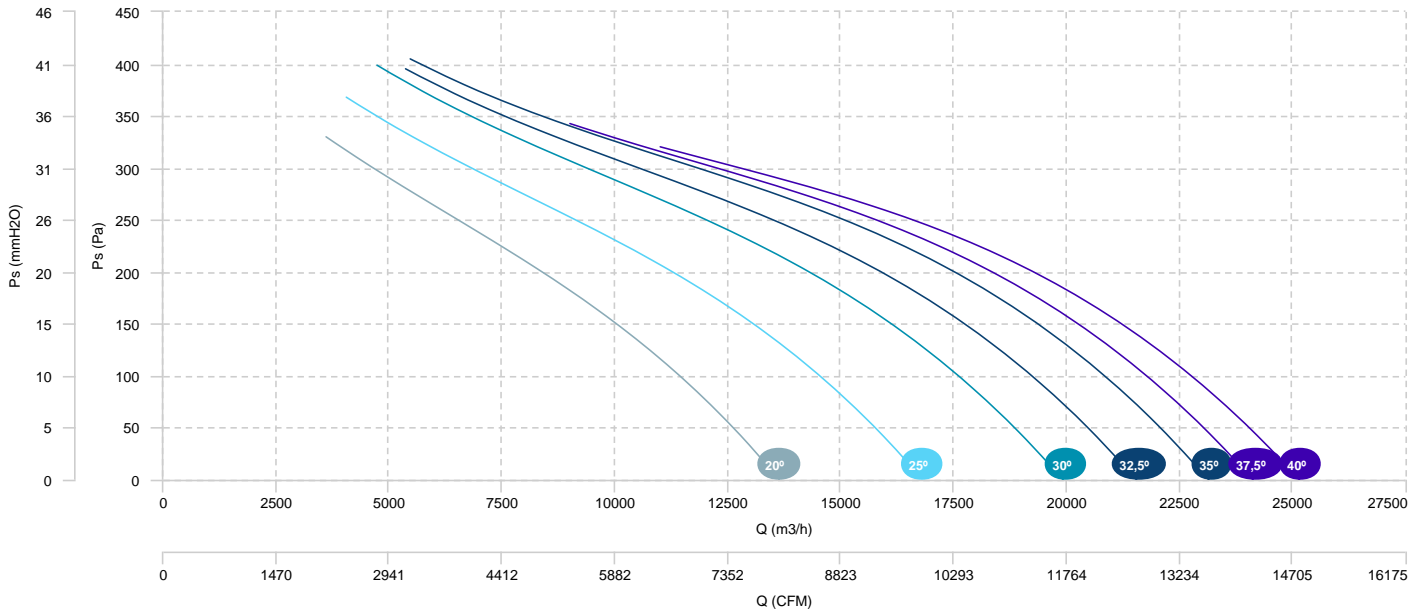

AIR FLOW - ABSORBED POWER (4 POLES)

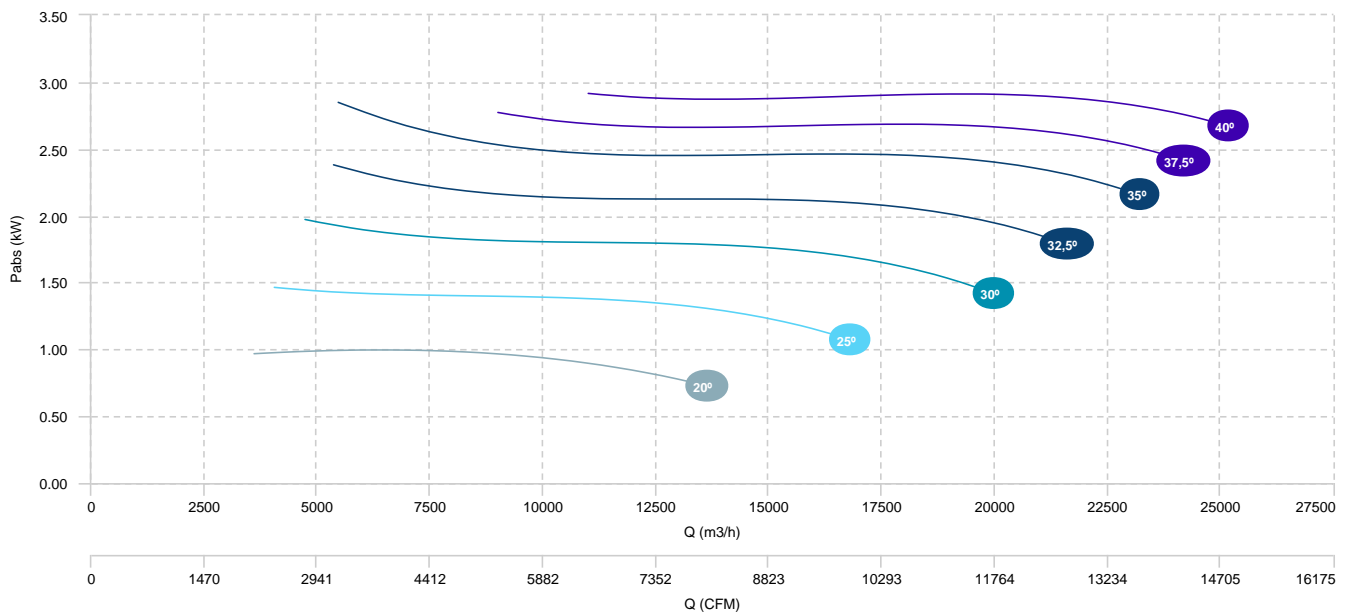

HC 71 T4/T8 0,75/0,12kW (A5:6)	HC 71 T4/T8 1,1/0,18kW (A5:6)	HC 71 T4/T8 1,5/0,25kW (A5:6)
HC 71 T4/T8 2,2/0,37kW (A5:6)	HC 71 T4/T8 3/0,55kW (A5:6)	

AIR FLOW - PRESSURE (8 POLES)

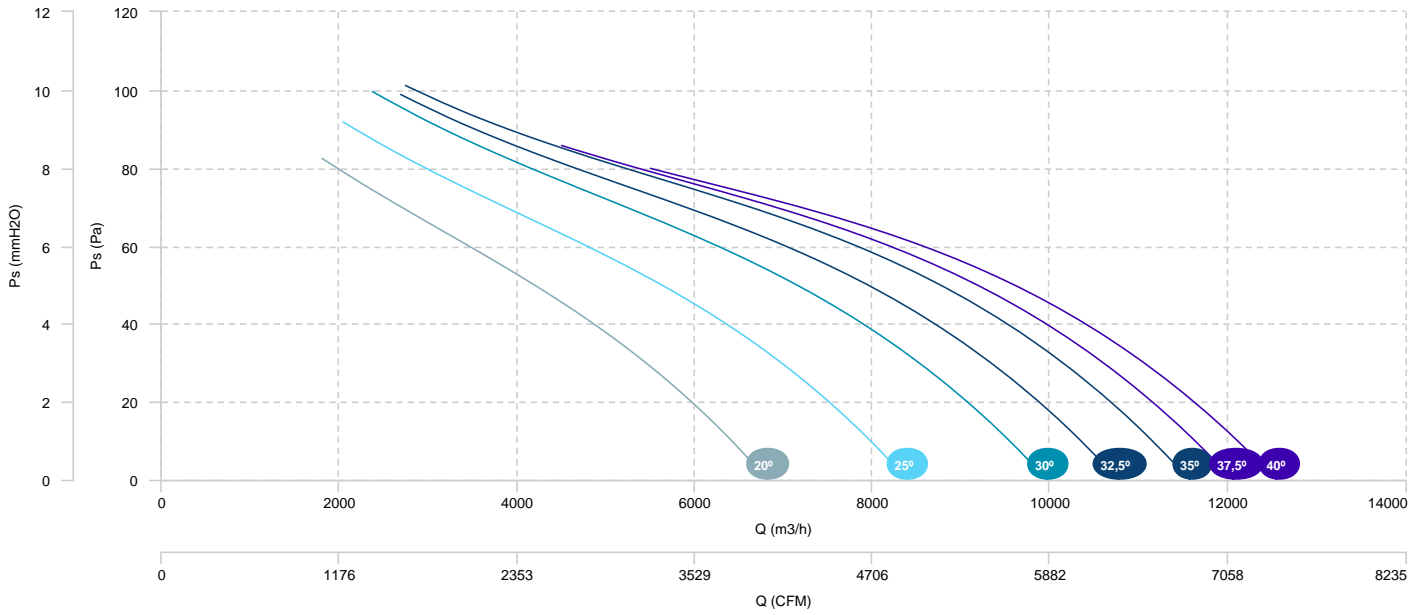

HC 71 T4/T8 0,75/0,12kW (A2:6)	HC 71 T4/T8 1,1/0,18kW (A2:6)	HC 71 T4/T8 1,5/0,25kW (A2:6)
HC 71 T4/T8 2,2/0,37kW (A2:6)	HC 71 T4/T8 3/0,55kW (A2:6)	

AIR FLOW - PRESSURE (4 POLES)

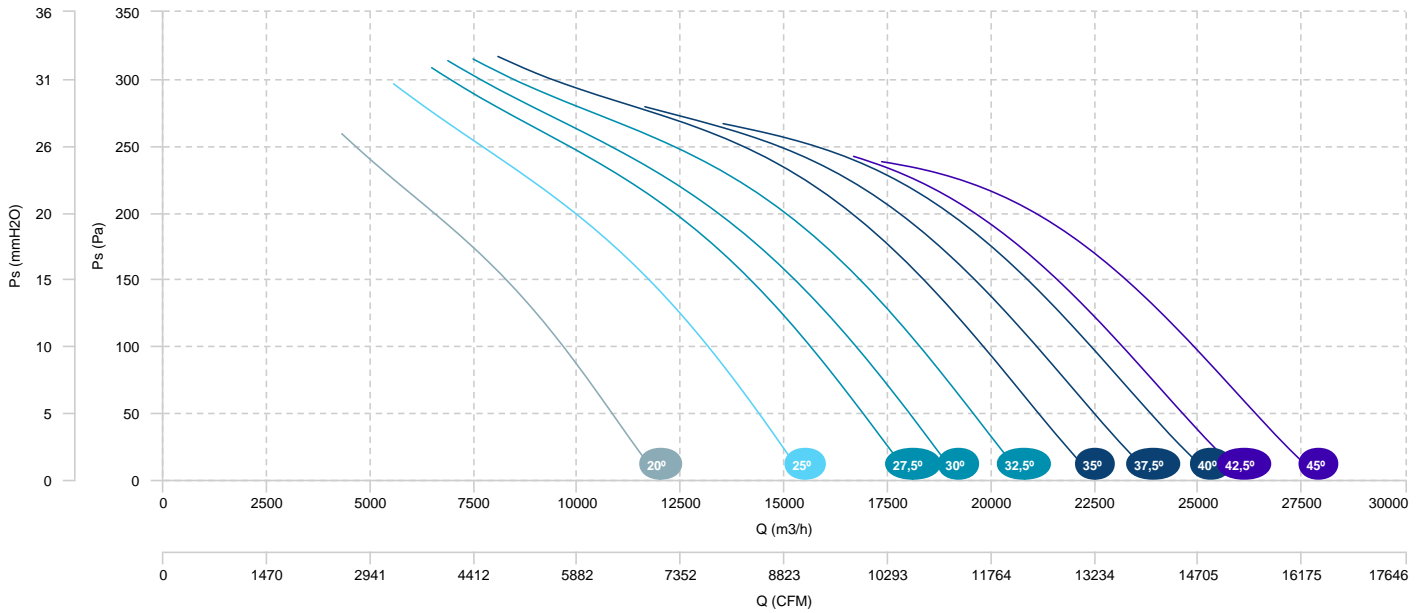

AIR FLOW - ABSORBED POWER (4 POLES)

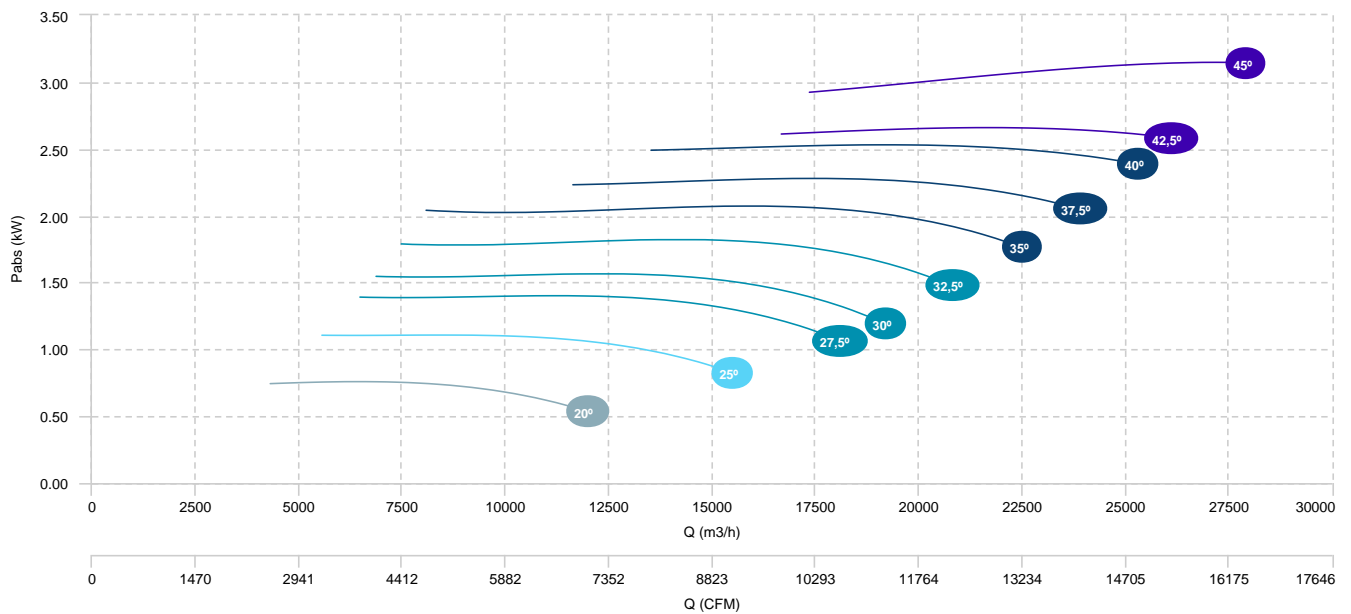

HC 71 T4/T8 0,75/0,12kW (A2:6)	HC 71 T4/T8 1,1/0,18kW (A2:6)	HC 71 T4/T8 1,5/0,25kW (A2:6)
HC 71 T4/T8 2,2/0,37kW (A2:6)	HC 71 T4/T8 3/0,55kW (A2:6)	

AIR FLOW - PRESSURE (8 POLES)

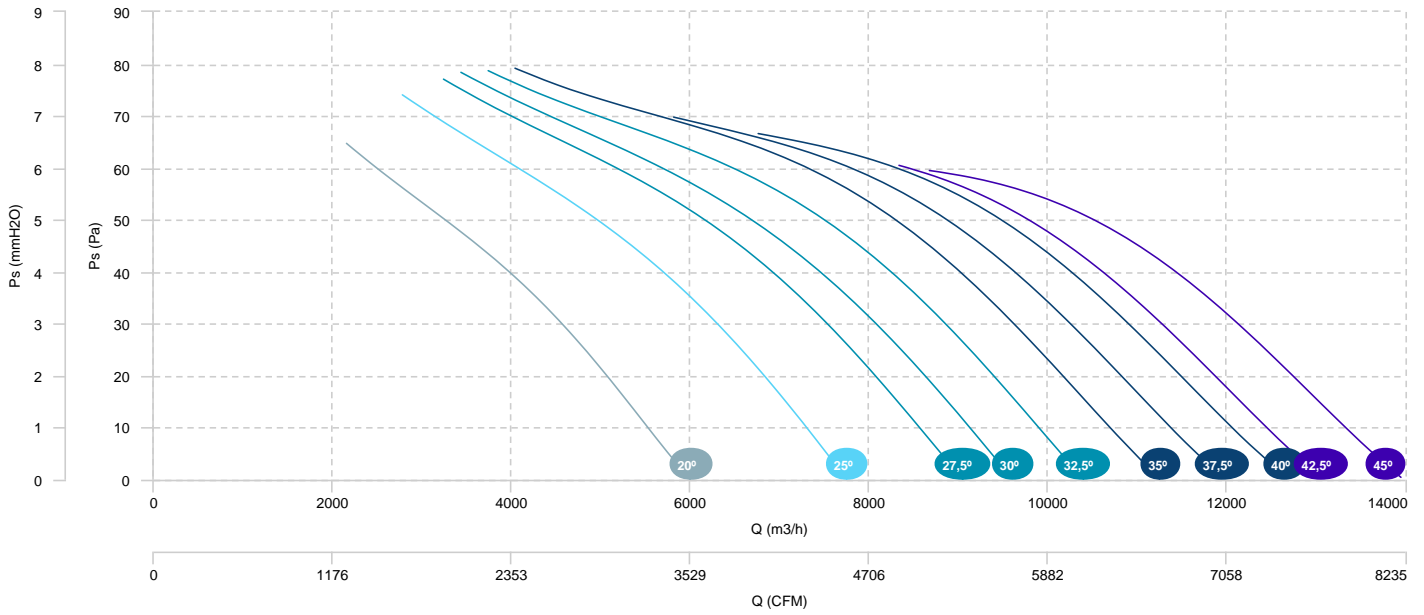

HC 80 T4 3kW (A5:6)

HC 80 T4 4kW (A5:6)

AIR FLOW - PRESSURE

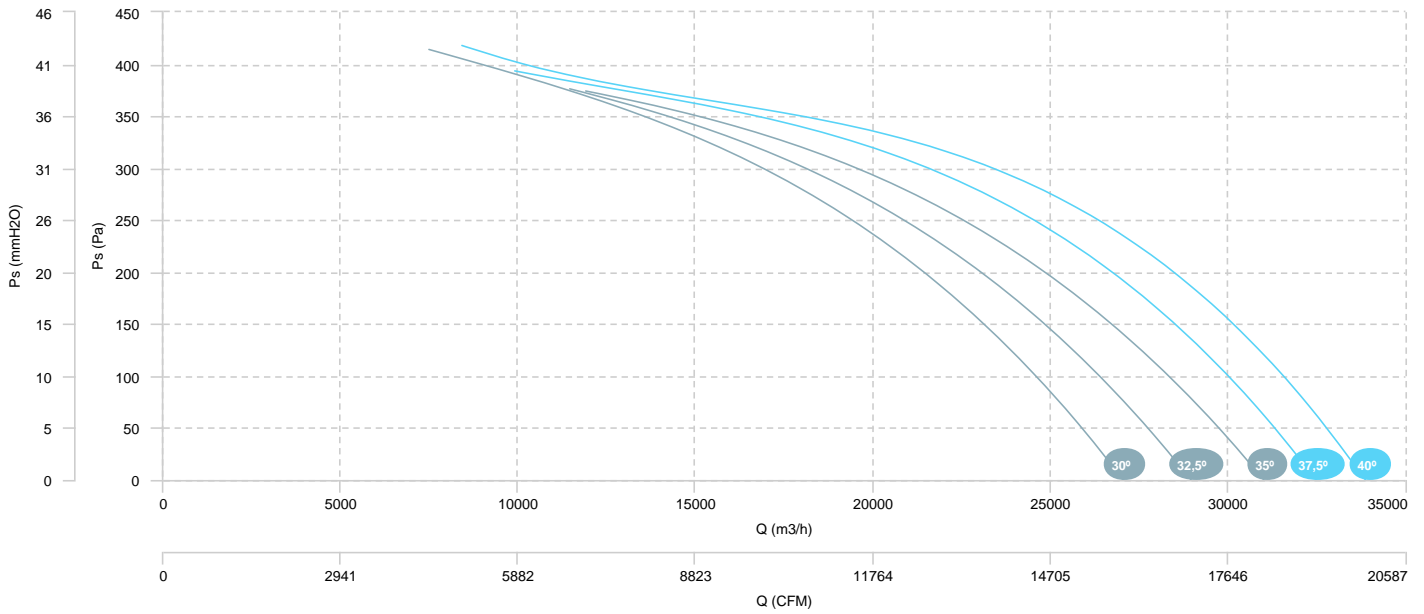

AIR FLOW - ABSORBED POWER

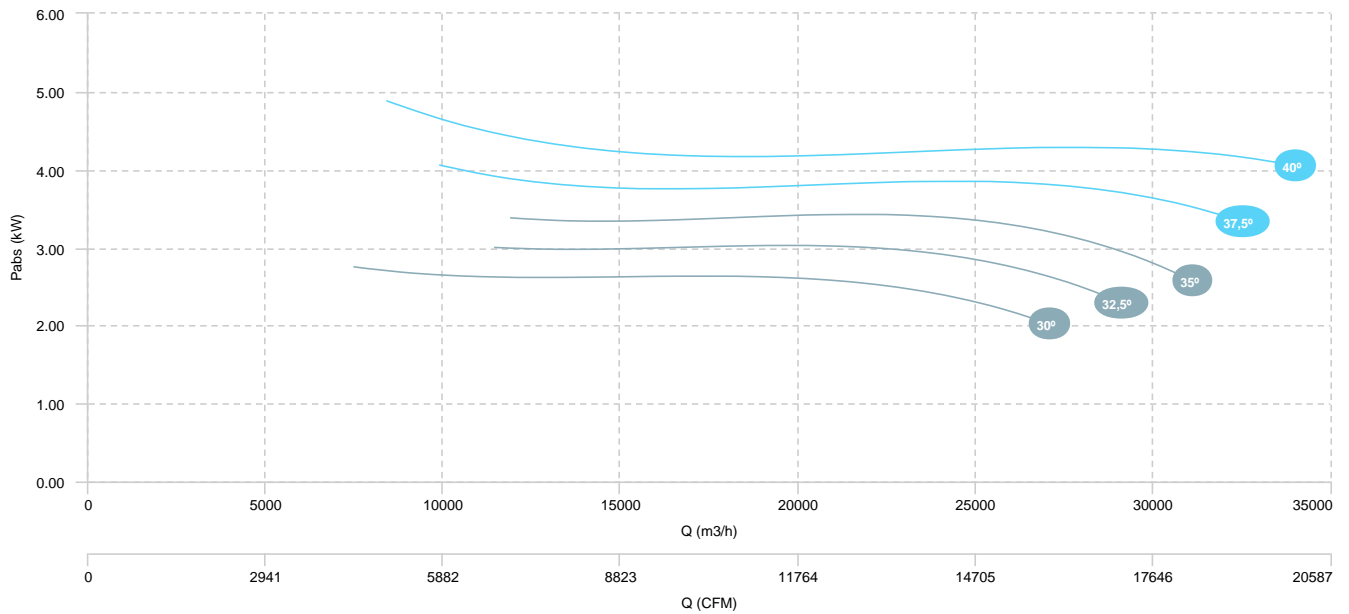

HC 80 T4 1,5KW (A2:9)	HC 80 T4 2,2kW (A2:9)	HC 80 T4 3kW (A2:9)
HC 80 T4 4kW (A2:9)	HC 80 T4 5,5kW (A2:9)	

AIR FLOW - PRESSURE

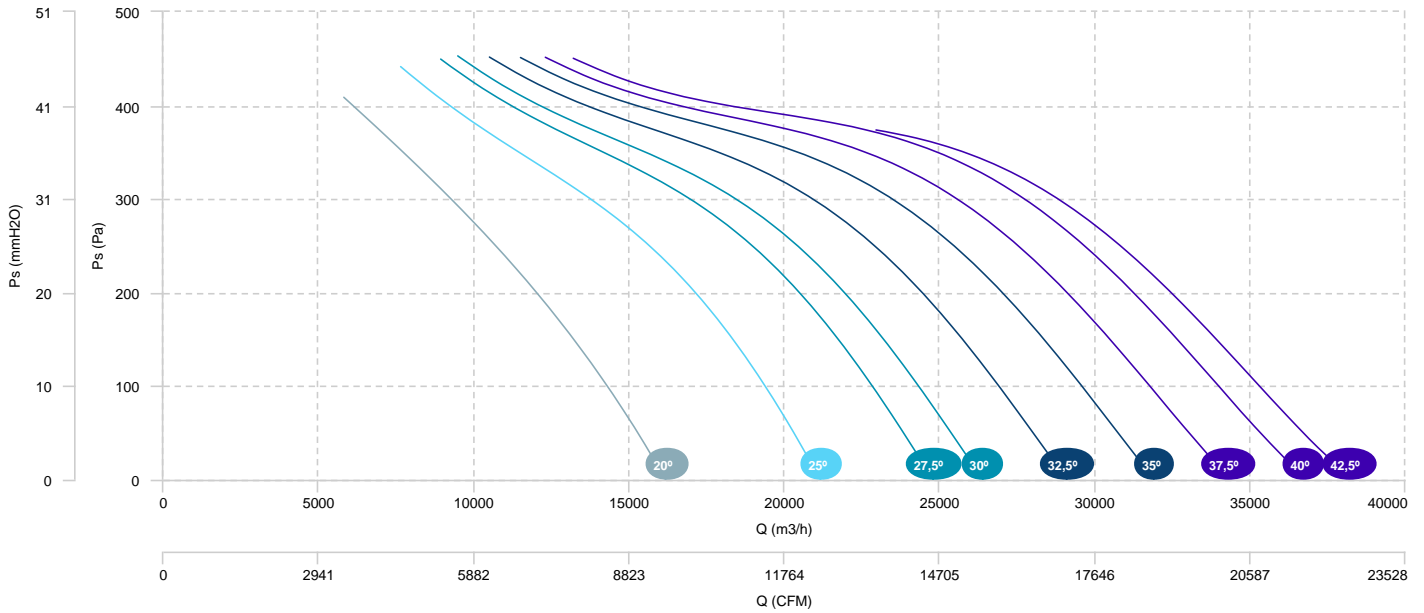

AIR FLOW - ABSORBED POWER

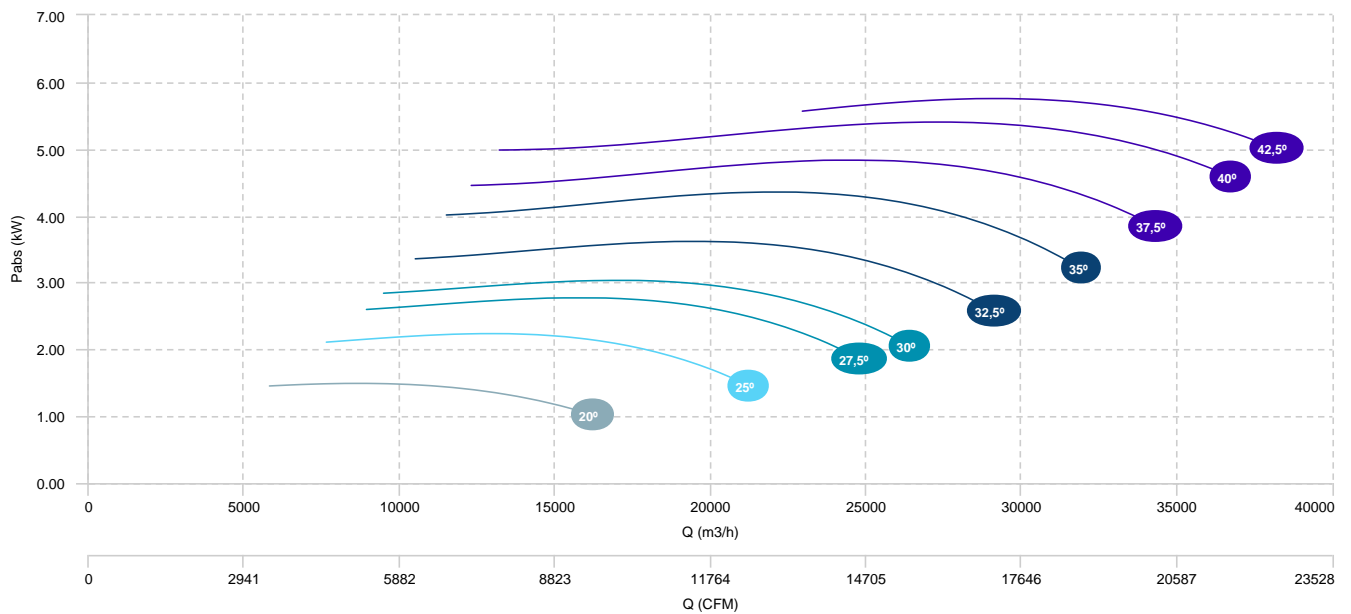

HC 80 T4 1,1KW (A2:6)	HC 80 T4 1,5KW (A2:6)	HC 80 T4 2,2kW (A2:6)
HC 80 T4 3kW (A2:6)	HC 80 T4 4kW (A2:6)	HC 80 T4 5,5kW (A2:6)

AIR FLOW - PRESSURE

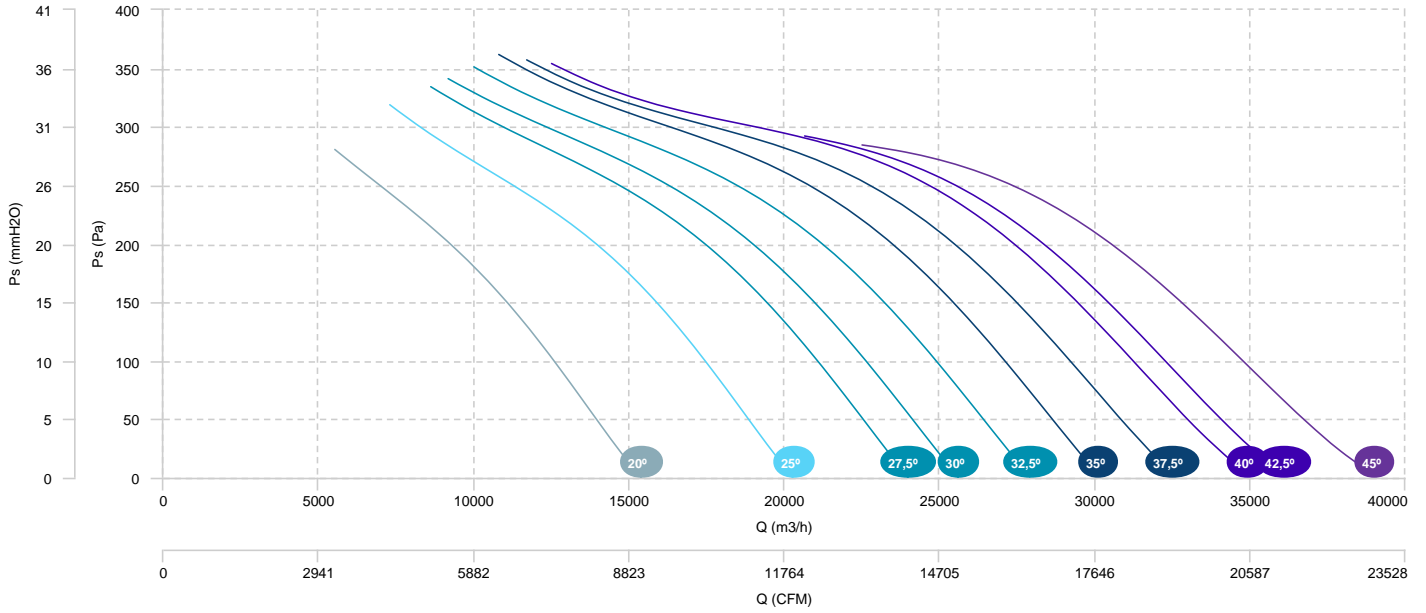

AIR FLOW - ABSORBED POWER

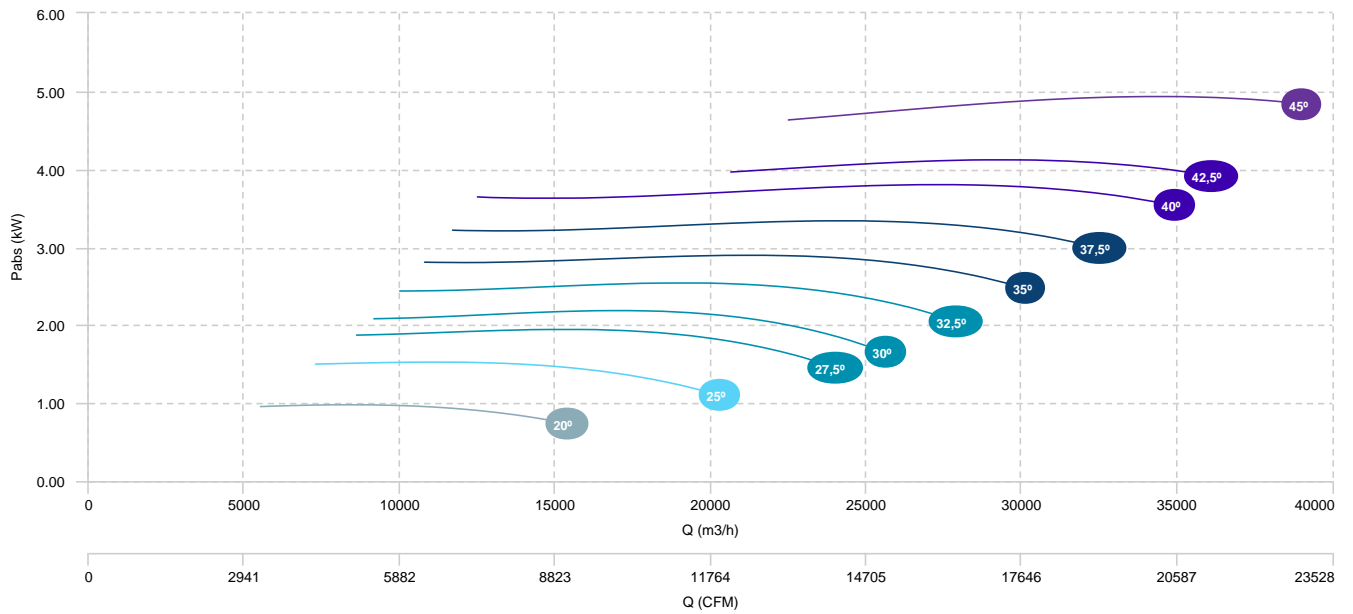

- HC 80 T6 0,75kW (A5:6)
- HC 80 T6 1,1kW (A5:6)
- HC 80 T6 1,5kW (A5:6)
- HC 80 T6 2,2kW (A5:6)

AIR FLOW - PRESSURE

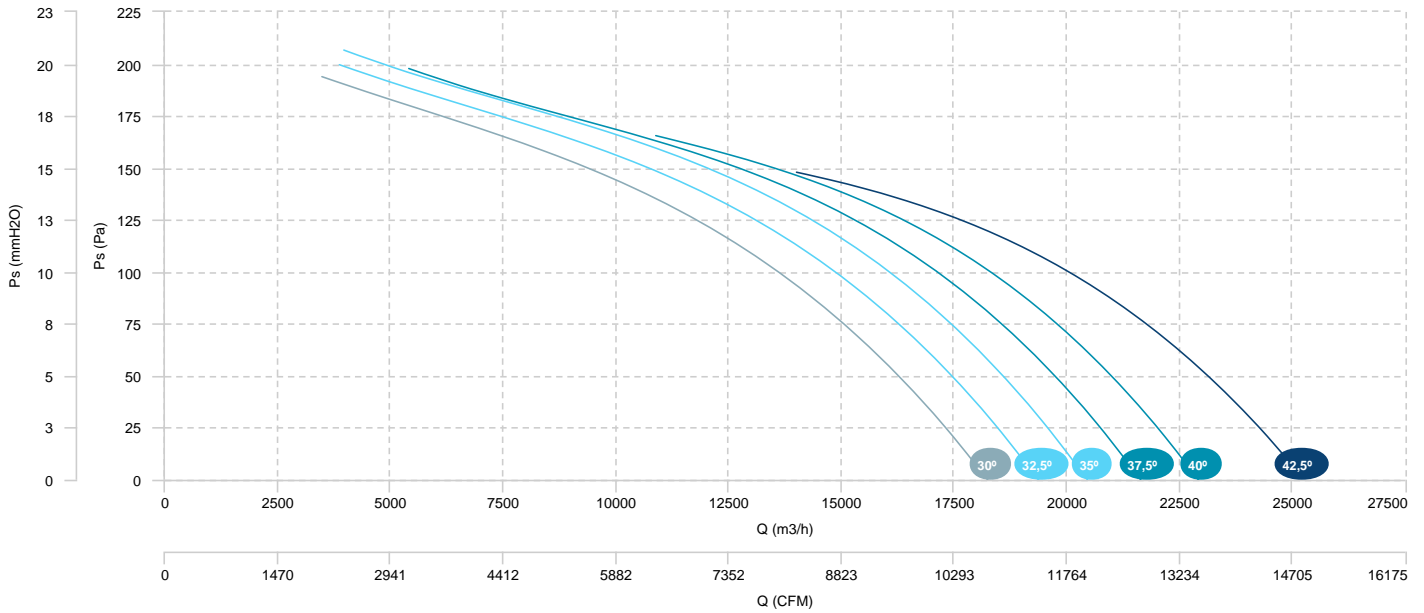

AIR FLOW - ABSORBED POWER

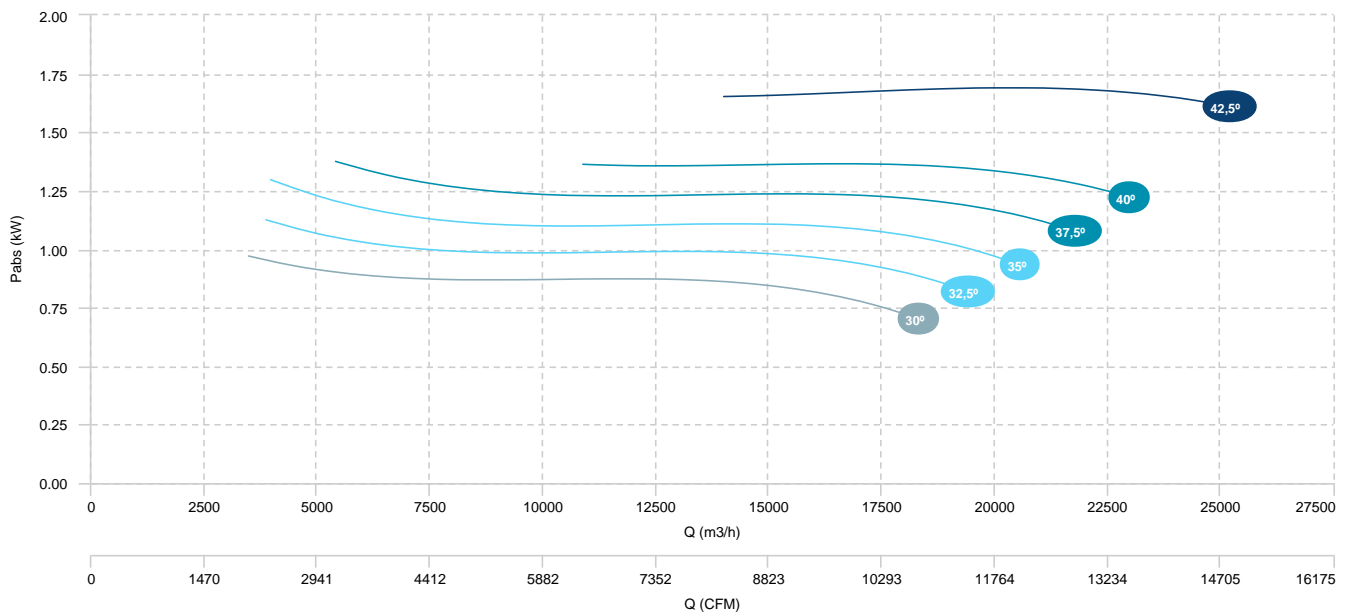

- HC 80 T6 0,75kW (A2:9)
- HC 80 T6 1,1kW (A2:9)
- HC 80 T6 1,5kW (A2:9)
- HC 80 T6 2,2kW (A2:9)

AIR FLOW - PRESSURE

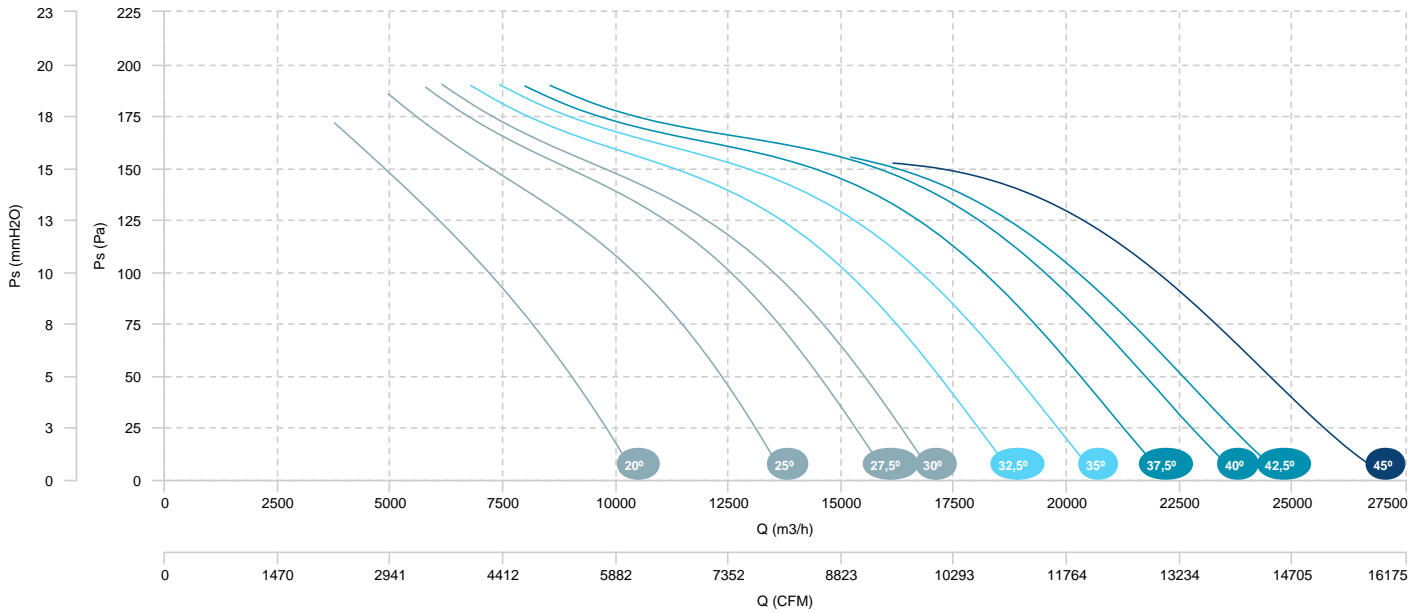

AIR FLOW - ABSORBED POWER

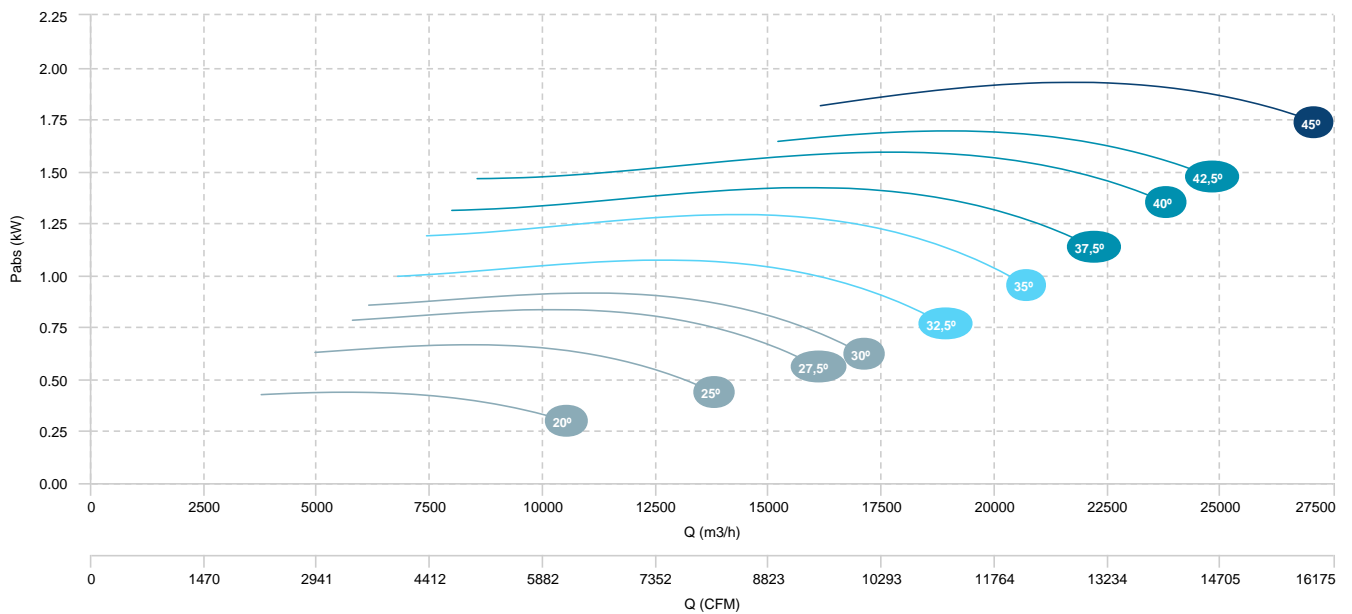

HC 80 T6 0,75kW (A2:6)

HC 80 T6 1,1kW (A2:6)

HC 80 T6 1,5KW (A2:6)

AIR FLOW - PRESSURE

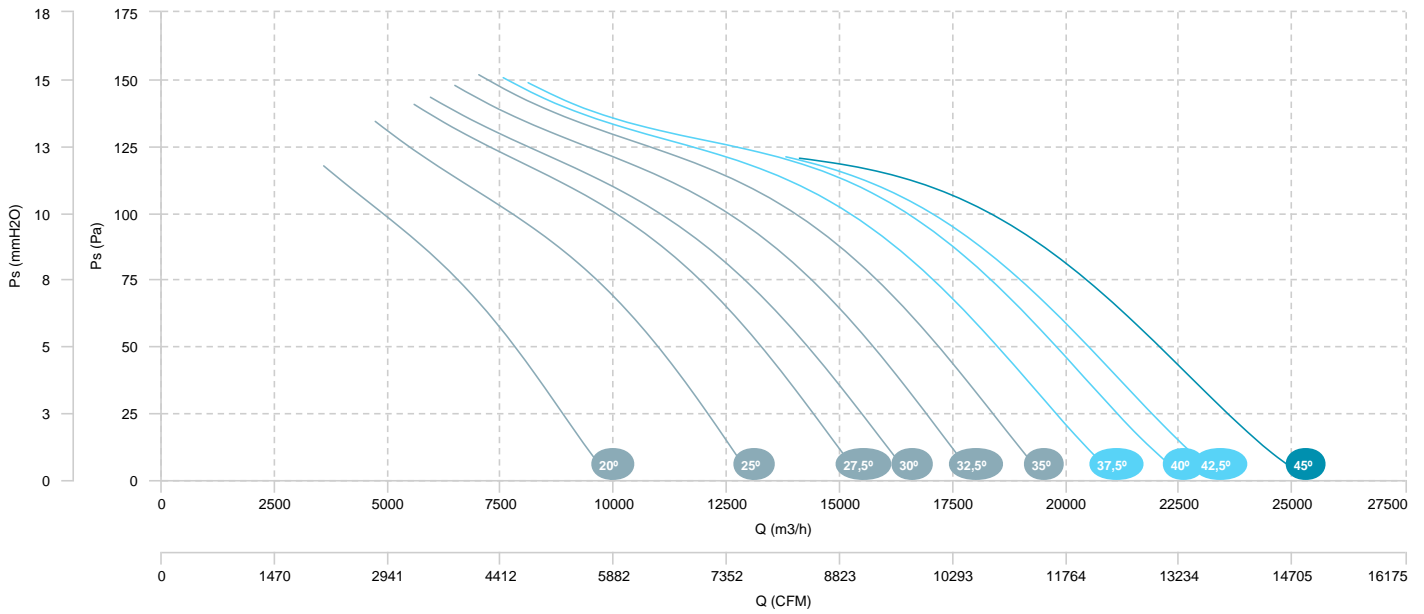

AIR FLOW - ABSORBED POWER

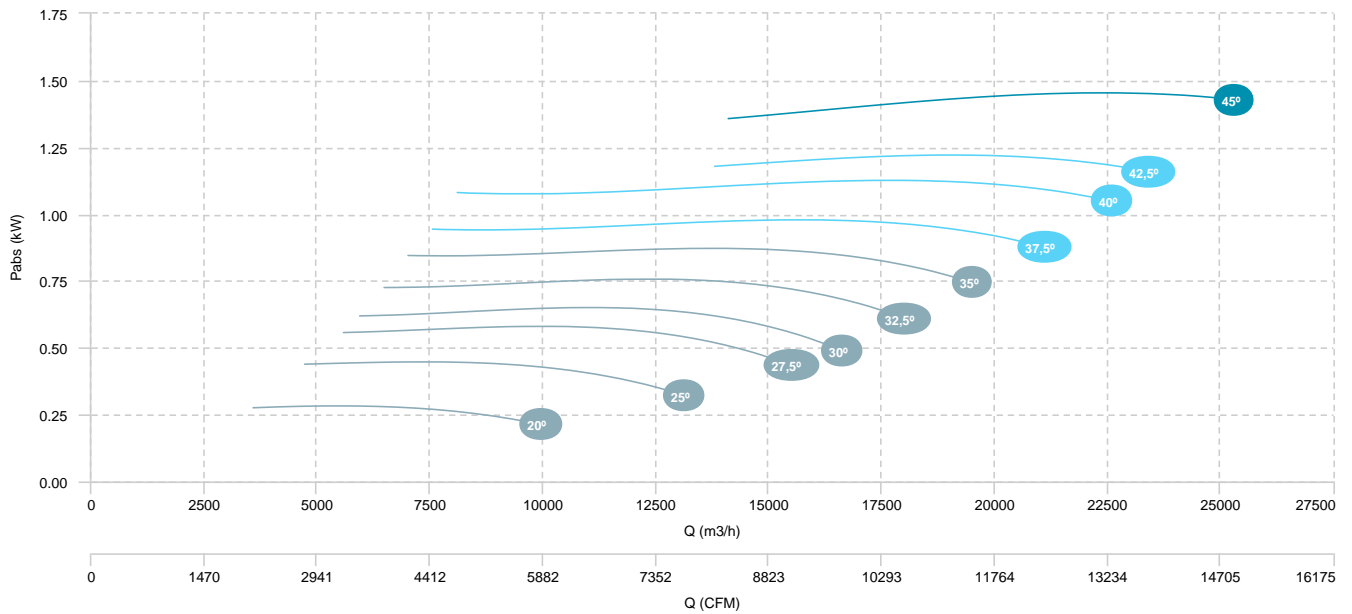

HC 80 T4/T6 3/0,9kW (A5:6)

HC 80 T4/T6 4/1,1kW (A5:6)

AIR FLOW - PRESSURE (4 POLES)

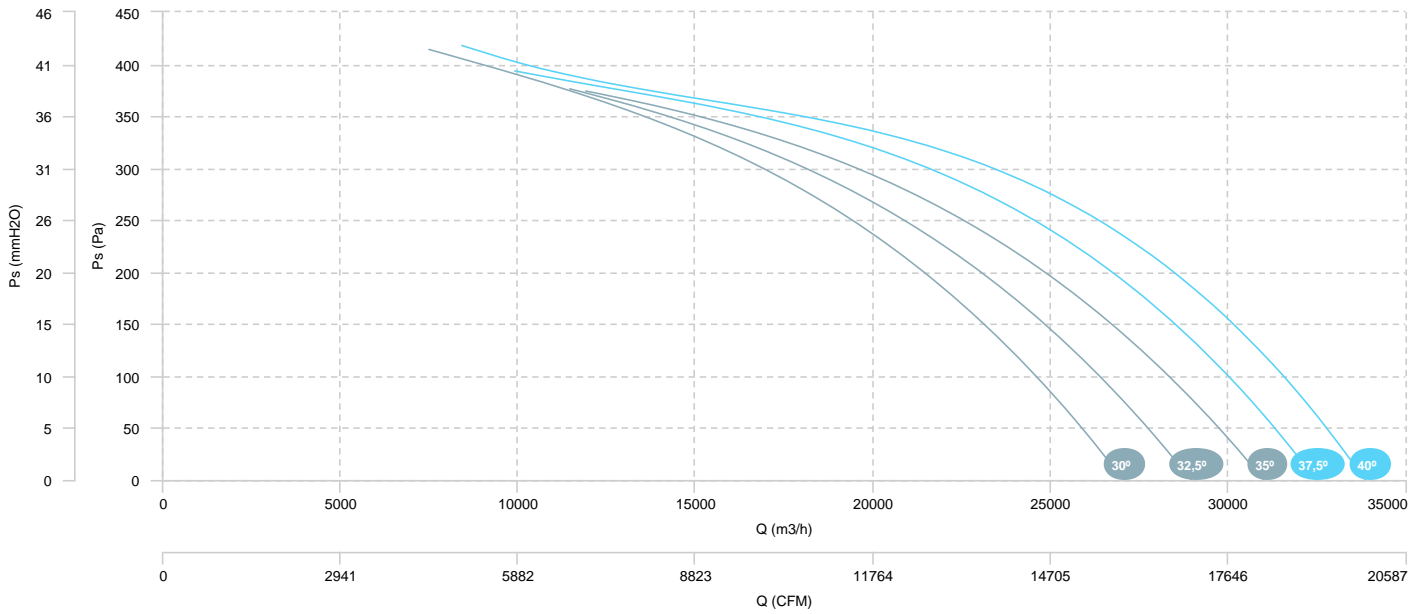

AIR FLOW - ABSORBED POWER (4 POLES)

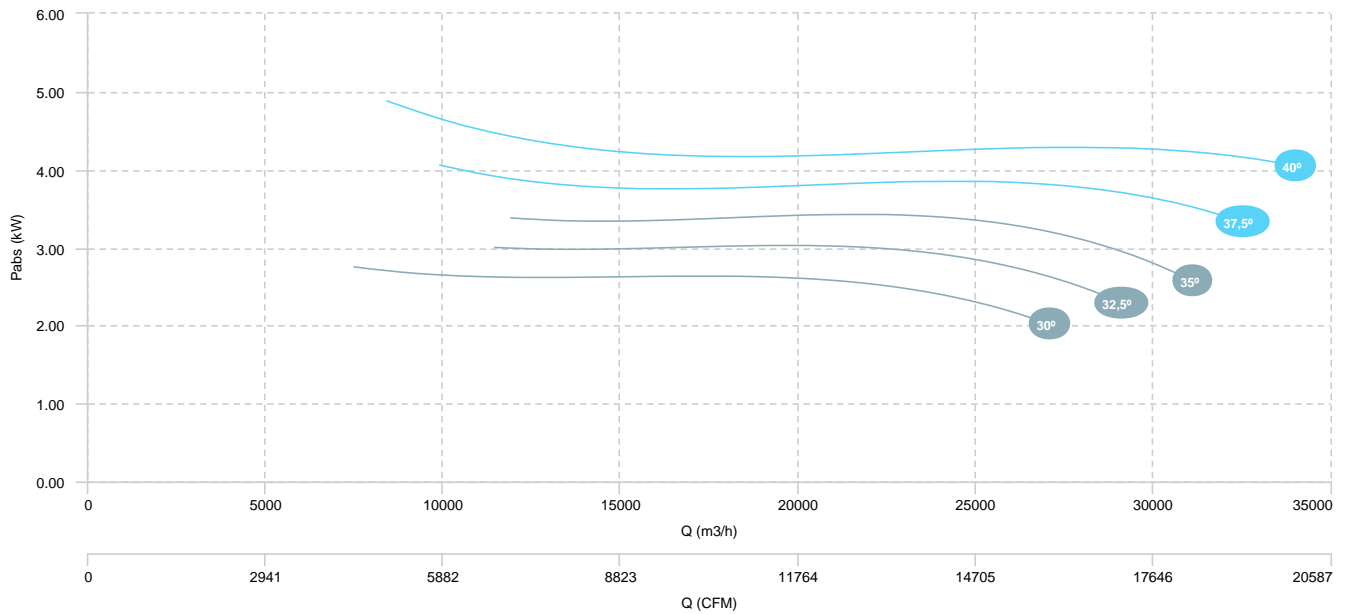

HC 80 T4/T6 3/0,9kW (A5:6)

HC 80 T4/T6 4/1,1kW (A5:6)

AIR FLOW - PRESSURE (6 POLES)

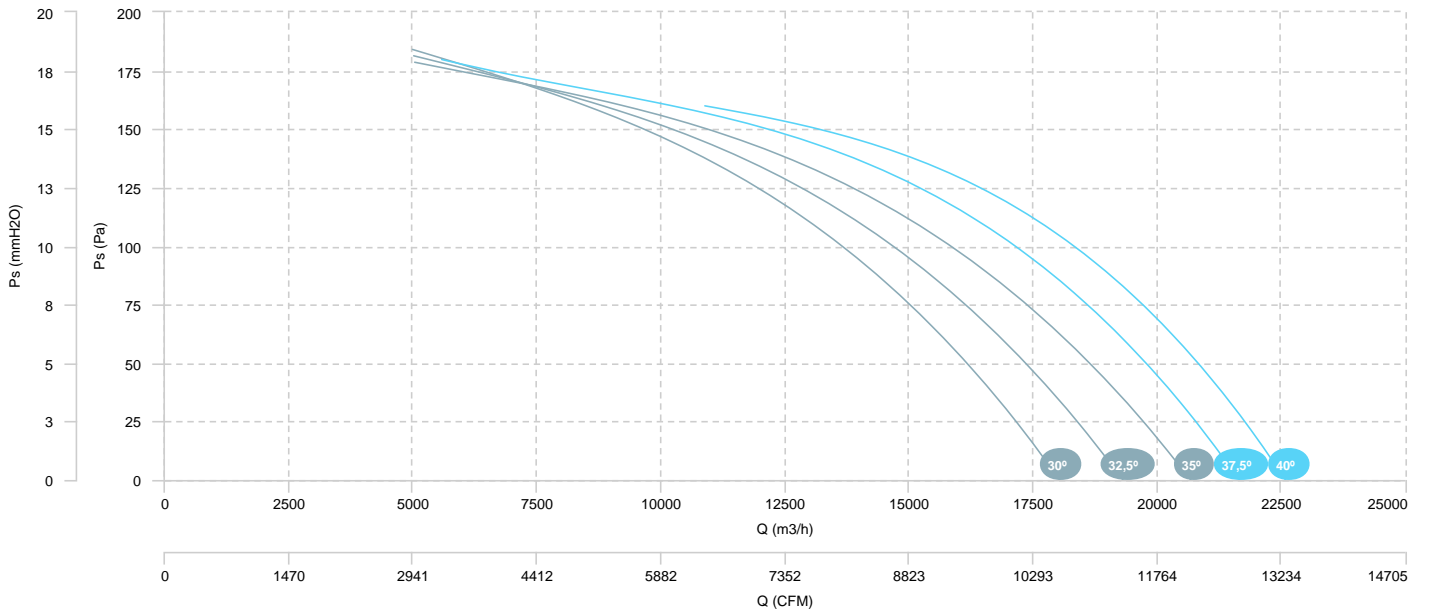

HC 80 T4/T6 1,1/0,37kW (A2:6)	HC 80 T4/T6 1,5/0,5kW (A2:6)	HC 80 T4/T6 2,2/0,6kW (A2:6)
HC 80 T4/T6 3/0,9kW (A2:6)	HC 80 T4/T6 4/1,1kW (A2:6)	HC 80 T4/T6 5,5/1,85kW (A2:6)

AIR FLOW - PRESSURE (4 POLES)

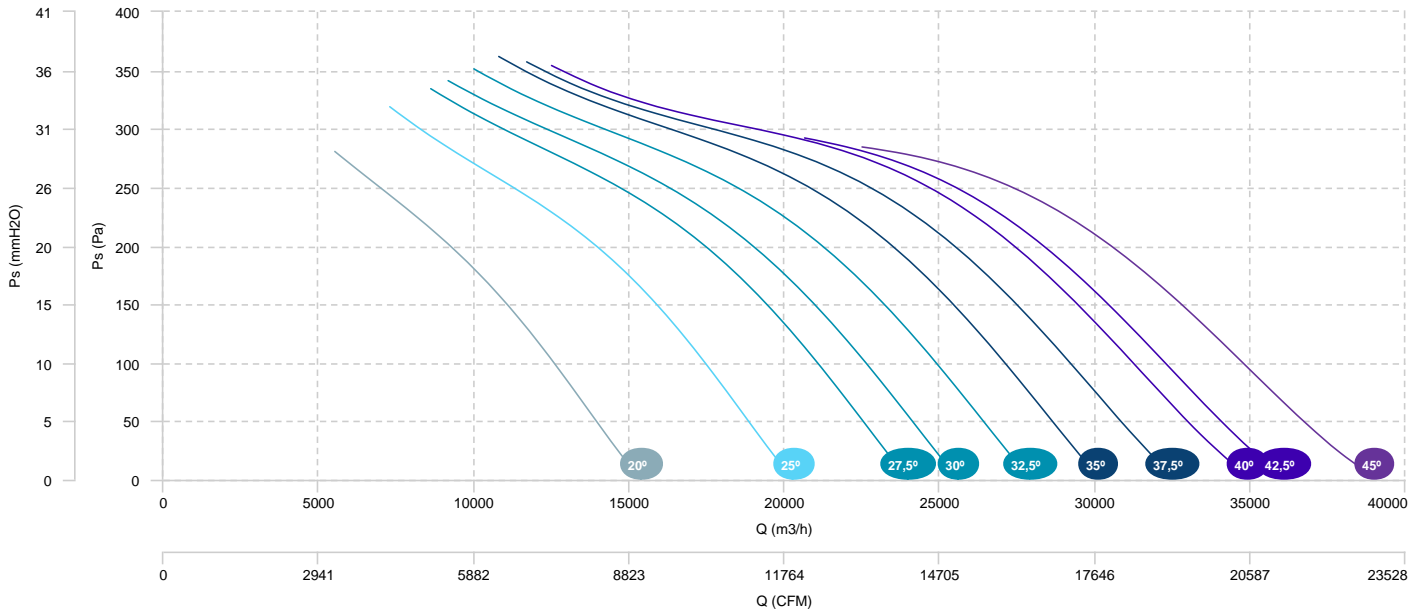

AIR FLOW - ABSORBED POWER (4 POLES)

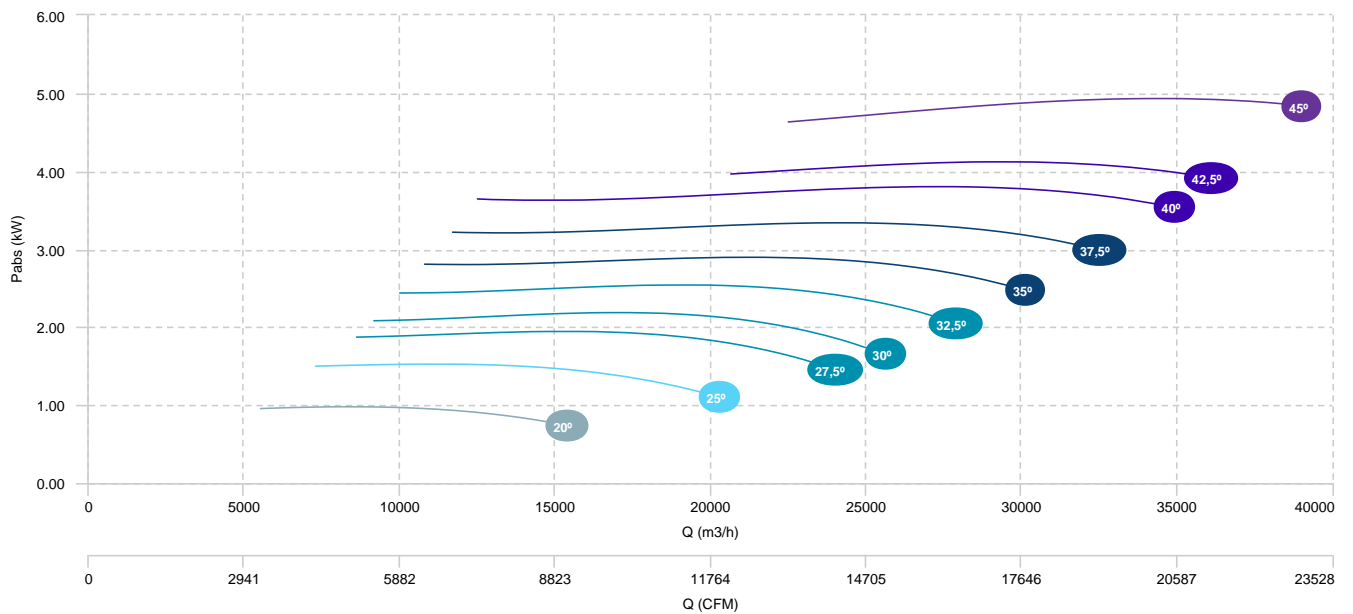

HC 80 T4/T6 1,1/0,37kW (A2:6)	HC 80 T4/T6 1,5/0,5kW (A2:6)	HC 80 T4/T6 2,2/0,6kW (A2:6)
HC 80 T4/T6 3/0,9kW (A2:6)	HC 80 T4/T6 4/1,1kW (A2:6)	HC 80 T4/T6 5,5/1,85kW (A2:6)

AIR FLOW - PRESSURE (6 POLES)

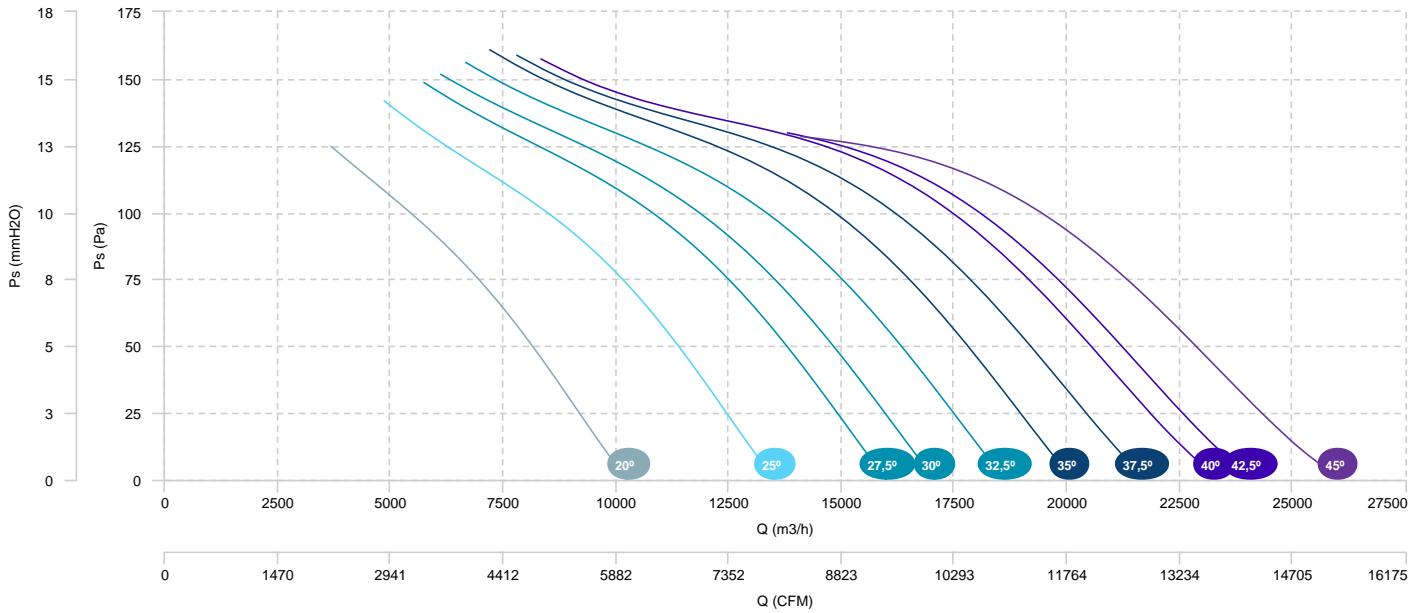

HC 80 T4/T6 1,5/0,5kW (A2:9)	HC 80 T4/T6 2,2/0,6kW (A2:9)	HC 80 T4/T6 3/0,9kW (A2:9)
HC 80 T4/T6 4/1,1kW (A2:9)	HC 80 T4/T6 5,5/1,85kW (A2:9)	

AIR FLOW - PRESSURE (4 POLES)

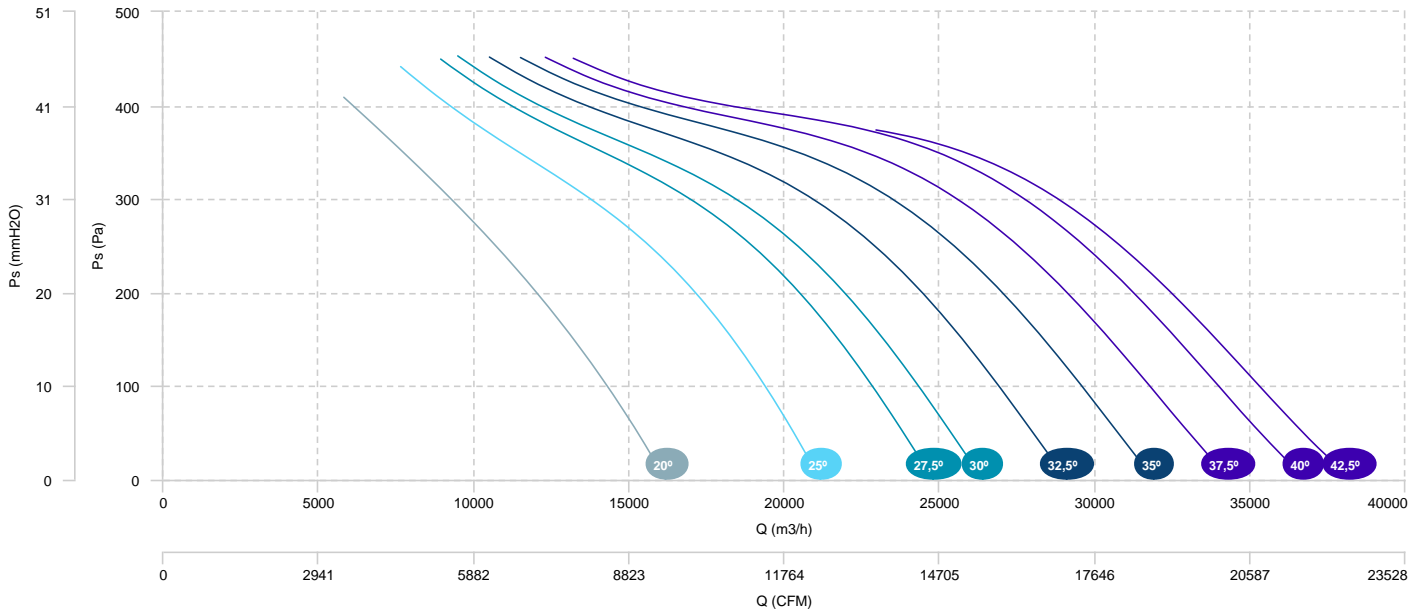

AIR FLOW - ABSORBED POWER (4 POLES)

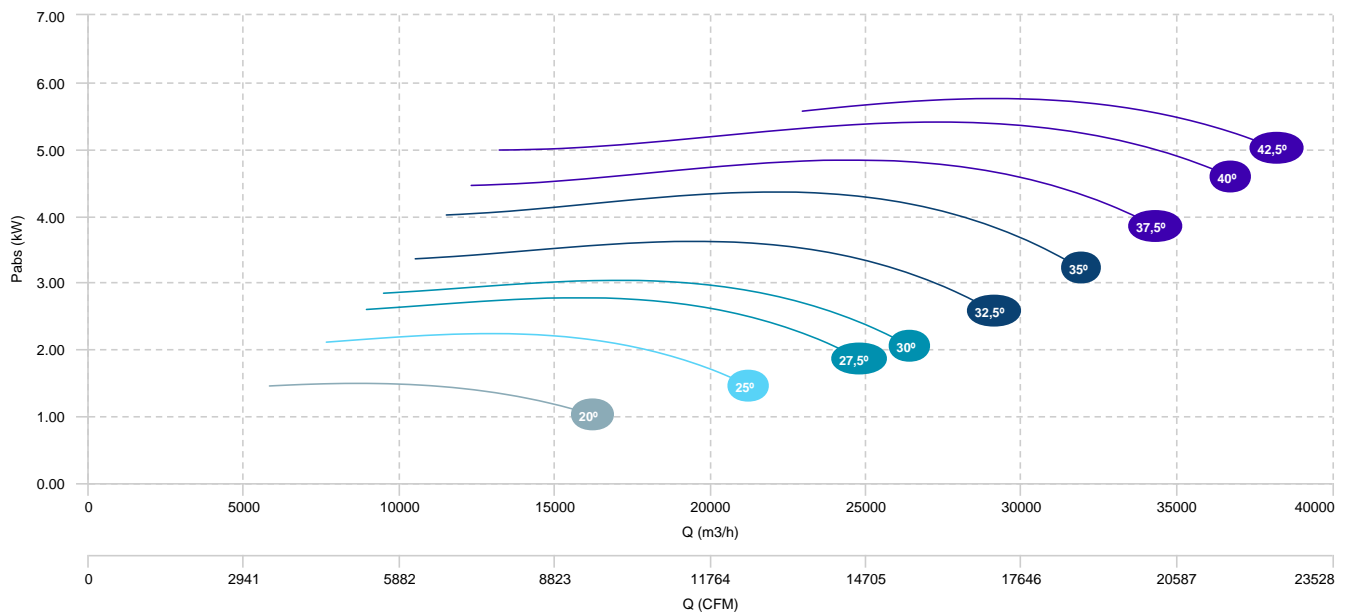

HC 80 T4/T6 1,5/0,5kW (A2:9)	HC 80 T4/T6 2,2/0,6kW (A2:9)	HC 80 T4/T6 3/0,9kW (A2:9)
HC 80 T4/T6 4/1,1kW (A2:9)	HC 80 T4/T6 5,5/1,85kW (A2:9)	

AIR FLOW - PRESSURE (6 POLES)

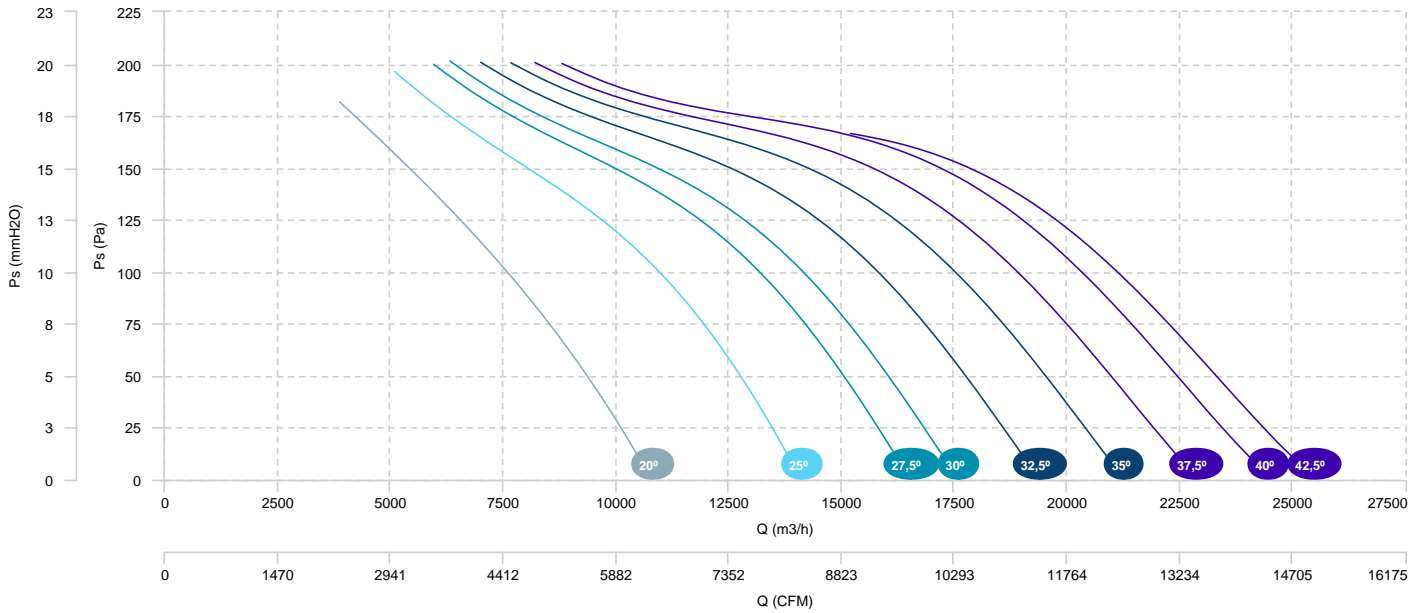

HC 80 T4/T8 3/0,55kW (A5:6)

HC 80 T4/T8 4/0,75kW (A5:6)

AIR FLOW - PRESSURE (4 POLES)

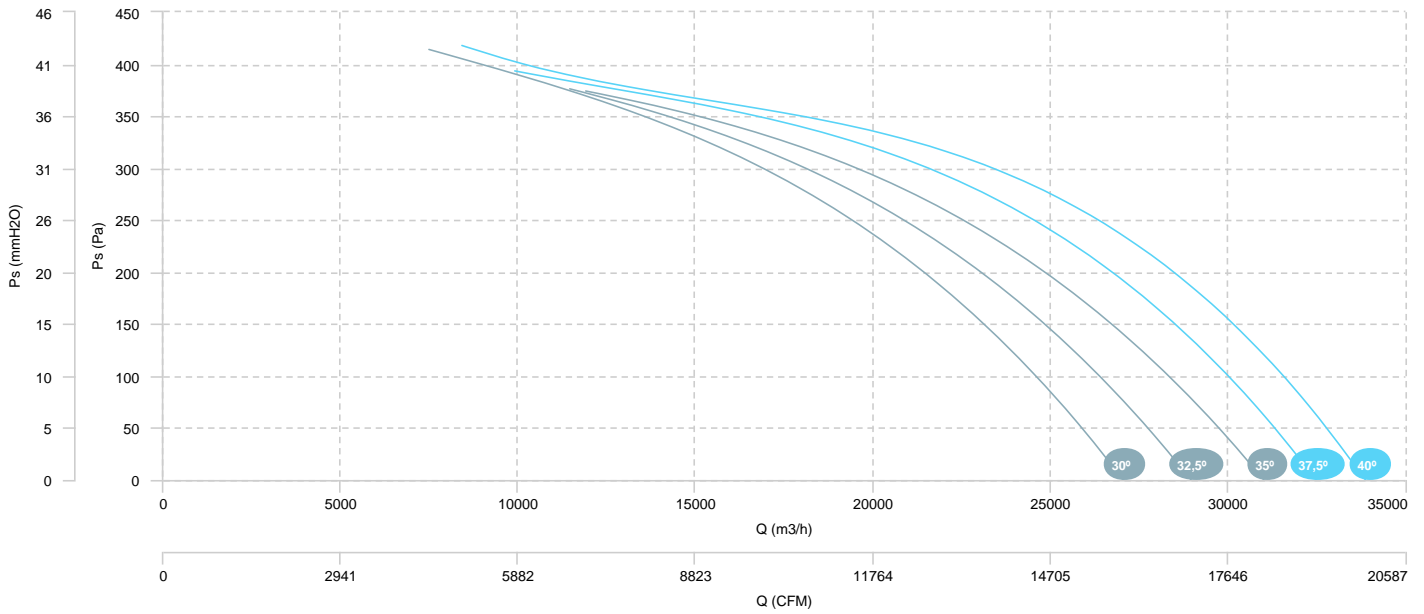

AIR FLOW - ABSORBED POWER (4 POLES)

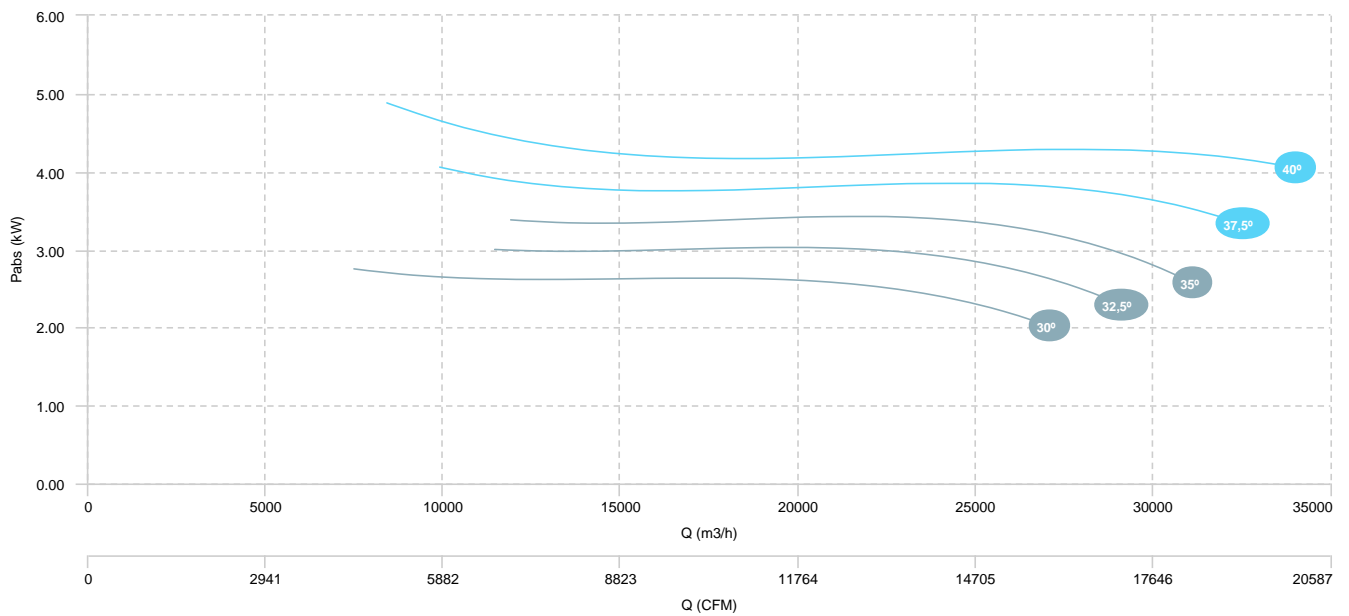

HC 80 T4/T8 3/0,55kW (A5:6)

HC 80 T4/T8 4/0,75kW (A5:6)

AIR FLOW - PRESSURE (8 POLES)

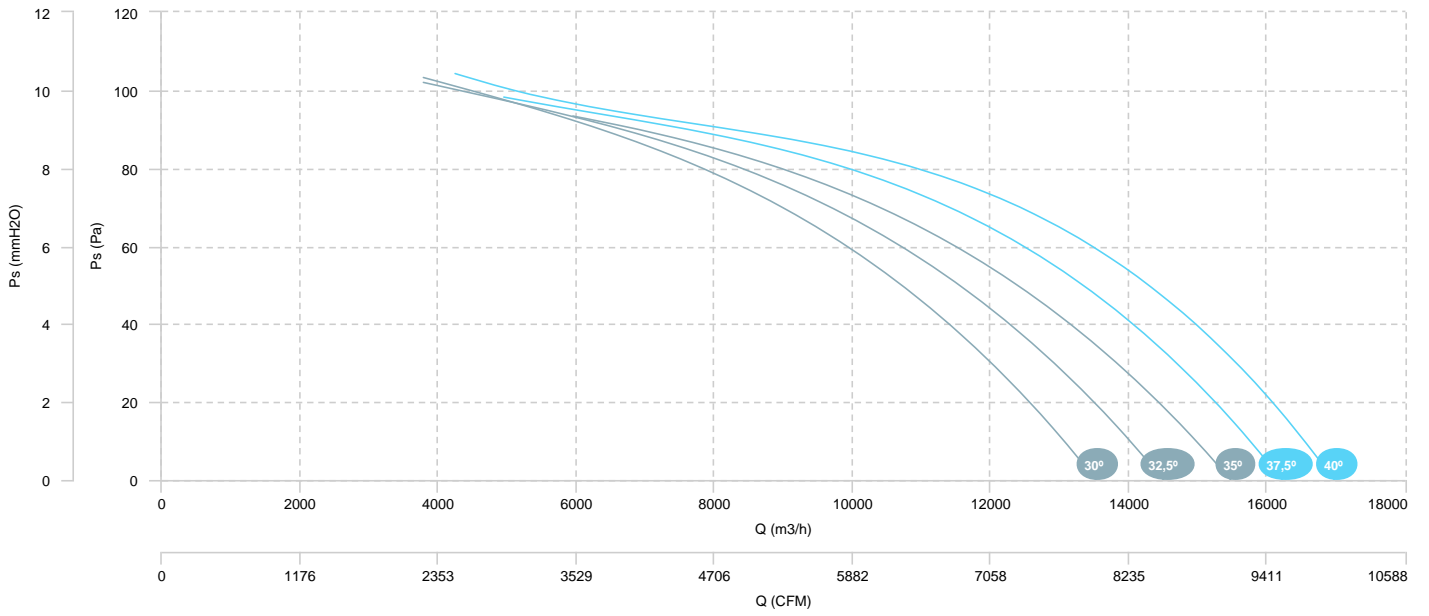

HC 80 T4/T8 1,5/0,25kW (A2:9)	HC 80 T4/T8 2,2/0,37kW (A2:9)	HC 80 T4/T8 3/0,55kW (A2:9)
HC 80 T4/T8 4/0,75kW (A2:9)	HC 80 T4/T8 5,5/1,1kW (A2:9)	

AIR FLOW - PRESSURE (4 POLES)

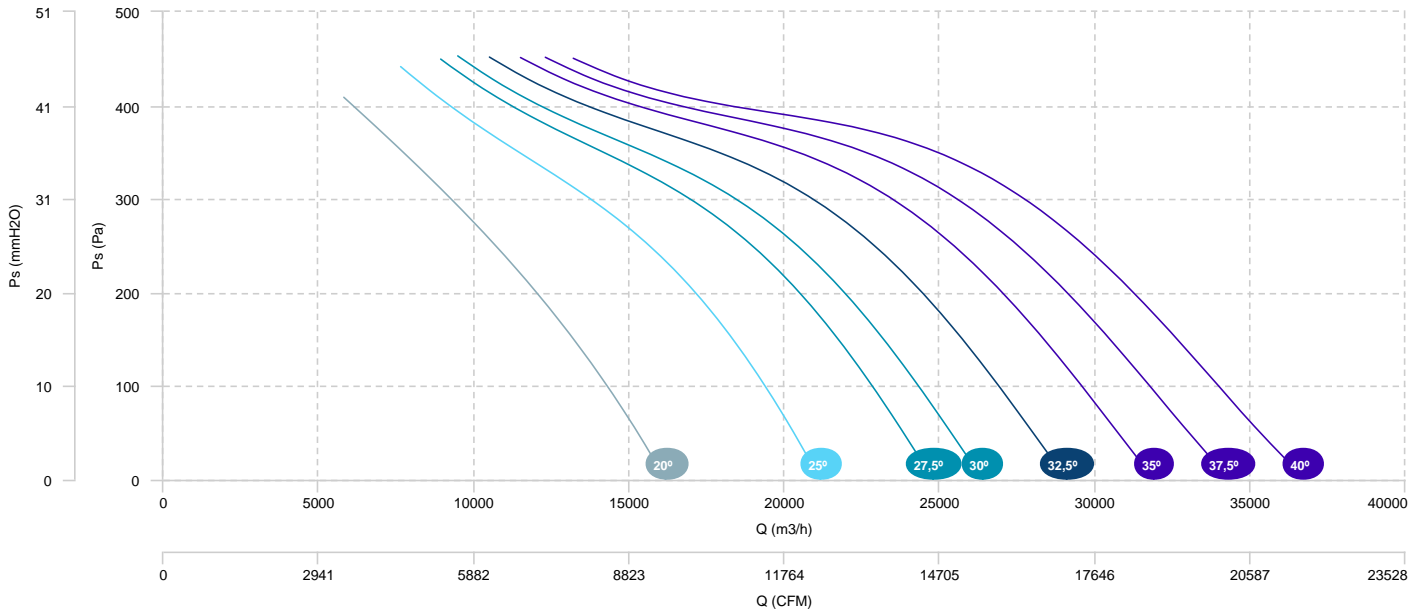

AIR FLOW - ABSORBED POWER (4 POLES)

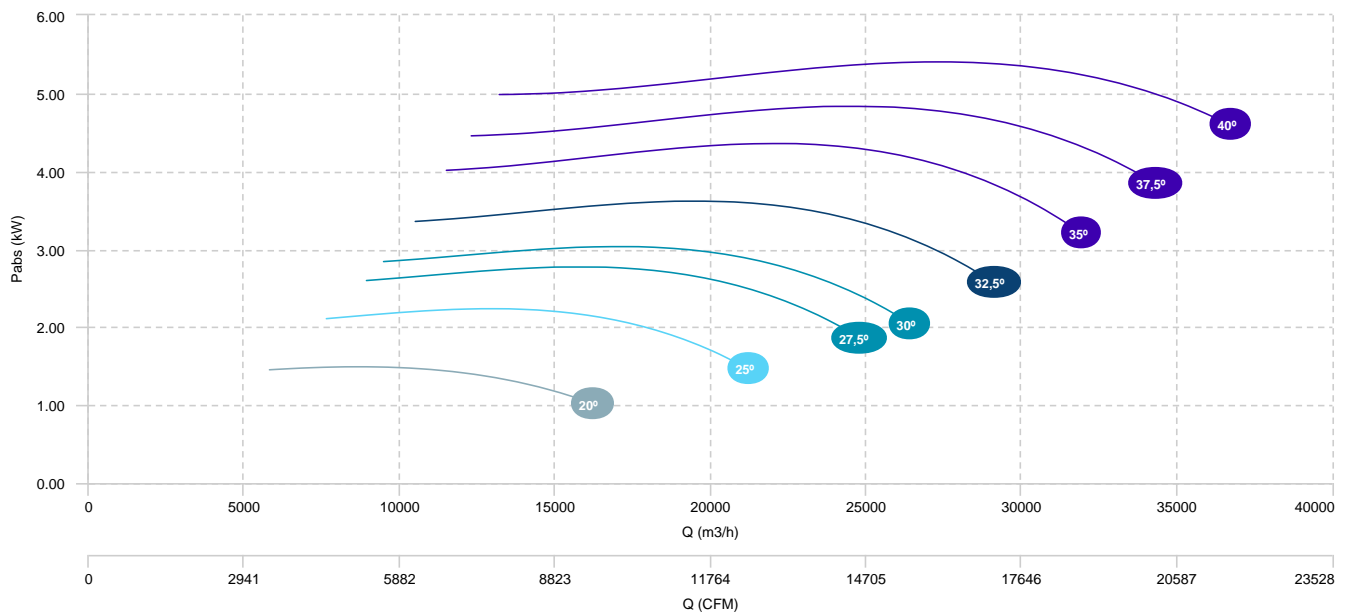

HC 80 T4/T8 1,5/0,25kW (A2:9)	HC 80 T4/T8 2,2/0,37kW (A2:9)	HC 80 T4/T8 3/0,55kW (A2:9)
HC 80 T4/T8 4/0,75kW (A2:9)	HC 80 T4/T8 5,5/1,1kW (A2:9)	

AIR FLOW - PRESSURE (8 POLES)

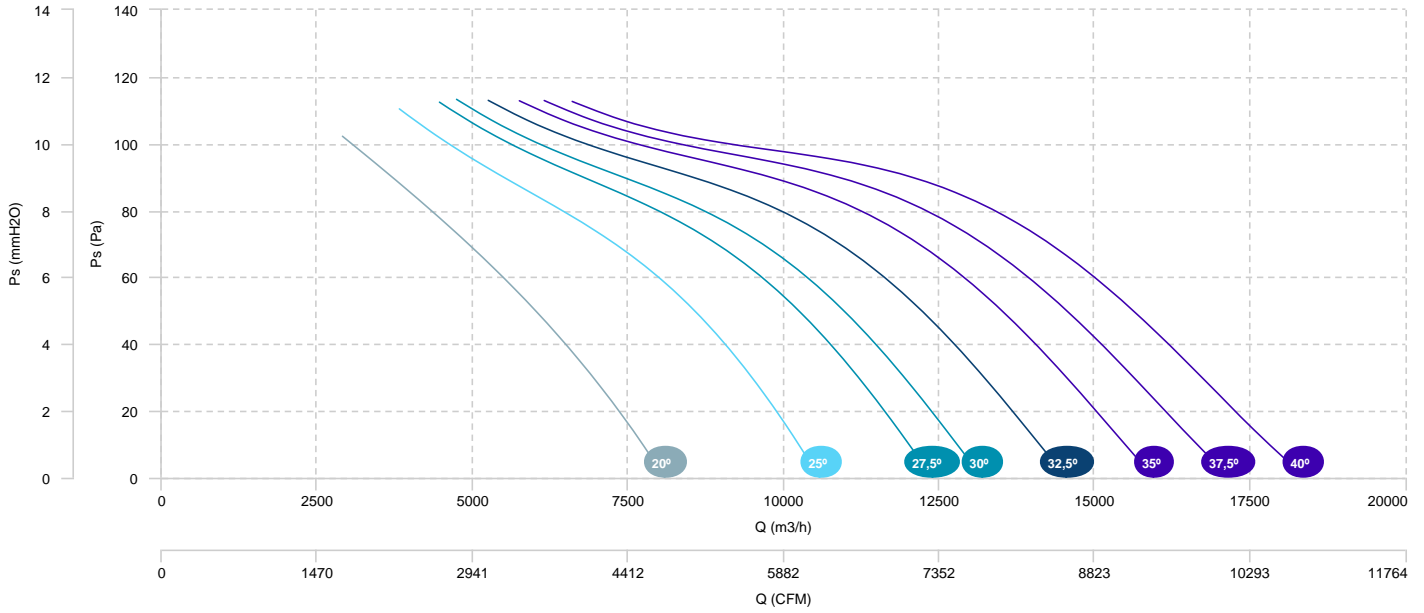

HC 80 T4/T8 1,1/0,18kW (A2:6)	HC 80 T4/T8 1,5/0,25kW (A2:6)	HC 80 T4/T8 2,2/0,37kW (A2:6)
HC 80 T4/T8 3/0,55kW (A2:6)	HC 80 T4/T8 4/0,75kW (A2:6)	HC 80 T4/T8 5,5/1,1kW (A2:6)

AIR FLOW - PRESSURE (4 POLES)

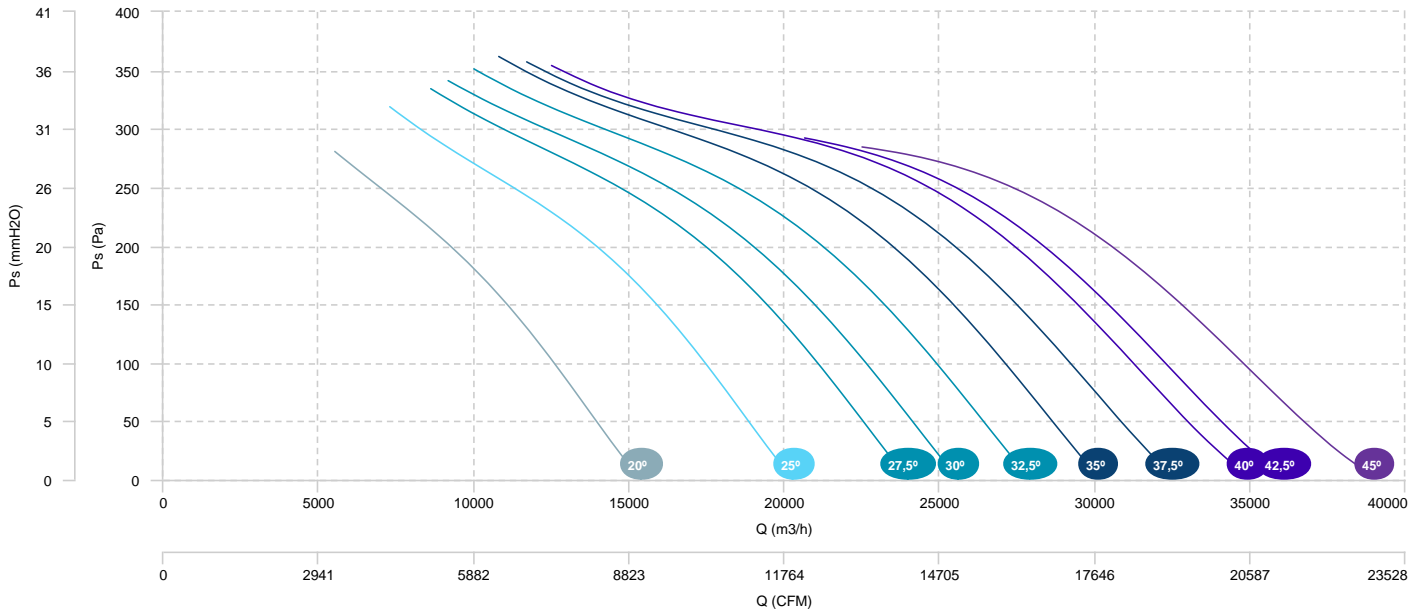

AIR FLOW - ABSORBED POWER (4 POLES)

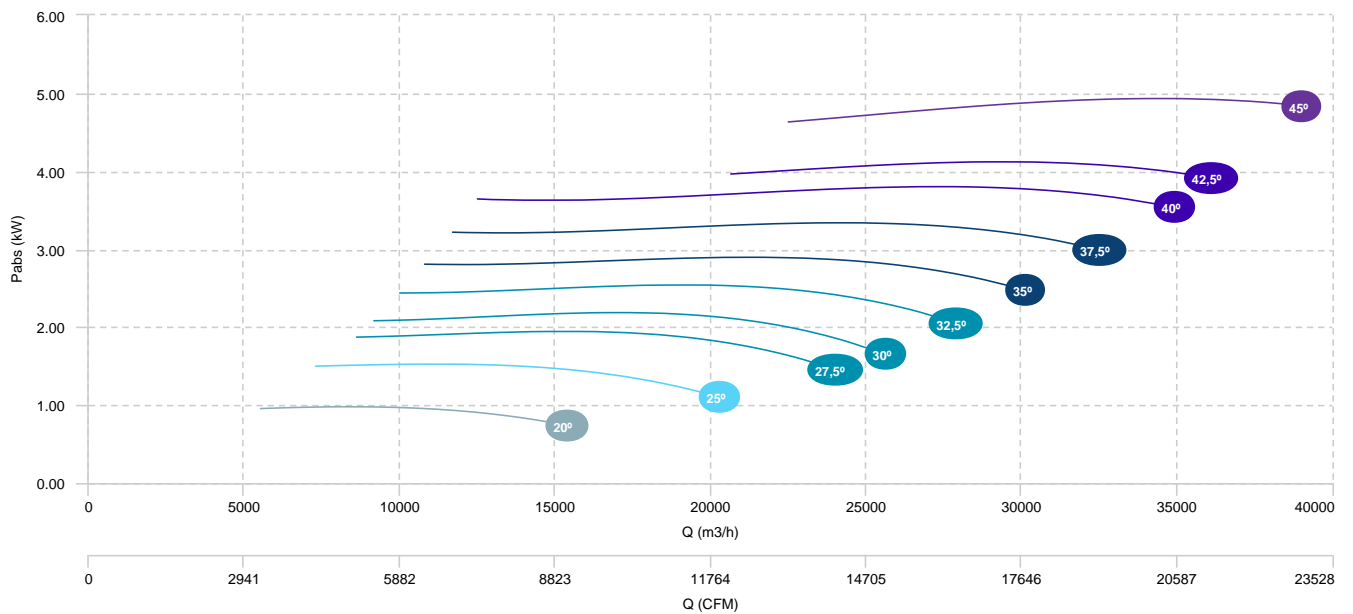

HC 80 T4/T8 1,1/0,18kW (A2:6)	HC 80 T4/T8 1,5/0,25kW (A2:6)	HC 80 T4/T8 2,2/0,37kW (A2:6)
HC 80 T4/T8 3/0,55kW (A2:6)	HC 80 T4/T8 4/0,75kW (A2:6)	HC 80 T4/T8 5,5/1,1kW (A2:6)

AIR FLOW - PRESSURE (8 POLES)

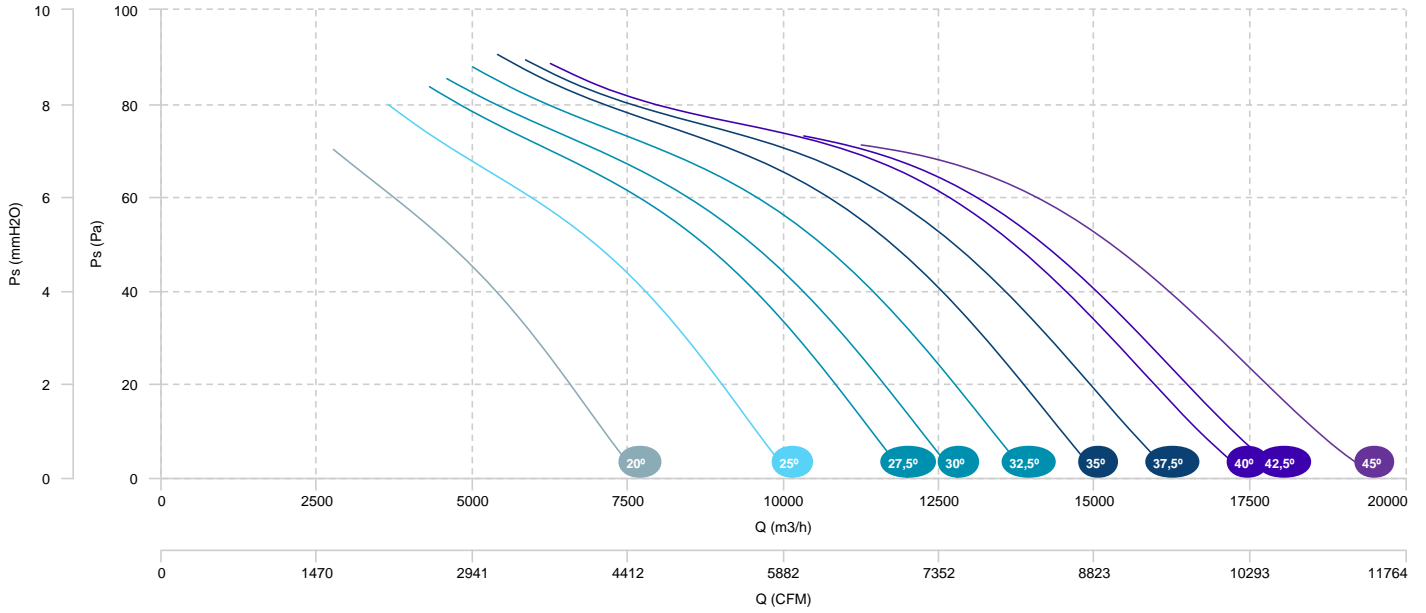

- HC 90 T4 5,5kW (A6:6)
- HC 90 T4 7,5kW (A6:6)
- HC 90 T4 11kW (A6:6)
- HC 90 T4 15kW (A6:6)

AIR FLOW - PRESSURE

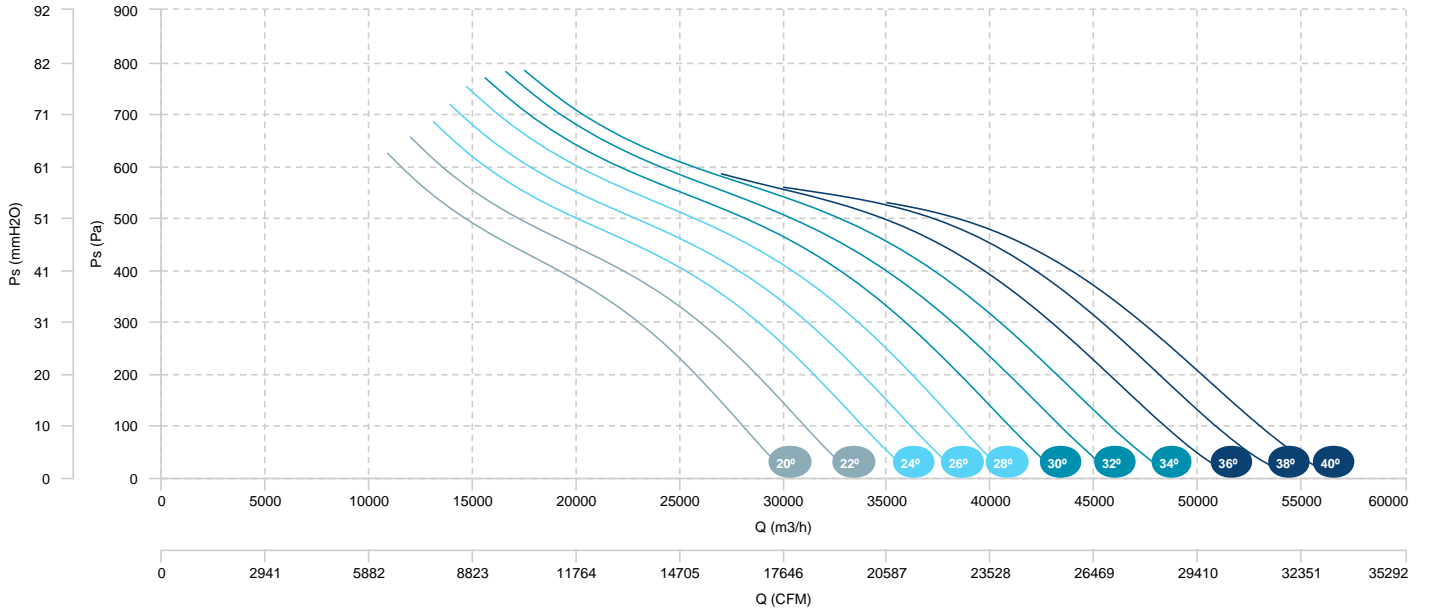

AIR FLOW - ABSORBED POWER

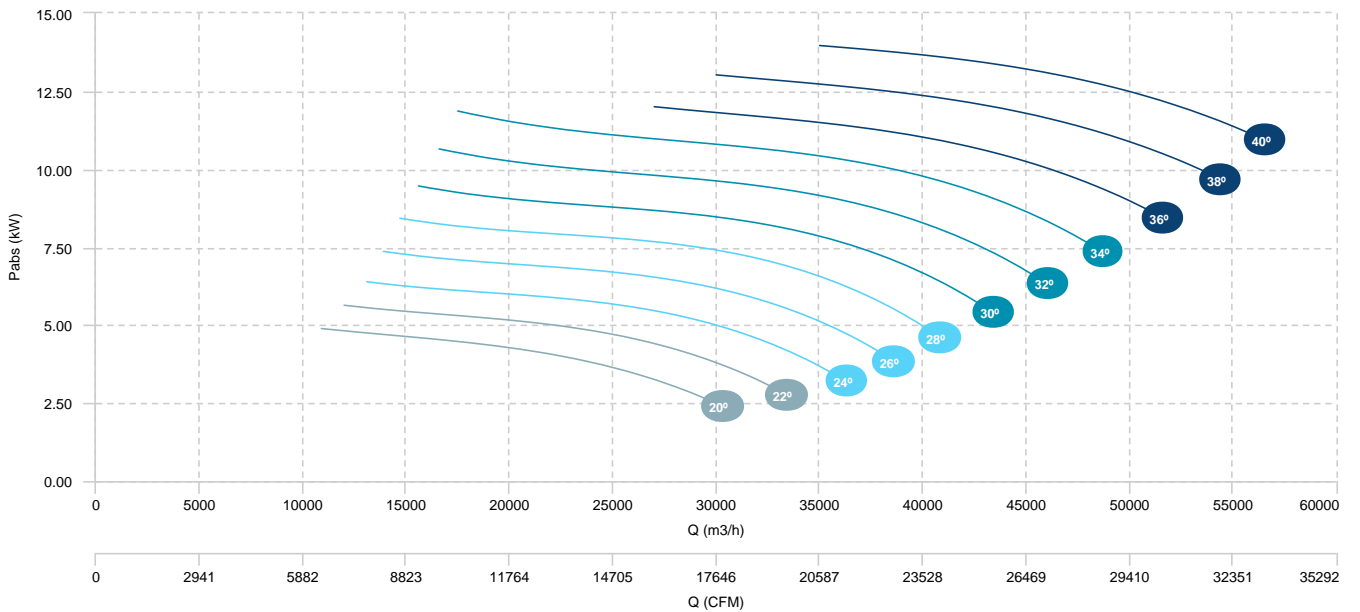

HC 90 T4 3kW (A6:3)	HC 90 T4 4kW (A6:3)	HC 90 T4 5,5kW (A6:3)
HC 90 T4 7,5kW (A6:3)	HC 90 T4 11kW (A6:3)	

AIR FLOW - PRESSURE

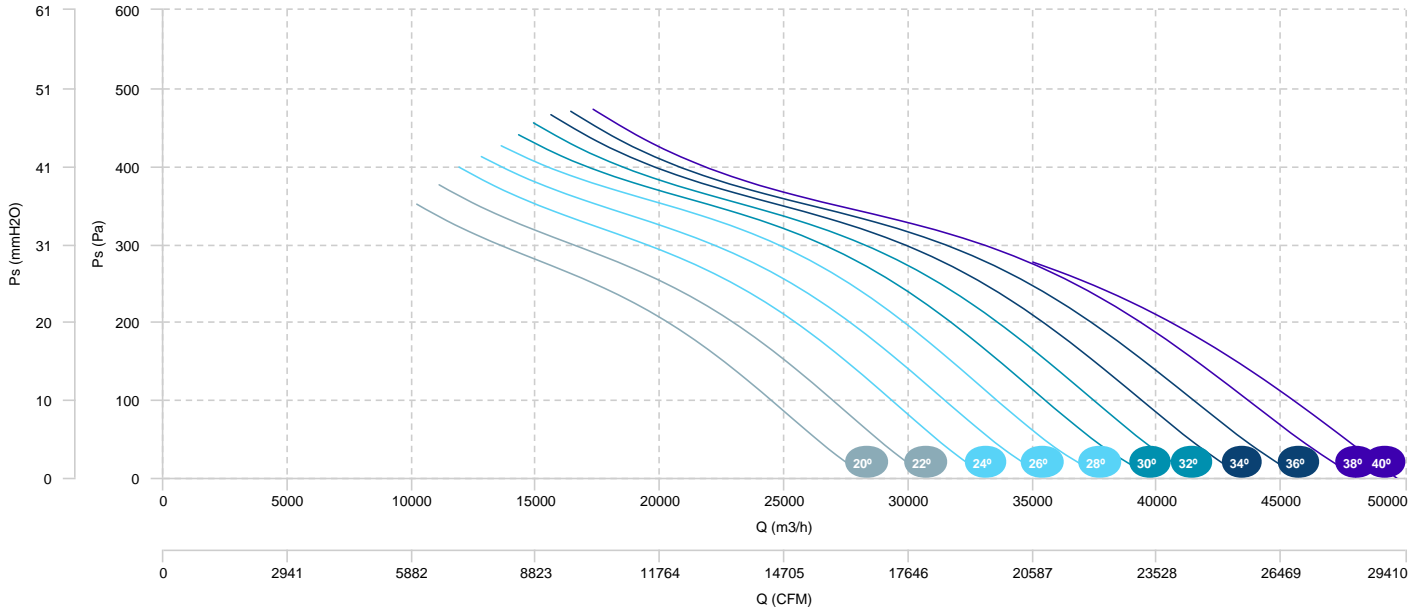

AIR FLOW - ABSORBED POWER

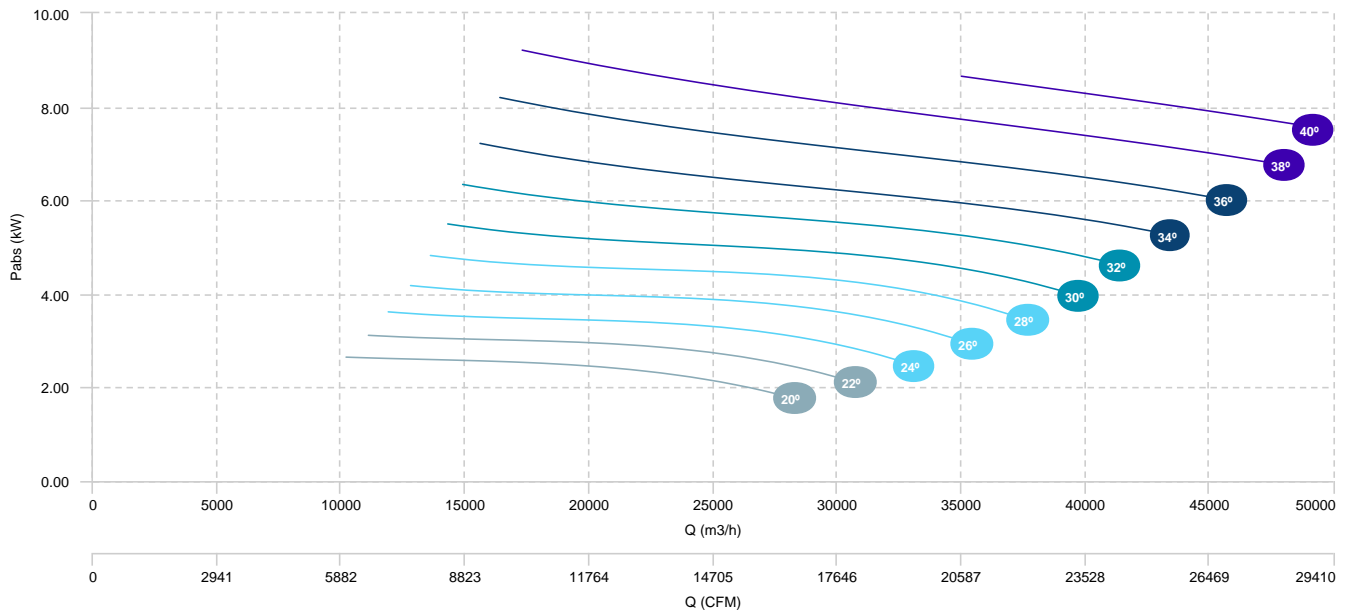

HC 90 T6 1,5kW (A6:3)

HC 90 T6 2,2kW (A6:3)

HC 90 T6 3kW (A6:3)

AIR FLOW - PRESSURE

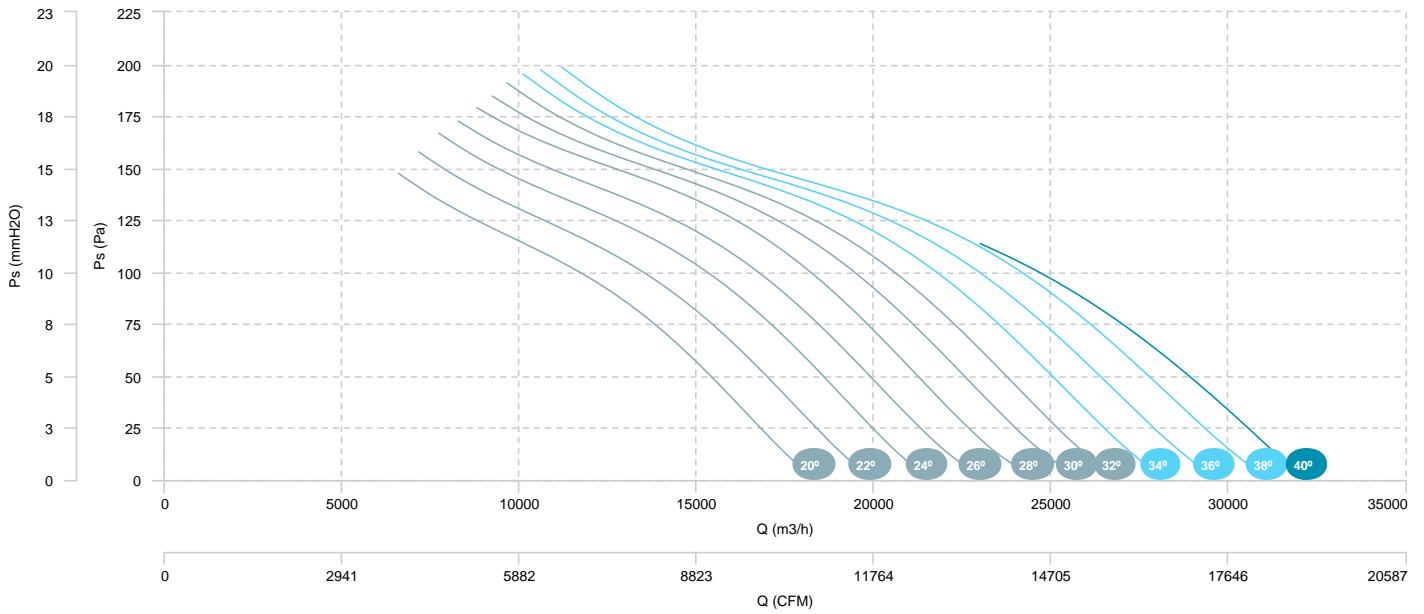

AIR FLOW - ABSORBED POWER

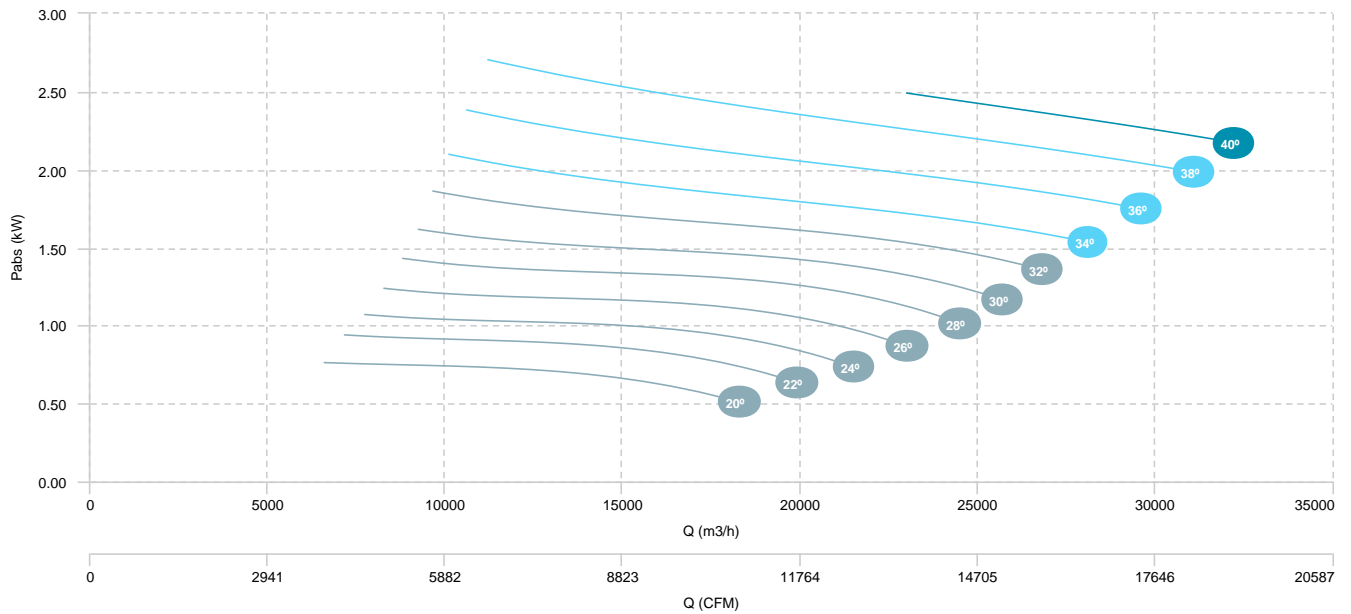

- HC 90 T6 1,5kW (A6:6)
- HC 90 T6 2,2kW (A6:6)
- HC 90 T6 3kW (A6:6)
- HC 90 T6 4kW (A6:6)

AIR FLOW - PRESSURE

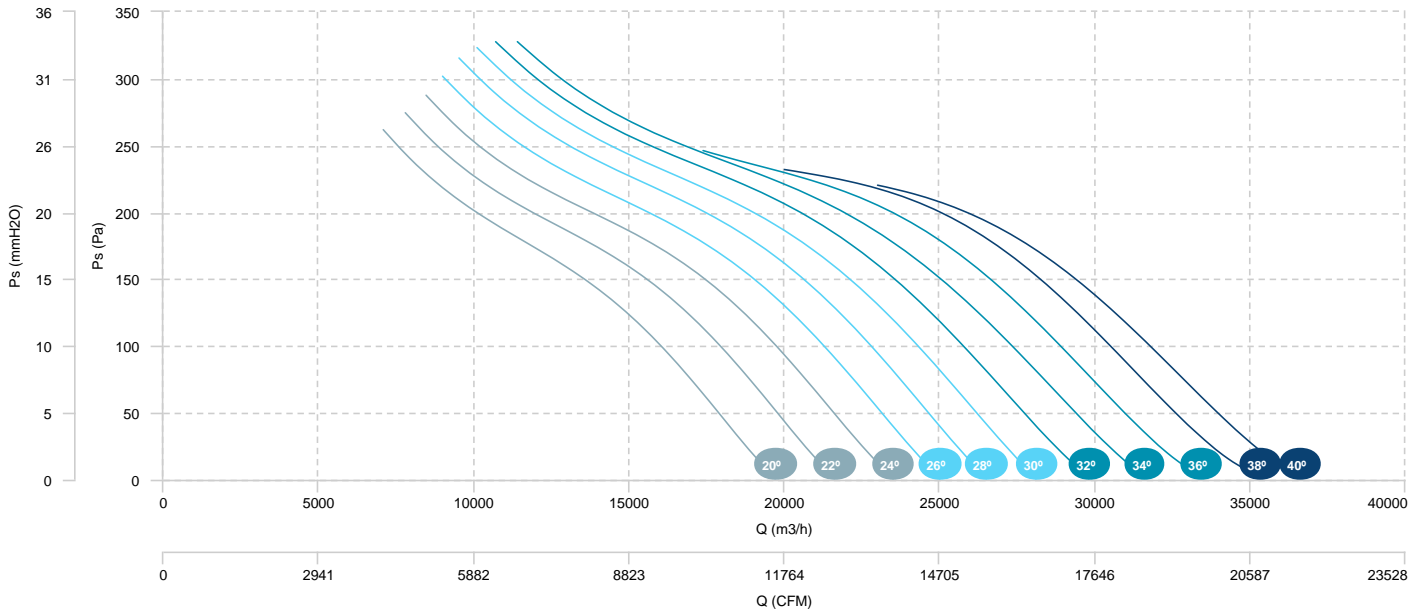

AIR FLOW - ABSORBED POWER

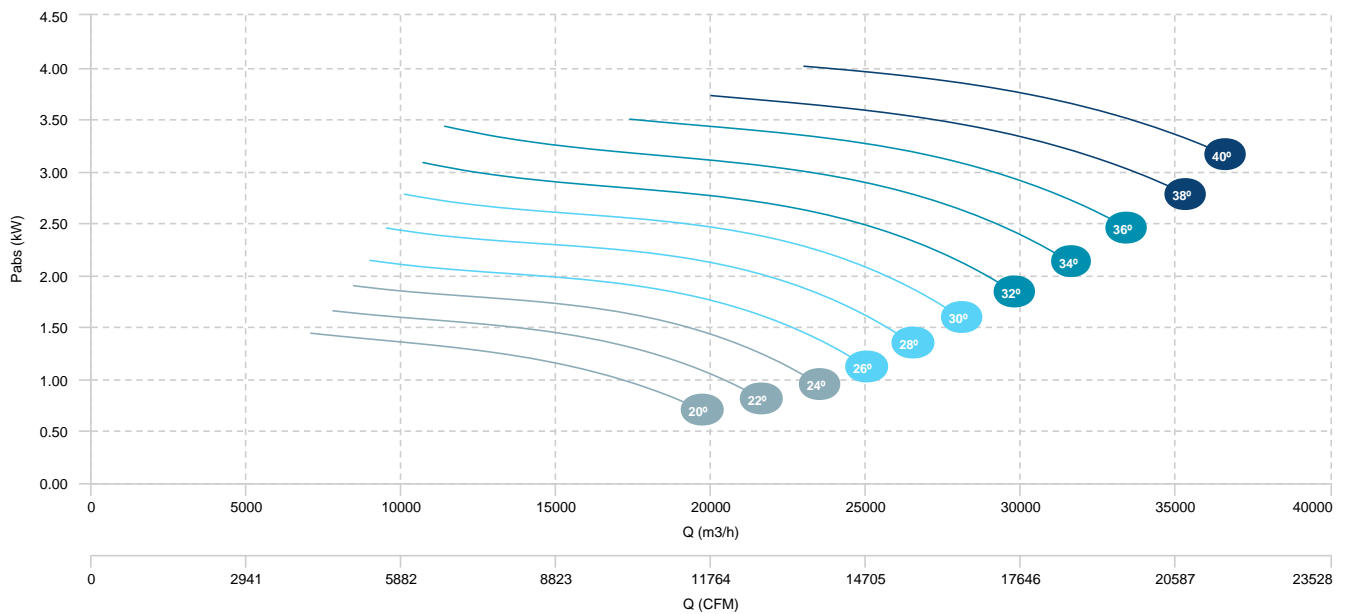

HC 90 T4/T6 5,5/1,85kW (A6:6)
 HC 90 T4/T6 15/4,4kW (A6:6)

HC 90 T4/T6 7,5/2,2kW (A6:6)

HC 90 T4/T6 11/3,6kW (A6:6)

AIR FLOW - PRESSURE (4 POLES)

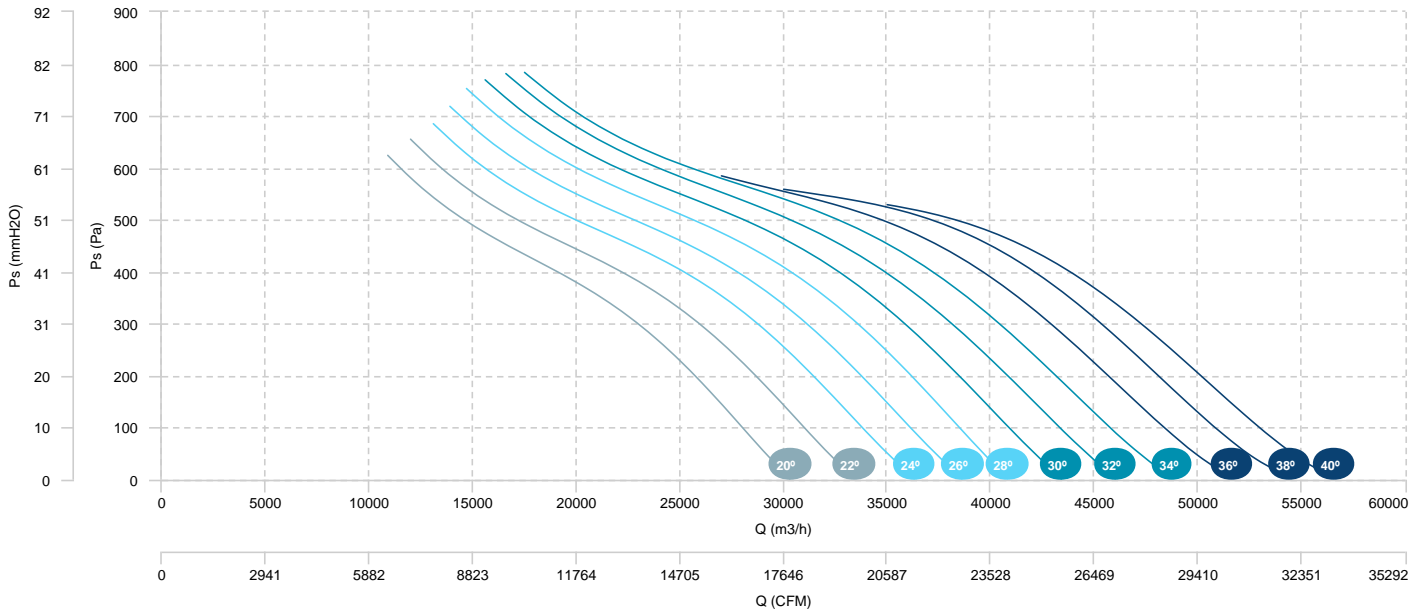

AIR FLOW - ABSORBED POWER (4 POLES)

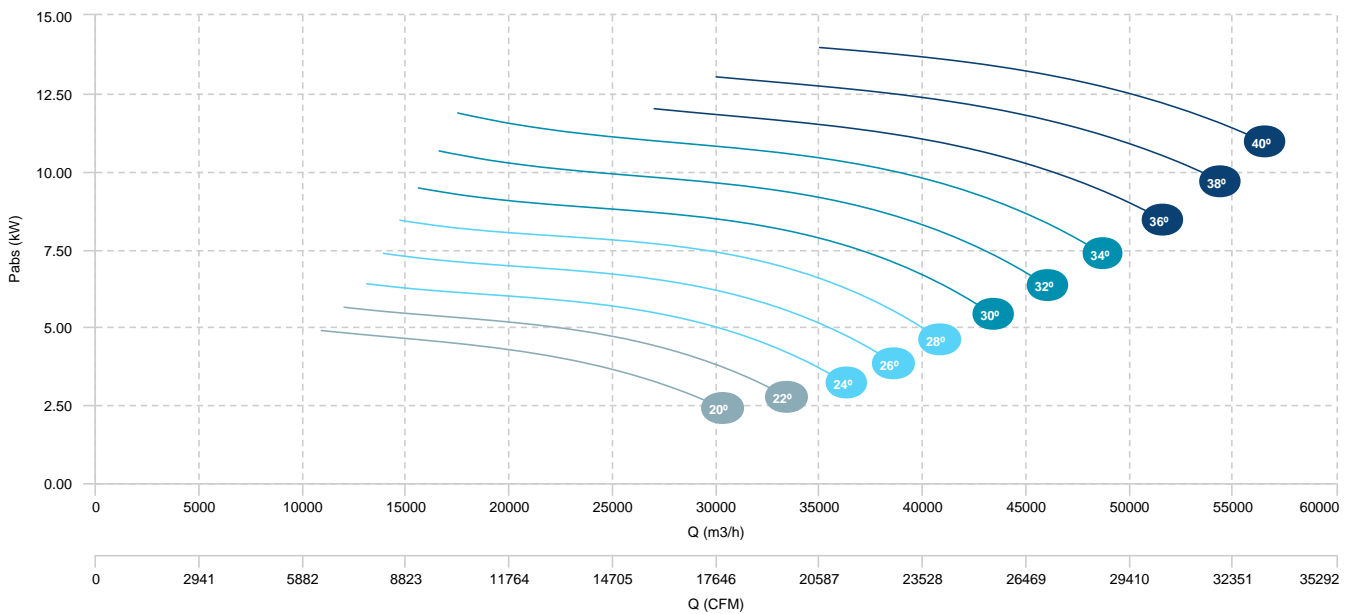

HC 90 T4/T6 5,5/1,85kW (A6:6)
 HC 90 T4/T6 15/4,4kW (A6:6)

HC 90 T4/T6 7,5/2,2kW (A6:6)

HC 90 T4/T6 11/3,6kW (A6:6)

AIR FLOW - PRESSURE (6 POLES)

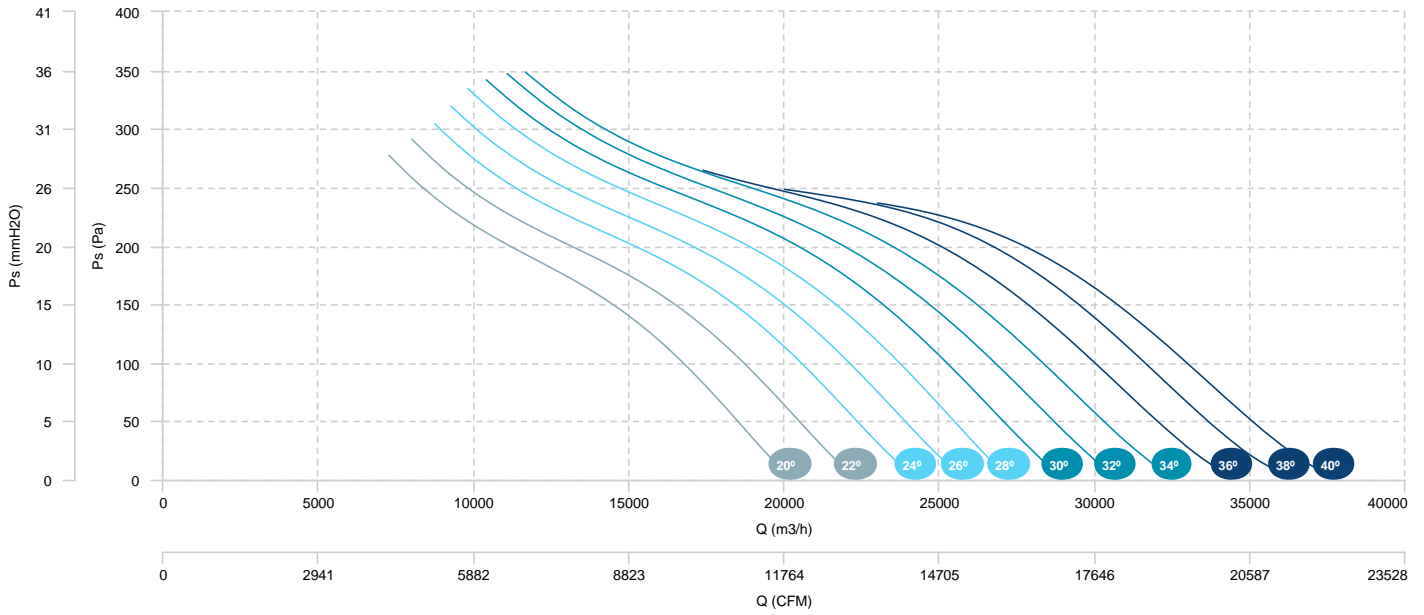

HC 90 T4/T6 3/0,9kW (A6:3)	HC 90 T4/T6 4/1,1kW (A6:3)	HC 90 T4/T6 5,5/1,85kW (A6:3)
HC 90 T4/T6 7,5/2,2kW (A6:3)	HC 90 T4/T6 11/3,6kW (A6:3)	

AIR FLOW - PRESSURE (4 POLES)

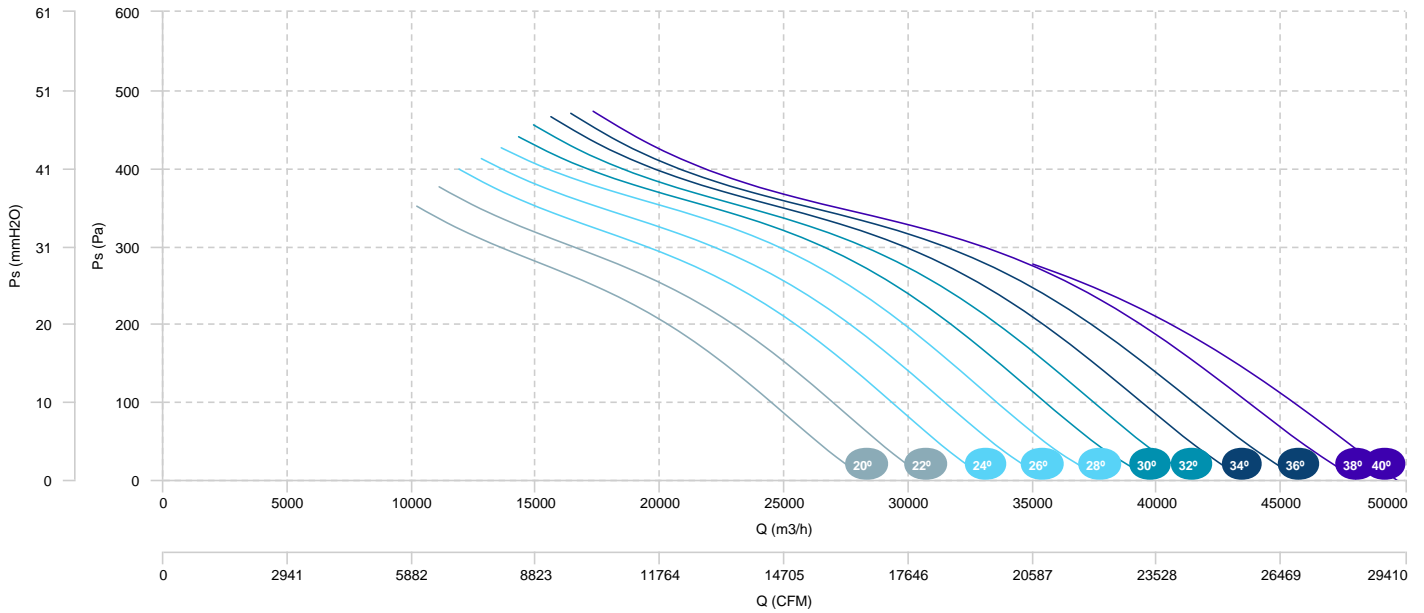

AIR FLOW - ABSORBED POWER (4 POLES)

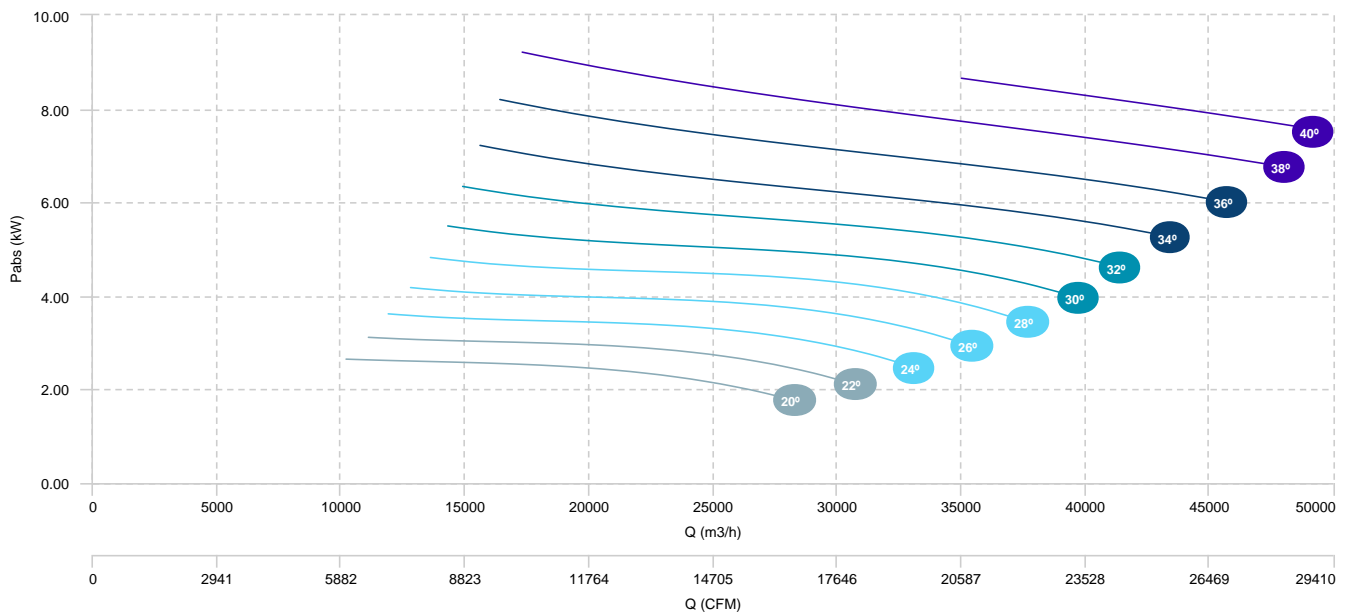

HC 90 T4/T6 3/0,9kW (A6:3)	HC 90 T4/T6 4/1,1kW (A6:3)	HC 90 T4/T6 5,5/1,85kW (A6:3)
HC 90 T4/T6 7,5/2,2kW (A6:3)	HC 90 T4/T6 11/3,6kW (A6:3)	

AIR FLOW - PRESSURE (6 POLES)

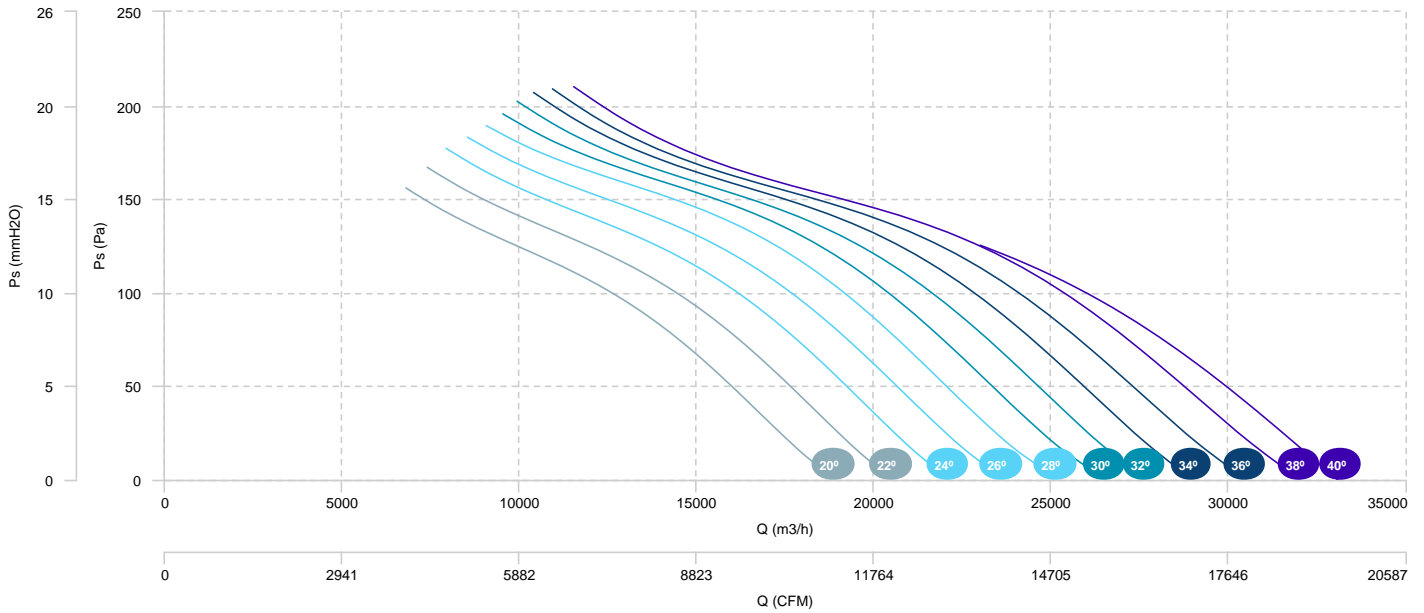

HC 90 T4/T8 5,5/1,1kW (A6:6)	HC 90 T4/T8 7,5/1,5kW (A6:6)	HC 90 T4/T8 11/3kW (A6:6)
HC 90 T4/T8 15/3,5kW (A6:6)		

AIR FLOW - PRESSURE (4 POLES)

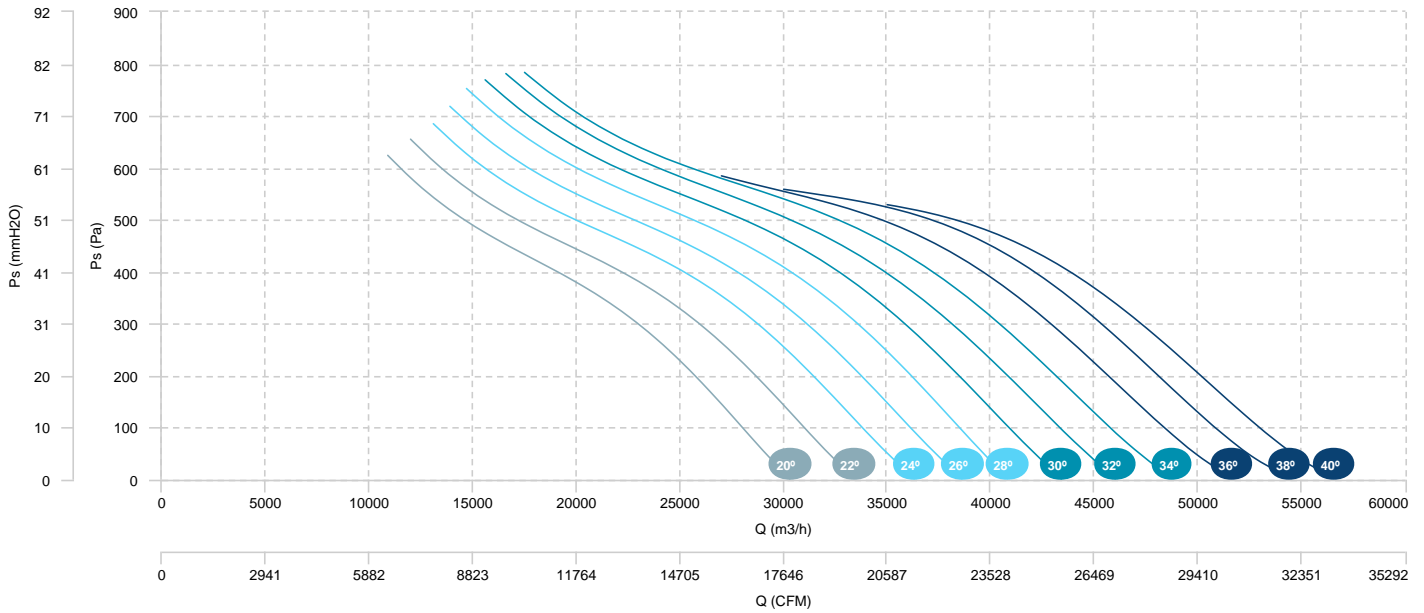

AIR FLOW - ABSORBED POWER (4 POLES)

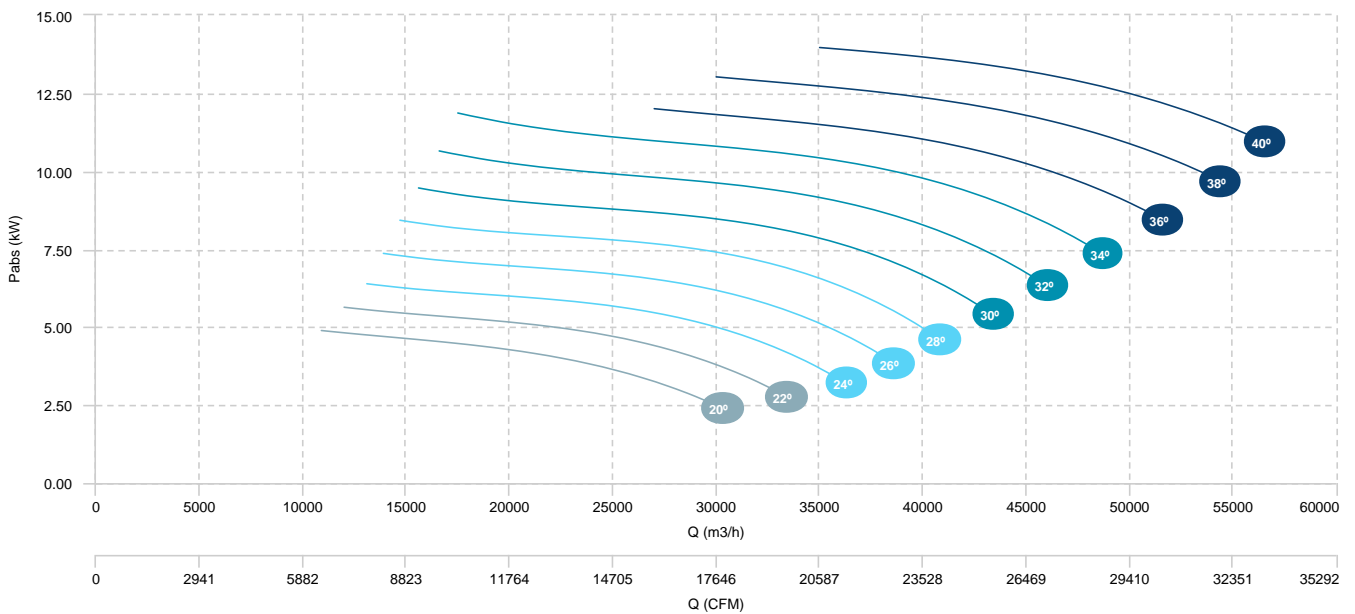

HC 90 T4/T8 5,5/1,1kW (A6:6)
 HC 90 T4/T8 15/3,5kW (A6:6)

HC 90 T4/T8 7,5/1,5kW (A6:6)

HC 90 T4/T8 11/3kW (A6:6)

AIR FLOW - PRESSURE (8 POLES)

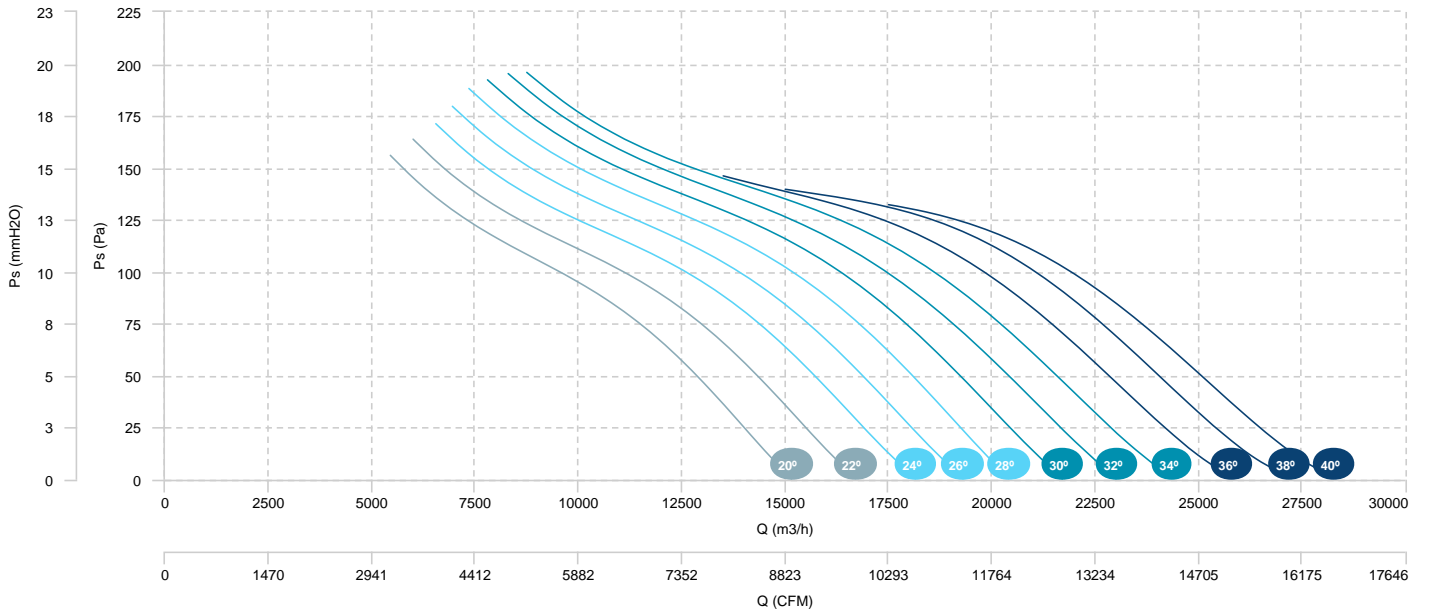

HC 90 T4/T8 3/0,55kW (A6:3)	HC 90 T4/T8 4/0,75kW (A6:3)	HC 90 T4/T8 5,5/1,1kW (A6:3)
HC 90 T4/T8 7,5/1,5kW (A6:3)	HC 90 T4/T8 11/3kW (A6:3)	

AIR FLOW - PRESSURE (4 POLES)

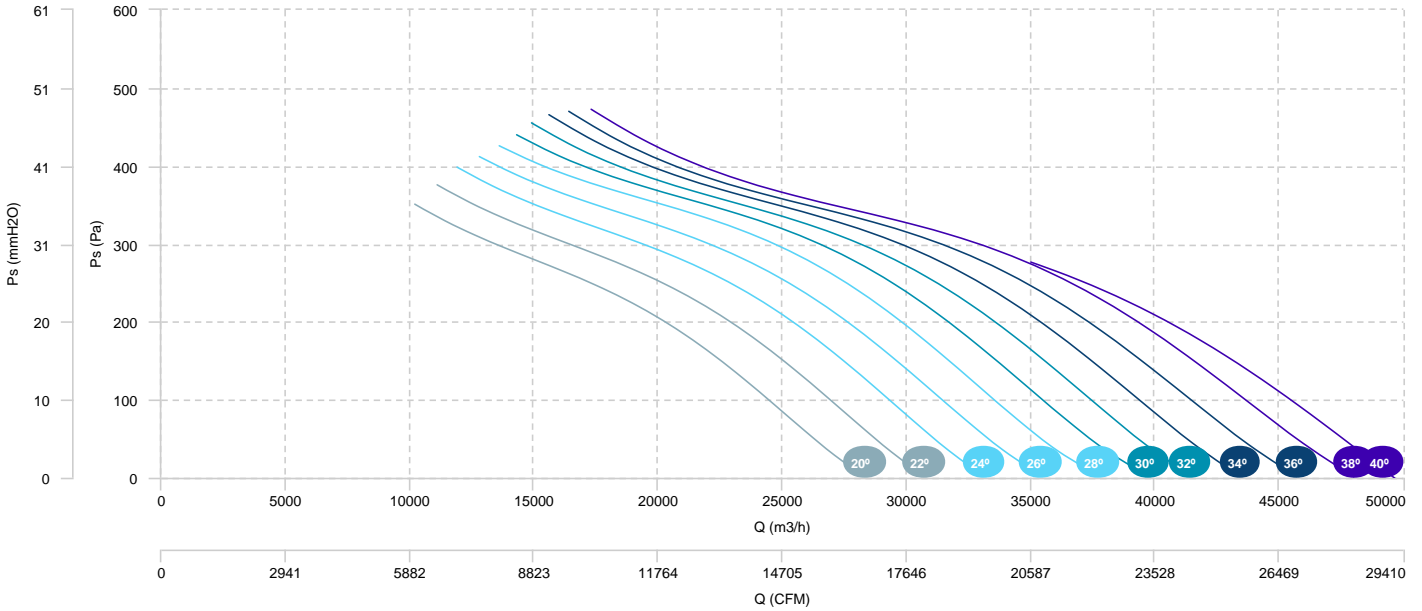

AIR FLOW - ABSORBED POWER (4 POLES)

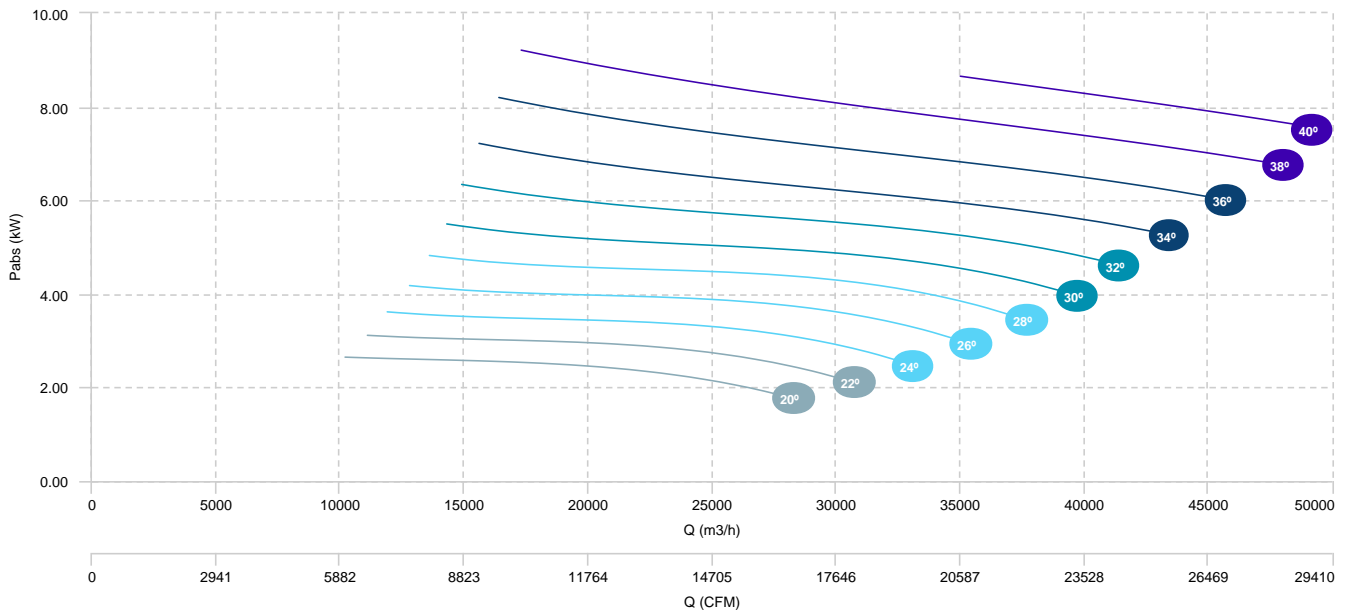

HC 90 T4/T8 3/0,55kW (A6:3)	HC 90 T4/T8 4/0,75kW (A6:3)	HC 90 T4/T8 5,5/1,1kW (A6:3)
HC 90 T4/T8 7,5/1,5kW (A6:3)	HC 90 T4/T8 11/3kW (A6:3)	

AIR FLOW - PRESSURE (8 POLES)

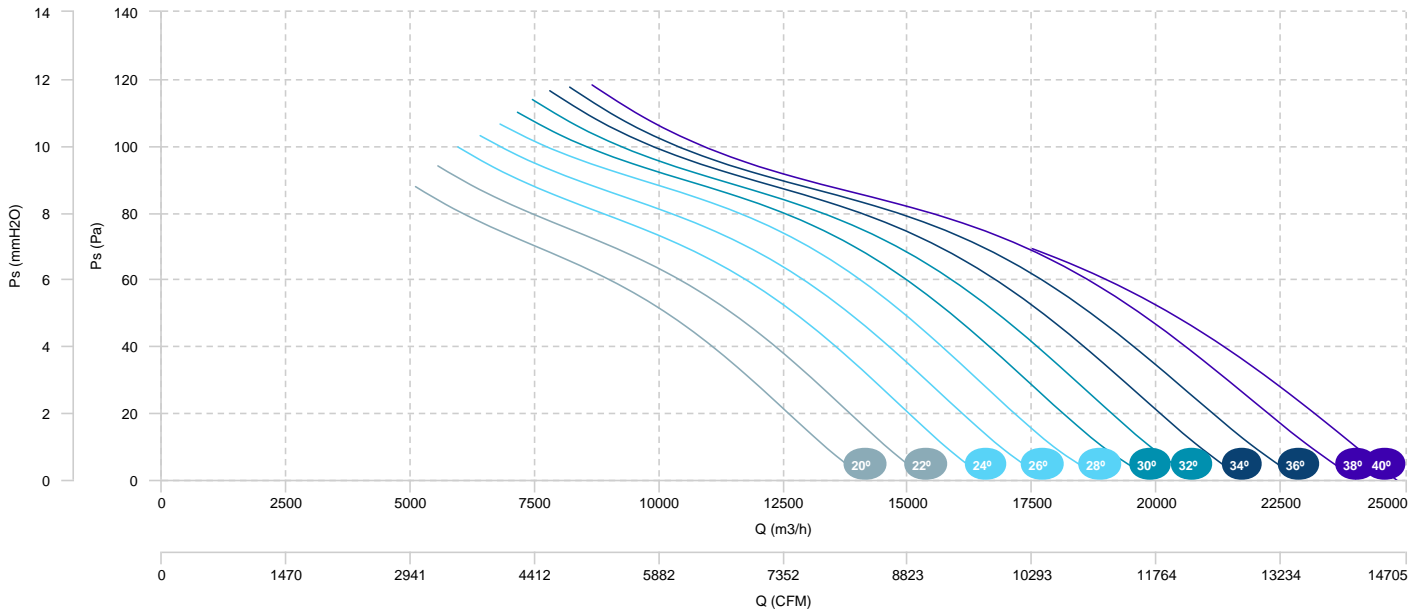

HC 100 T4 7,5kW (A6:6)	HC 100 T4 11kW (A6:6)	HC 100 T4 15kW (A6:6)
HC 100 T4 18,5kW (A6:6)	HC 100 T4 22kW (A6:6)	

AIR FLOW - PRESSURE

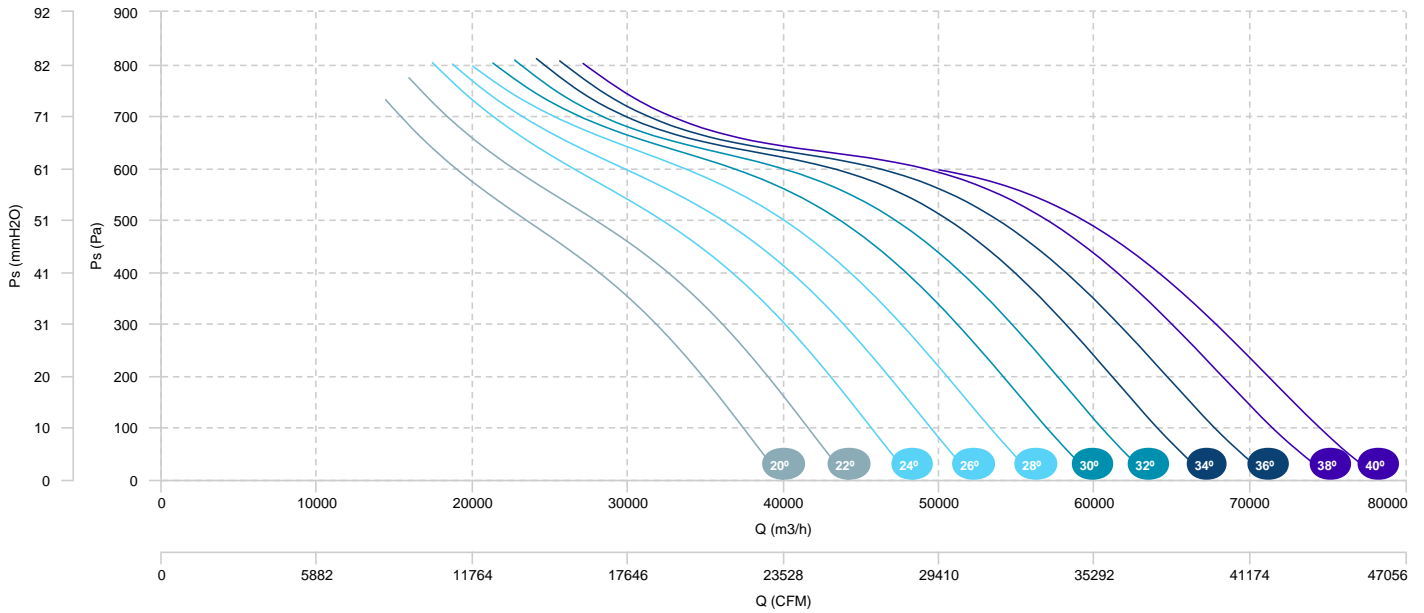

AIR FLOW - ABSORBED POWER

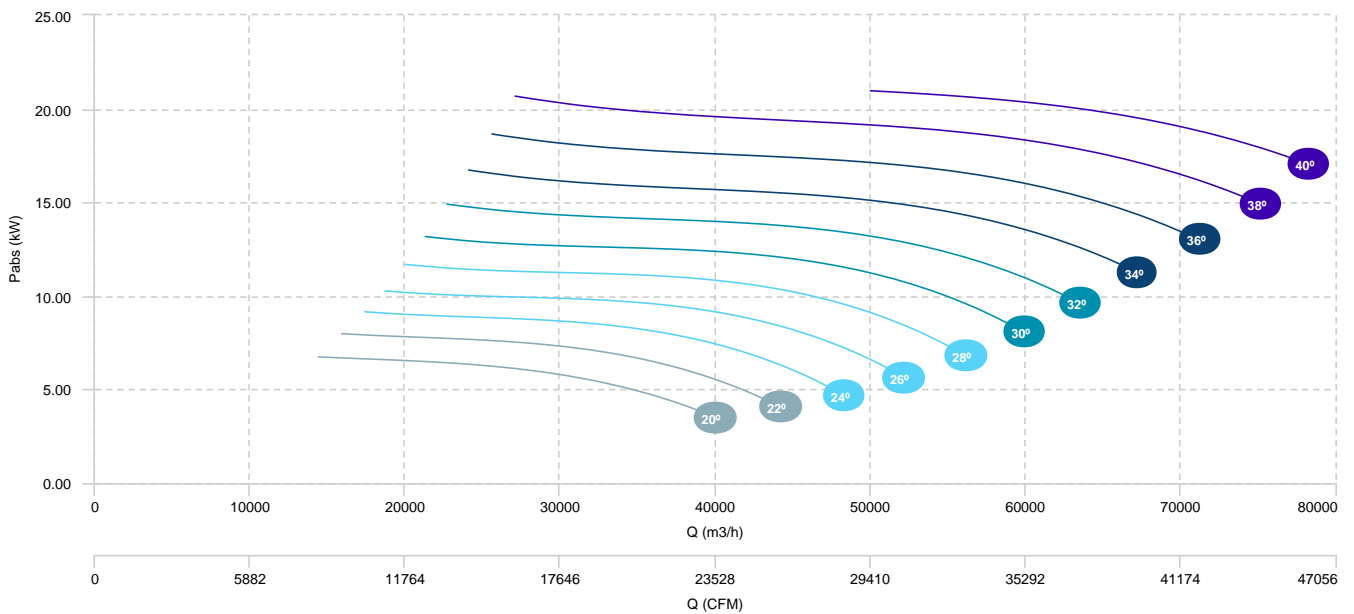

HC 100 T4 5,5kW (A6:3)	HC 100 T4 7,5kW (A6:3)	HC 100 T4 11kW (A6:3)
HC 100 T4 15kW (A6:3)		

AIR FLOW - PRESSURE

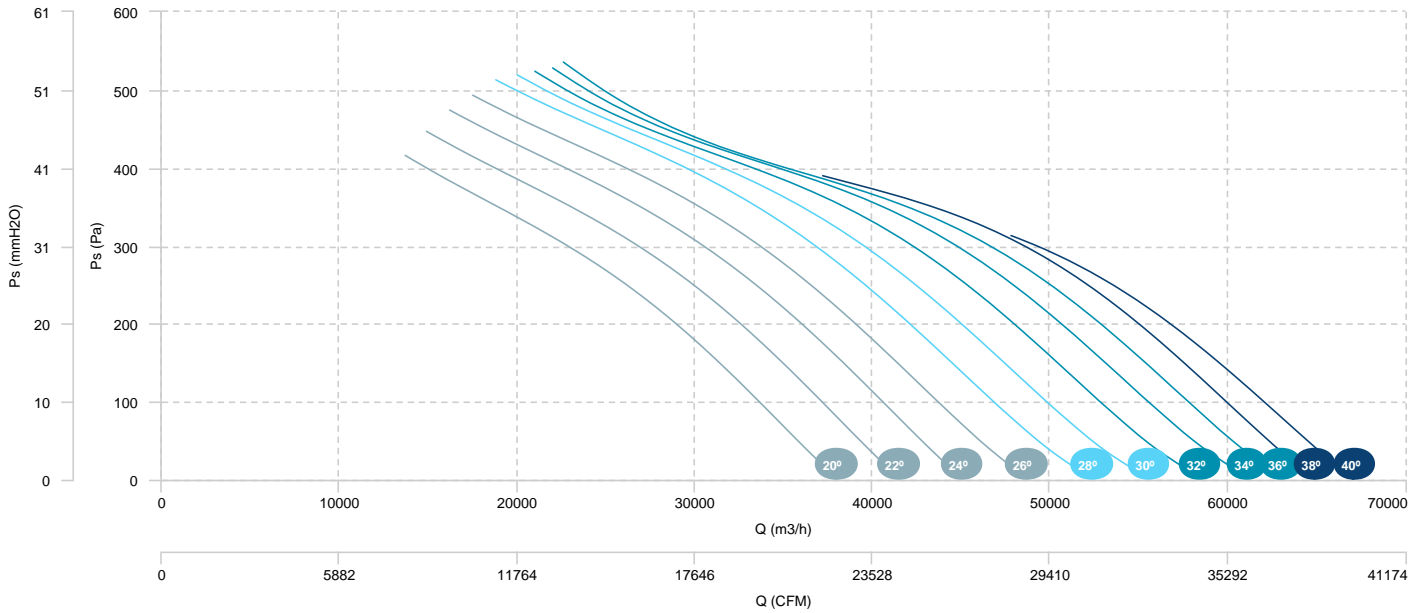

AIR FLOW - ABSORBED POWER

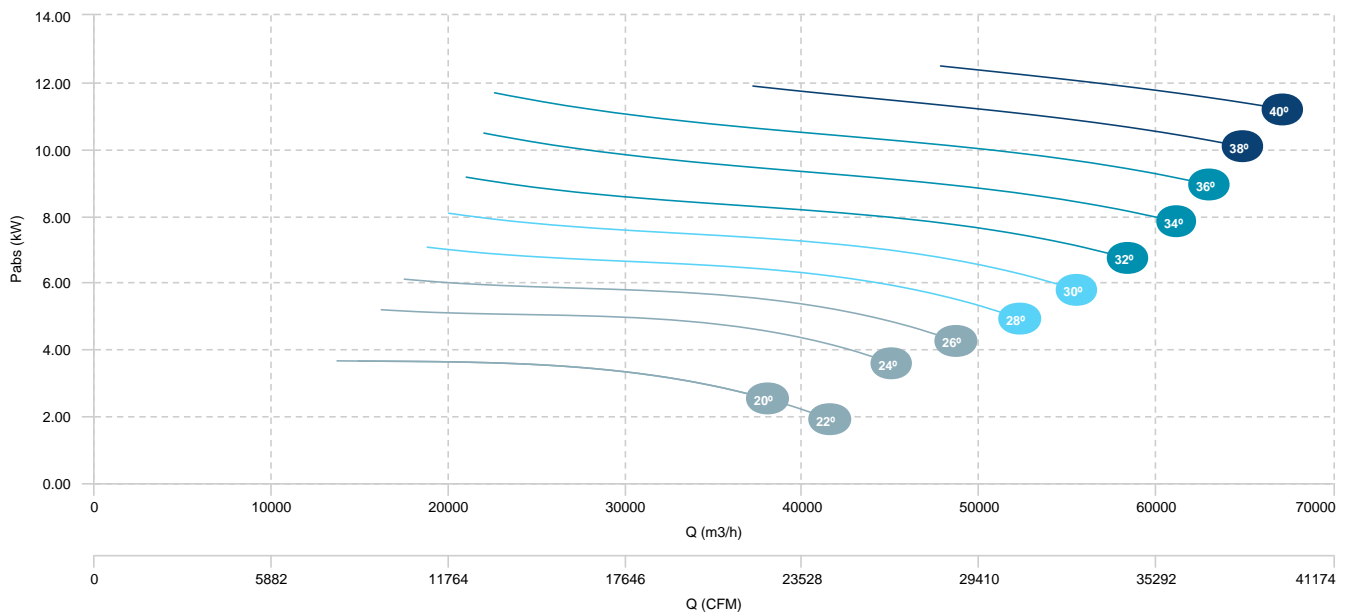

HC 100 T6 2,2kW (A6:6)	HC 100 T6 3kW (A6:6)	HC 100 T6 4kW (A6:6)
HC 100 T6 5,5kW (A6:6)	HC 100 T6 7,5kW (A6:6)	

AIR FLOW - PRESSURE

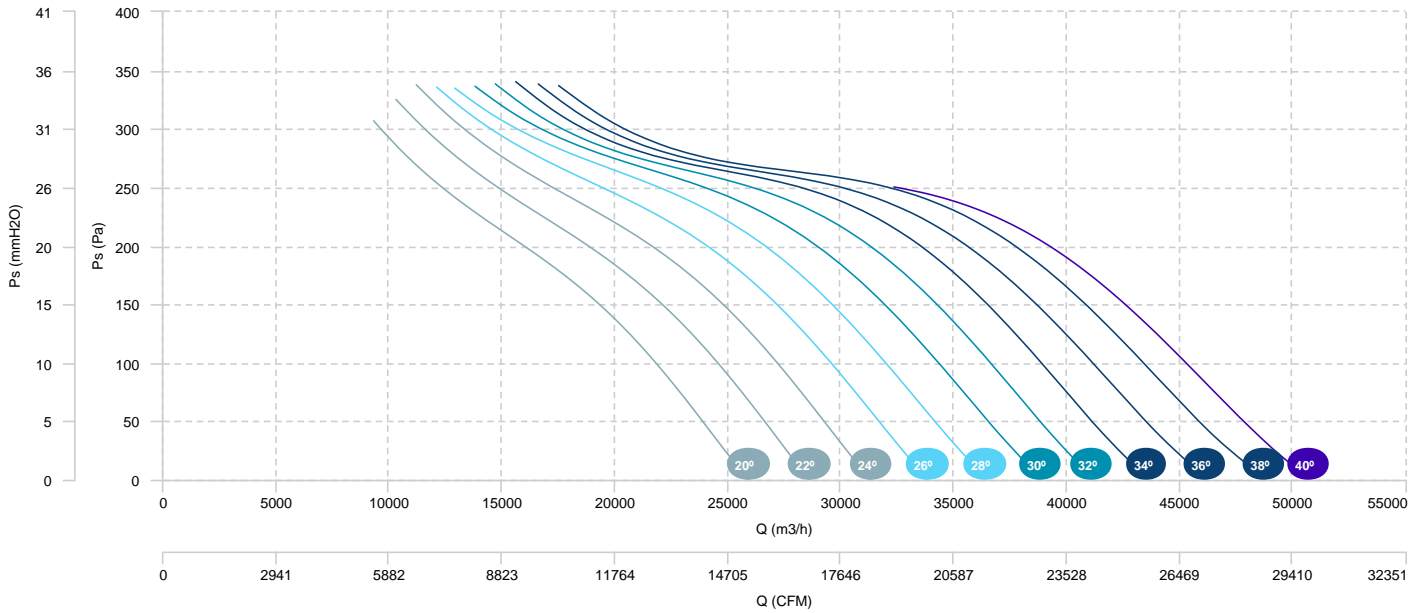

AIR FLOW - ABSORBED POWER

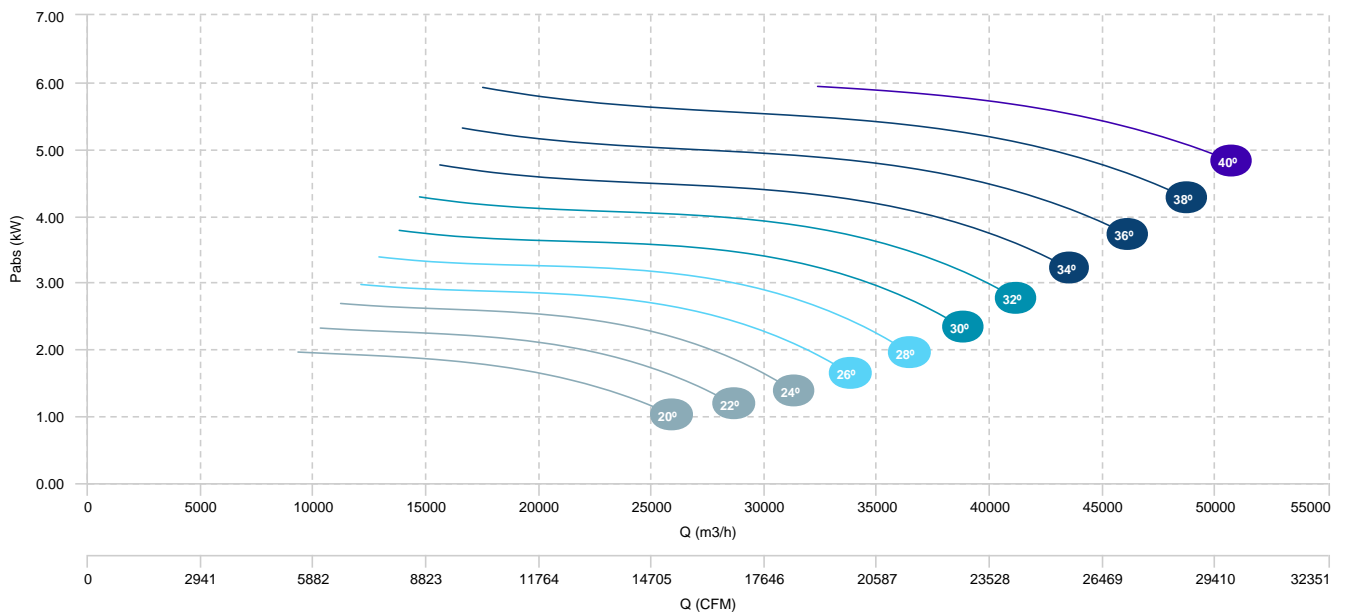

HC 100 T6 1,5kW (A6:3)	HC 100 T6 2,2kW (A6:3)	HC 100 T6 3kW (A6:3)
HC 100 T6 4kW (A6:3)		

AIR FLOW - PRESSURE

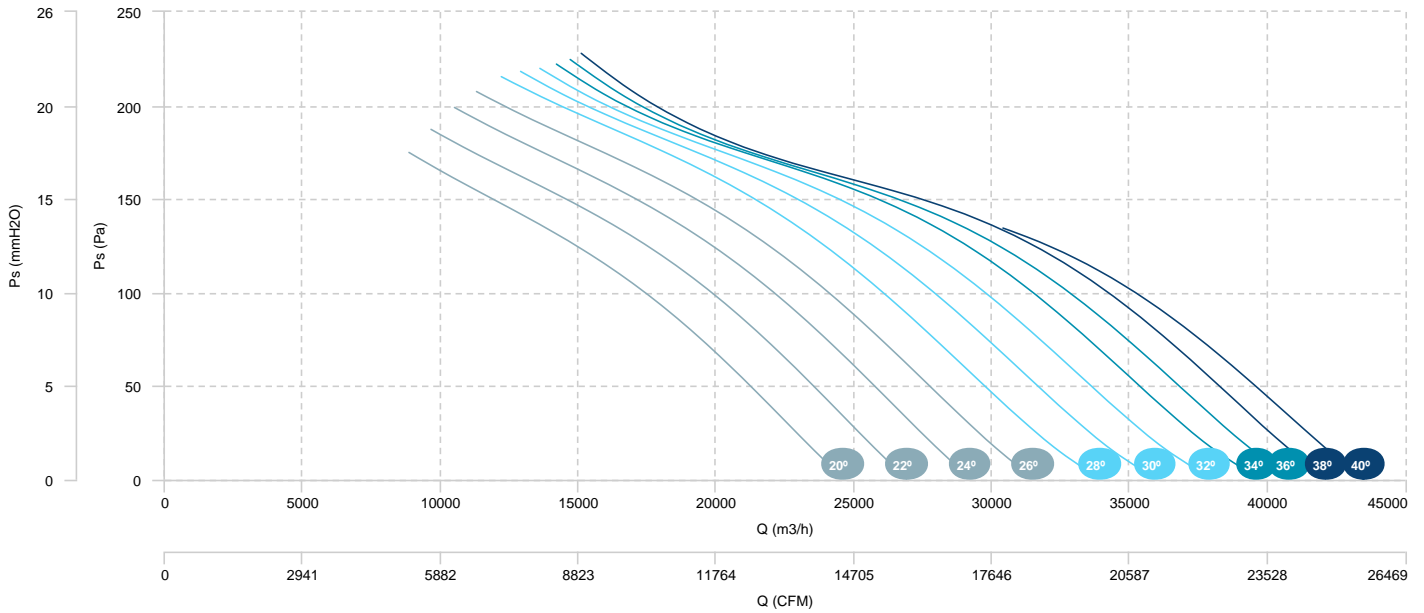

AIR FLOW - ABSORBED POWER

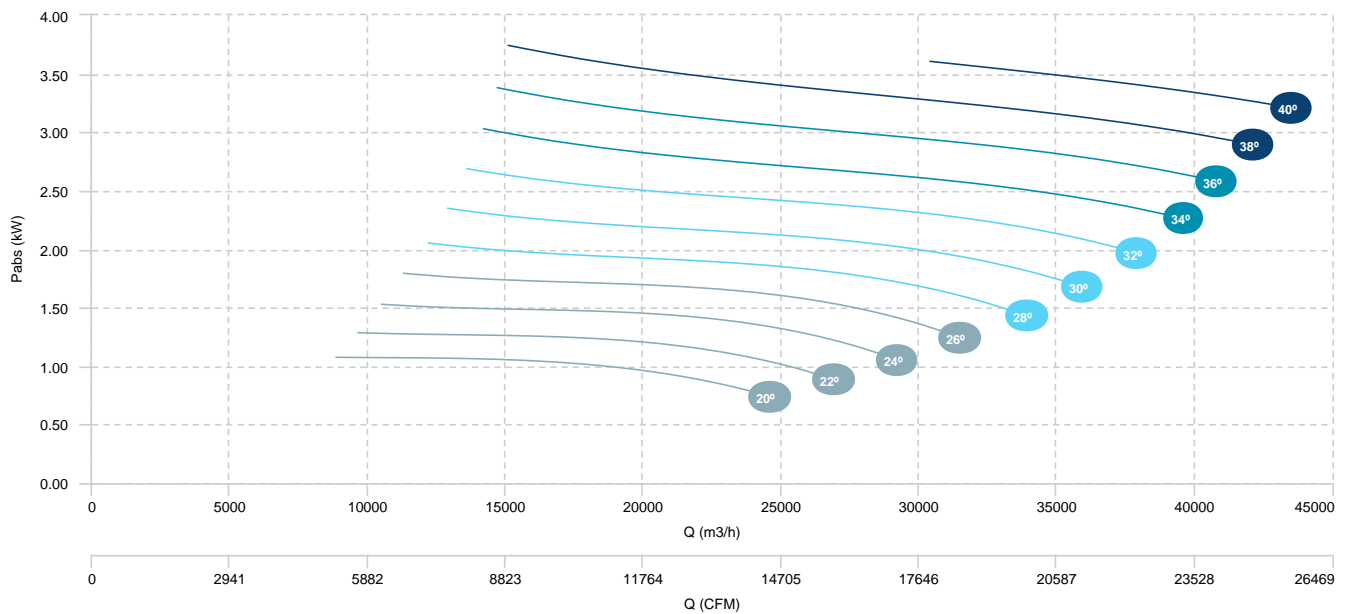

HC 100 T4/T6 7,5/2,2kW (A6:6)	HC 100 T4/T6 11/3,6kW (A6:6)	HC 100 T4/T6 15/4,4kW (A6:6)
HC 100 T4/T6 18,5/6kW (A6:6)	HC 100 T4/T6 22/7,5kW (A6:6)	

AIR FLOW - PRESSURE (4 POLES)

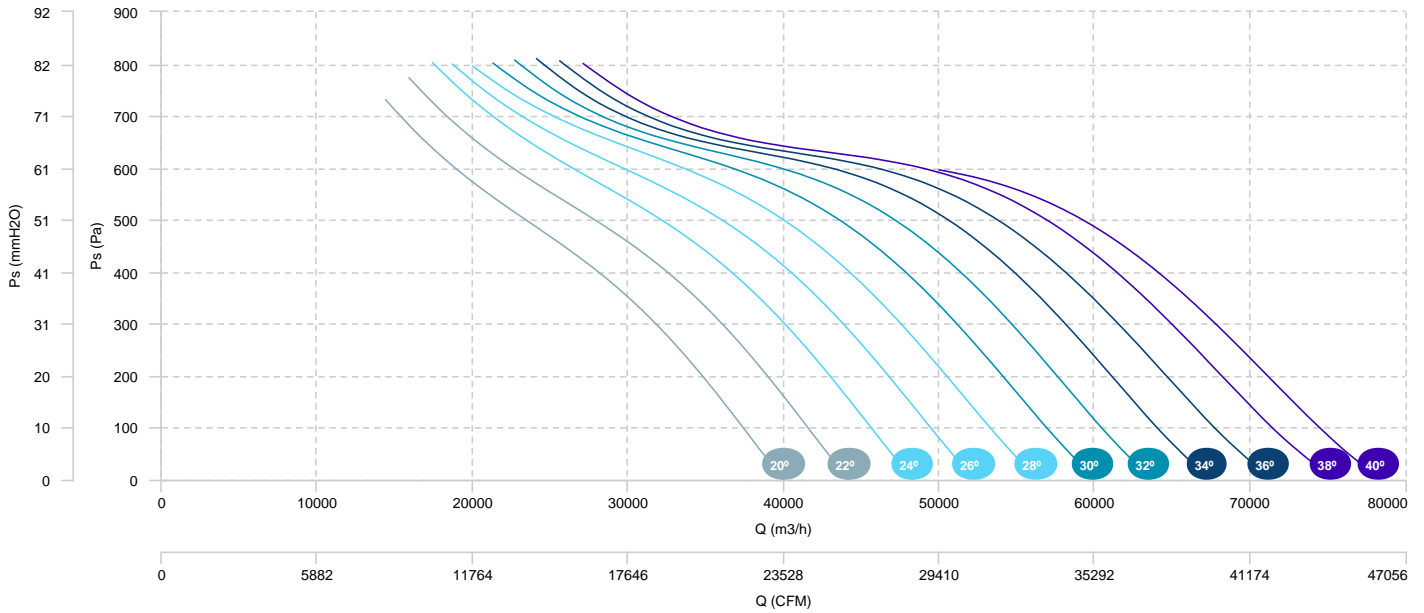

AIR FLOW - ABSORBED POWER (4 POLES)

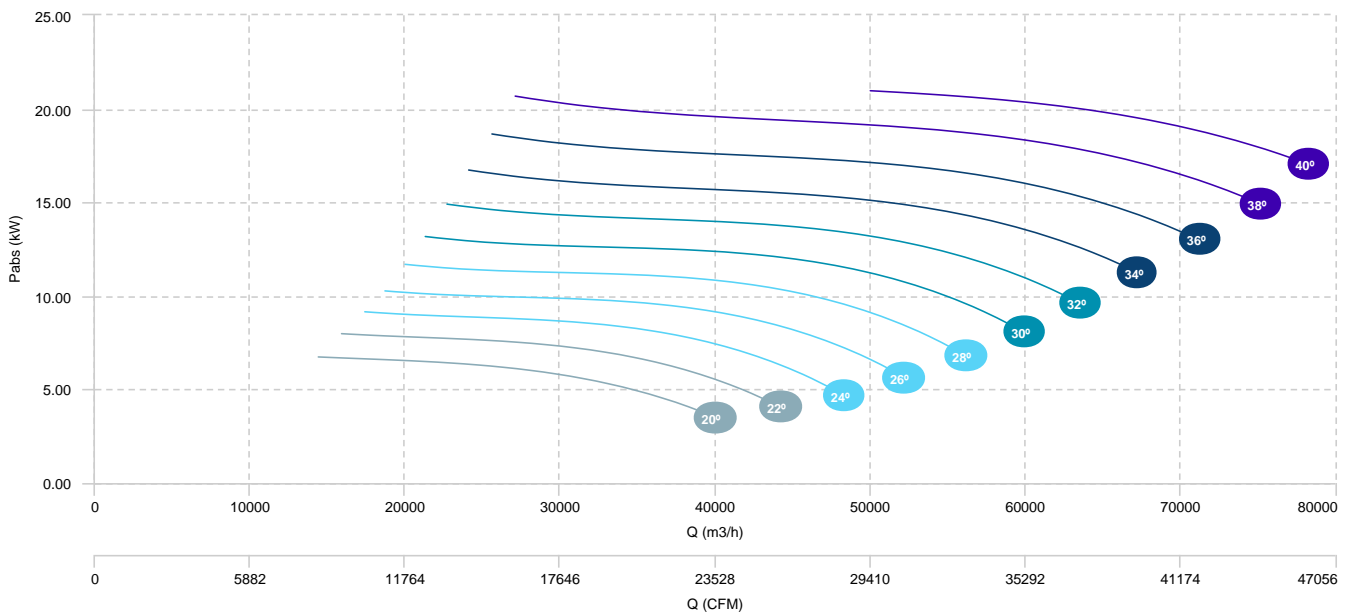

HC 100 T4/T6 7,5/2,2kW (A6:6)	HC 100 T4/T6 11/3,6kW (A6:6)	HC 100 T4/T6 15/4,4kW (A6:6)
HC 100 T4/T6 18,5/6kW (A6:6)	HC 100 T4/T6 22/7,5kW (A6:6)	

AIR FLOW - PRESSURE (6 POLES)

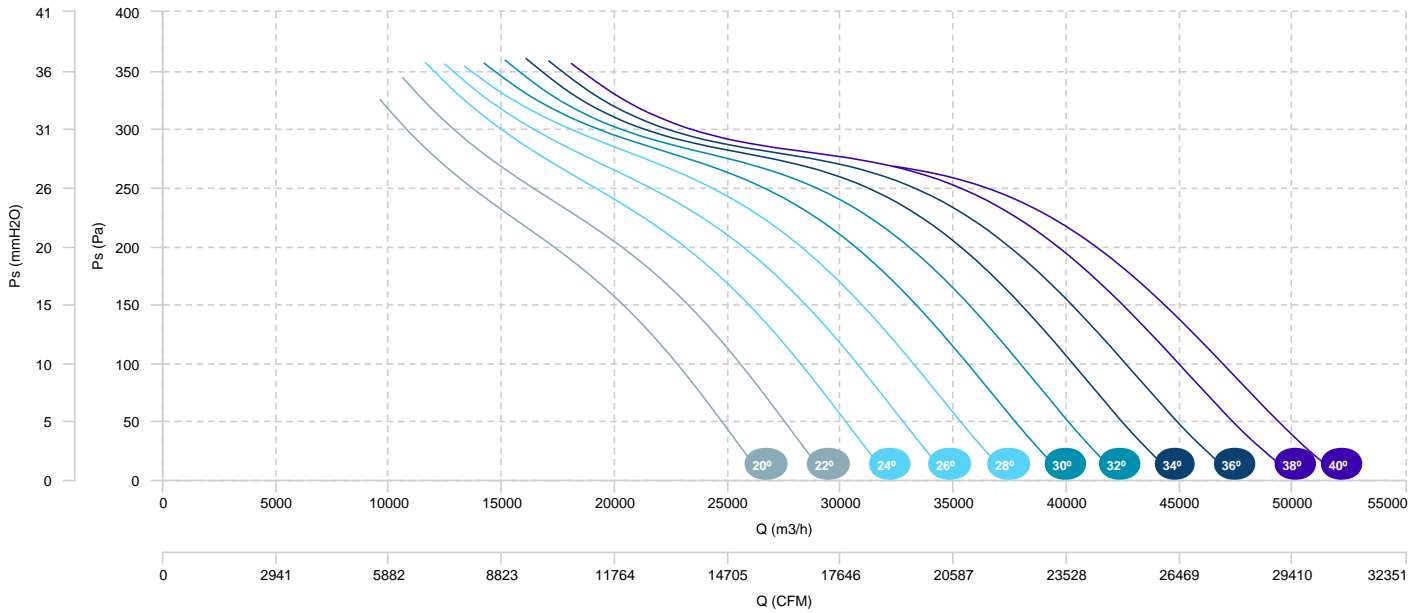

HC 100 T4/T6 5,5/1,85kW (A6:3)	HC 100 T4/T6 7,5/2,2kW (A6:3)	HC 100 T4/T6 11/3,6kW (A6:3)
HC 100 T4/T6 15/4,4kW (A6:3)		

AIR FLOW - PRESSURE (4 POLES)

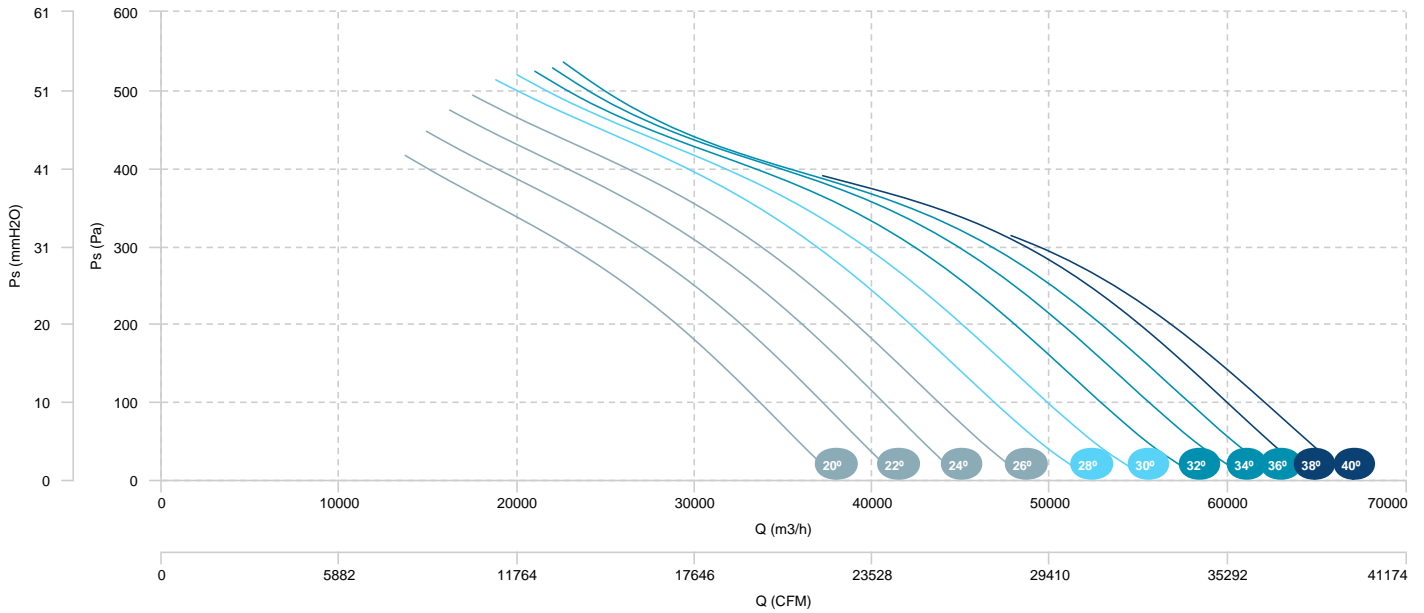

AIR FLOW - ABSORBED POWER (4 POLES)

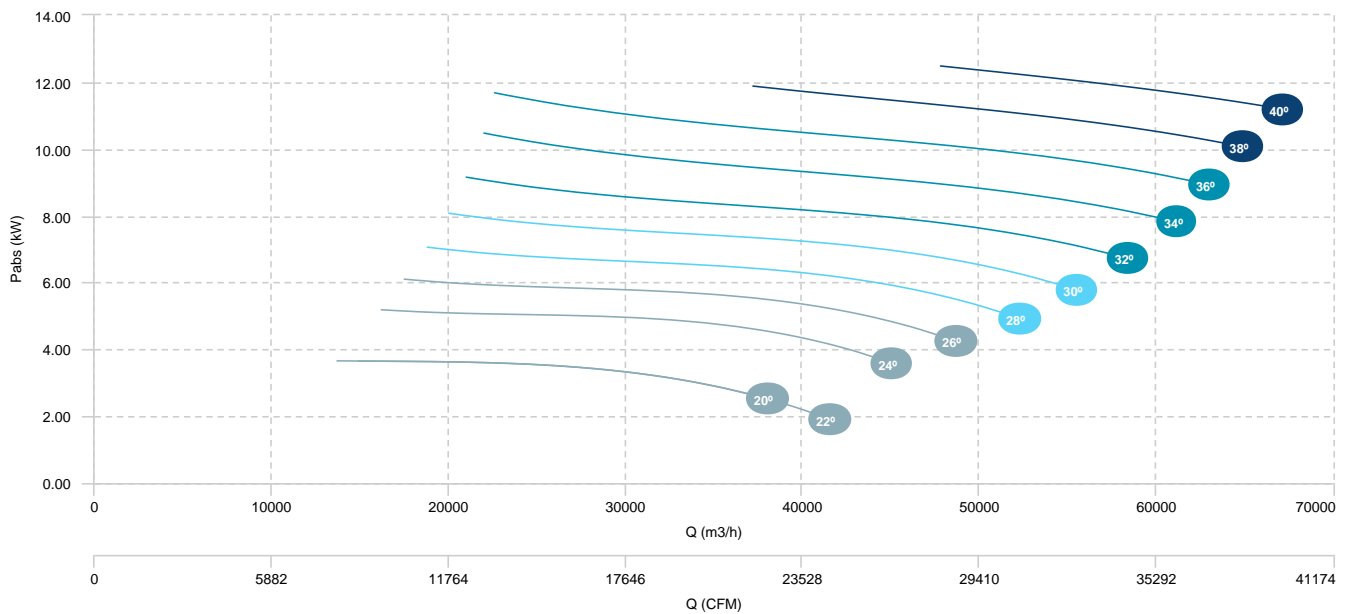

HC 100 T4/T6 5,5/1,85kW (A6:3)	HC 100 T4/T6 7,5/2,2kW (A6:3)	HC 100 T4/T6 11/3,6kW (A6:3)
HC 100 T4/T6 15/4,4kW (A6:3)		

AIR FLOW - PRESSURE (6 POLES)

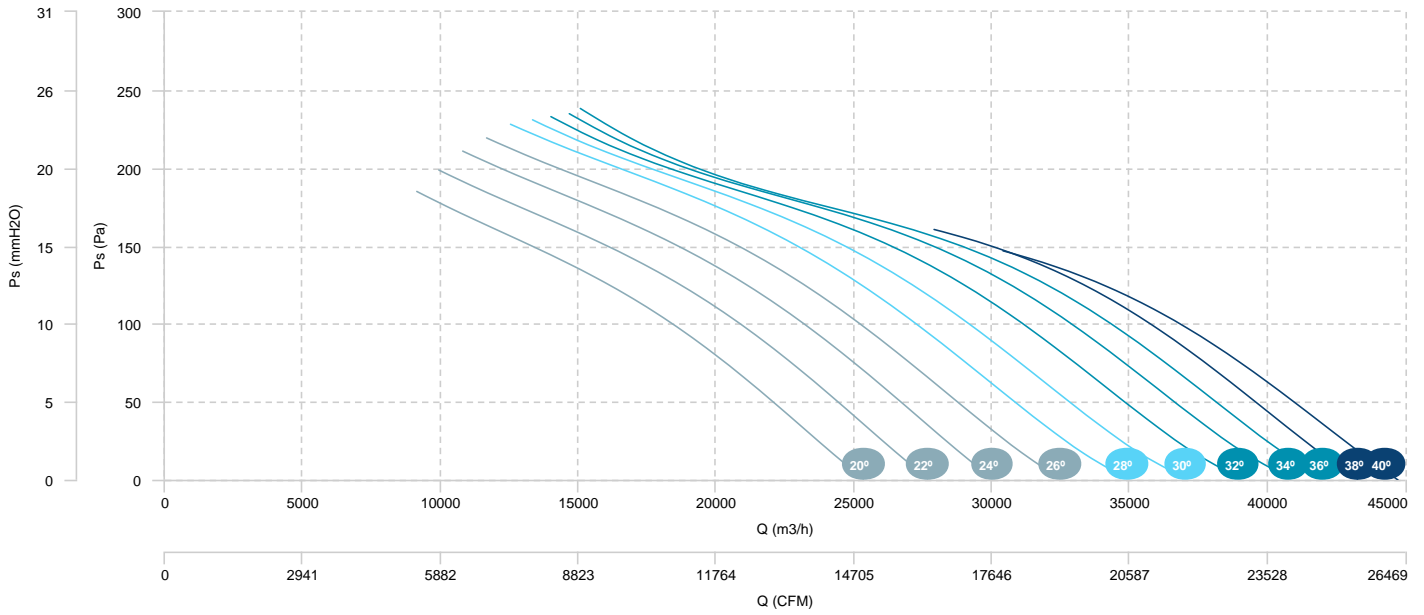

HC 100 T4/T8 5,5/1,1kW (A6:3)	HC 100 T4/T8 7,5/1,5kW (A6:3)	HC 100 T4/T8 11/3kW (A6:3)
HC 100 T4/T8 15/3,5kW (A6:3)		

AIR FLOW - PRESSURE (4 POLES)

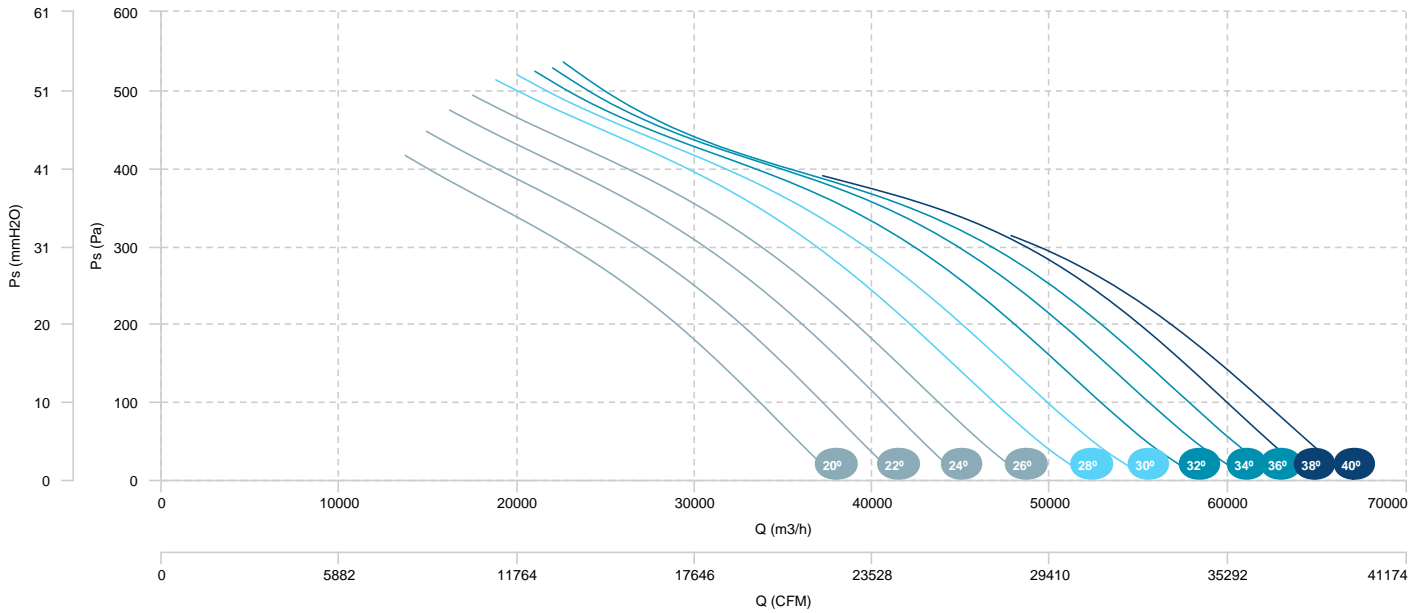

AIR FLOW - ABSORBED POWER (4 POLES)

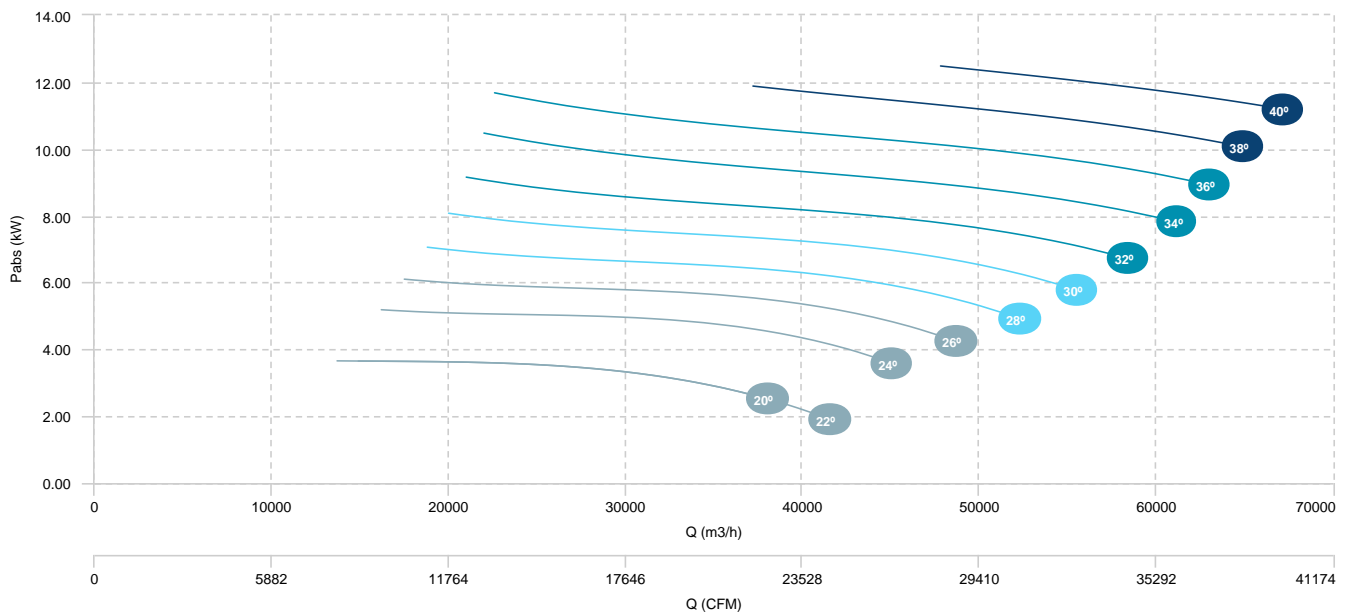

HC 100 T4/T8 5,5/1,1kW (A6:3)	HC 100 T4/T8 7,5/1,5kW (A6:3)	HC 100 T4/T8 11/3kW (A6:3)
HC 100 T4/T8 15/3,5kW (A6:3)		

AIR FLOW - PRESSURE (8 POLES)

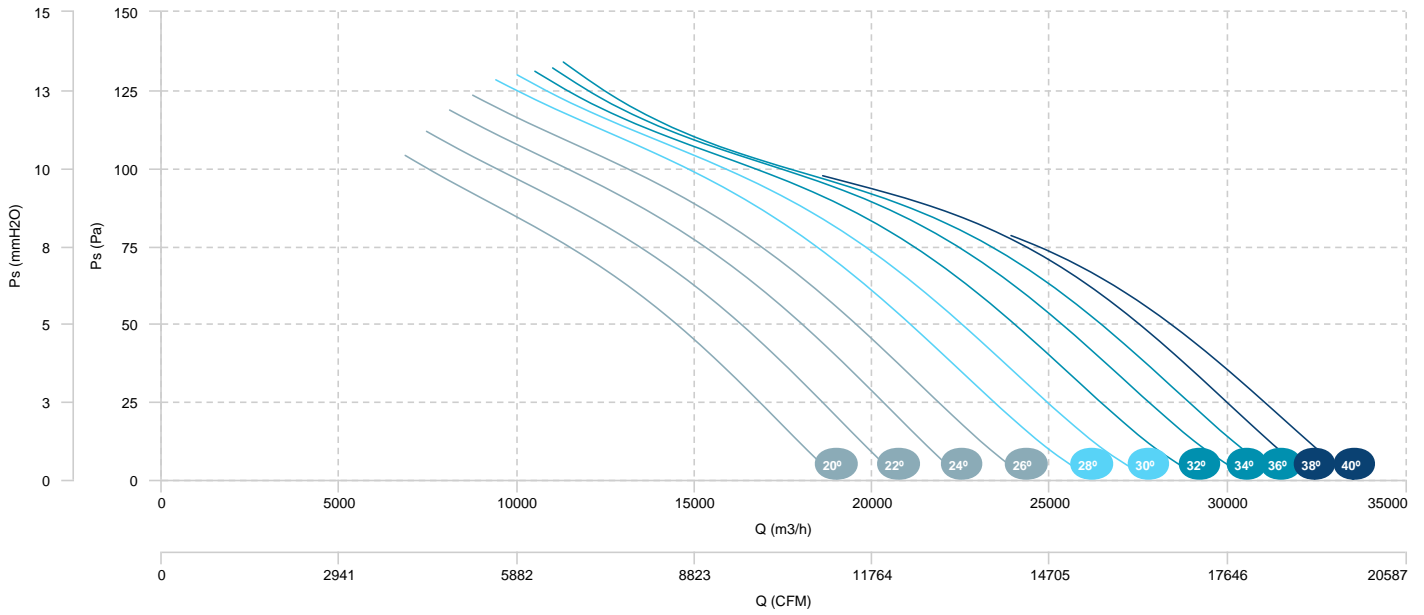

HC 100 T4/T8 7,5/1,5kW (A6:6)	HC 100 T4/T8 11/3kW (A6:6)	HC 100 T4/T8 15/3,5kW (A6:6)
HC 100 T4/T8 17/4,3kW (A6:6)	HC 100 T4/T8 20/5kW (A6:6)	

AIR FLOW - PRESSURE (4 POLES)

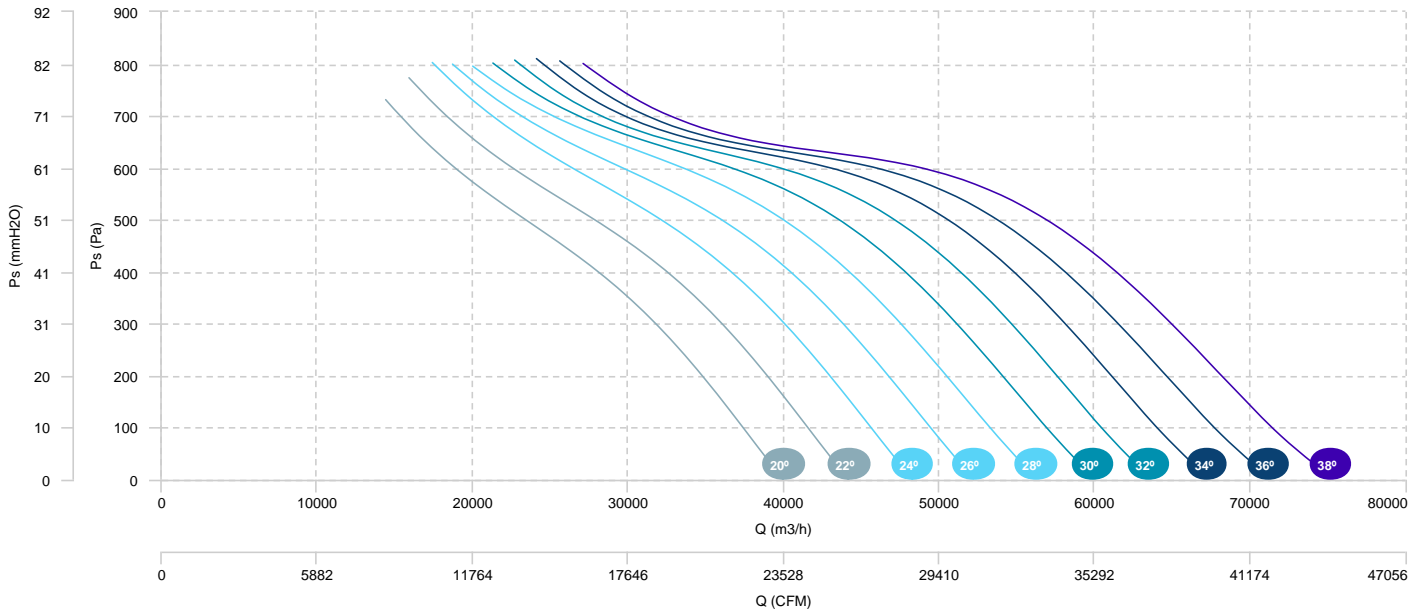

AIR FLOW - ABSORBED POWER (4 POLES)

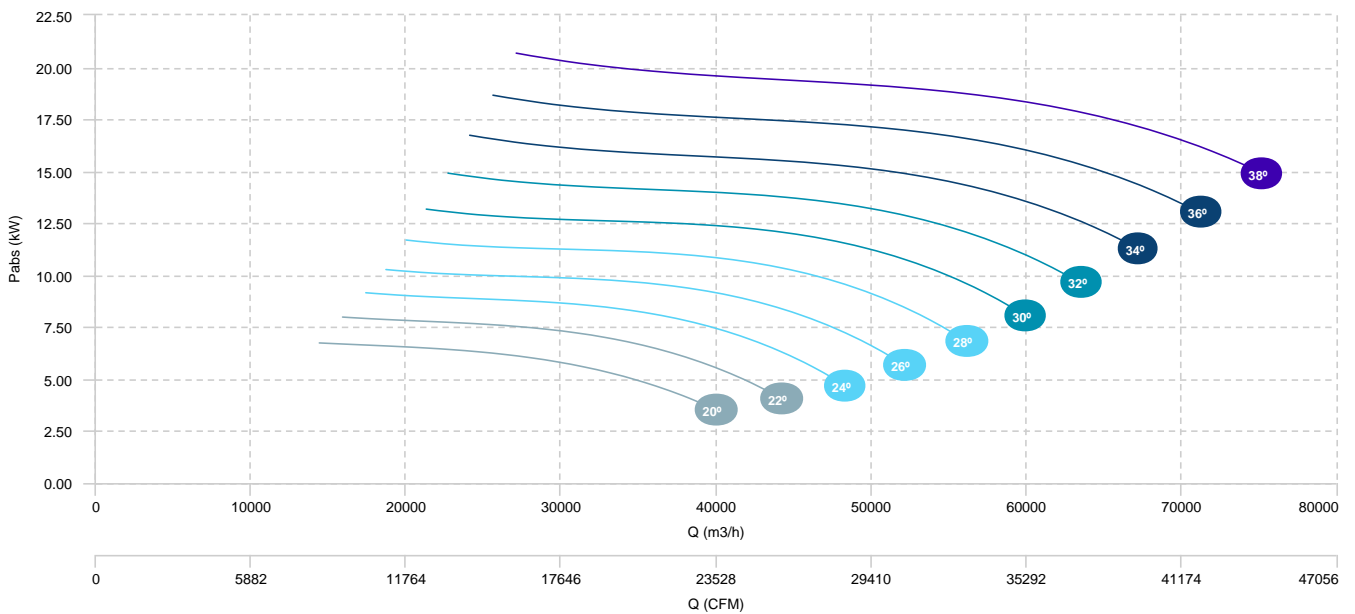

HC 100 T4/T8 7,5/1,5kW (A6:6)	HC 100 T4/T8 11/3kW (A6:6)	HC 100 T4/T8 15/3,5kW (A6:6)
HC 100 T4/T8 17/4,3kW (A6:6)	HC 100 T4/T8 20/5kW (A6:6)	

AIR FLOW - PRESSURE (8 POLES)

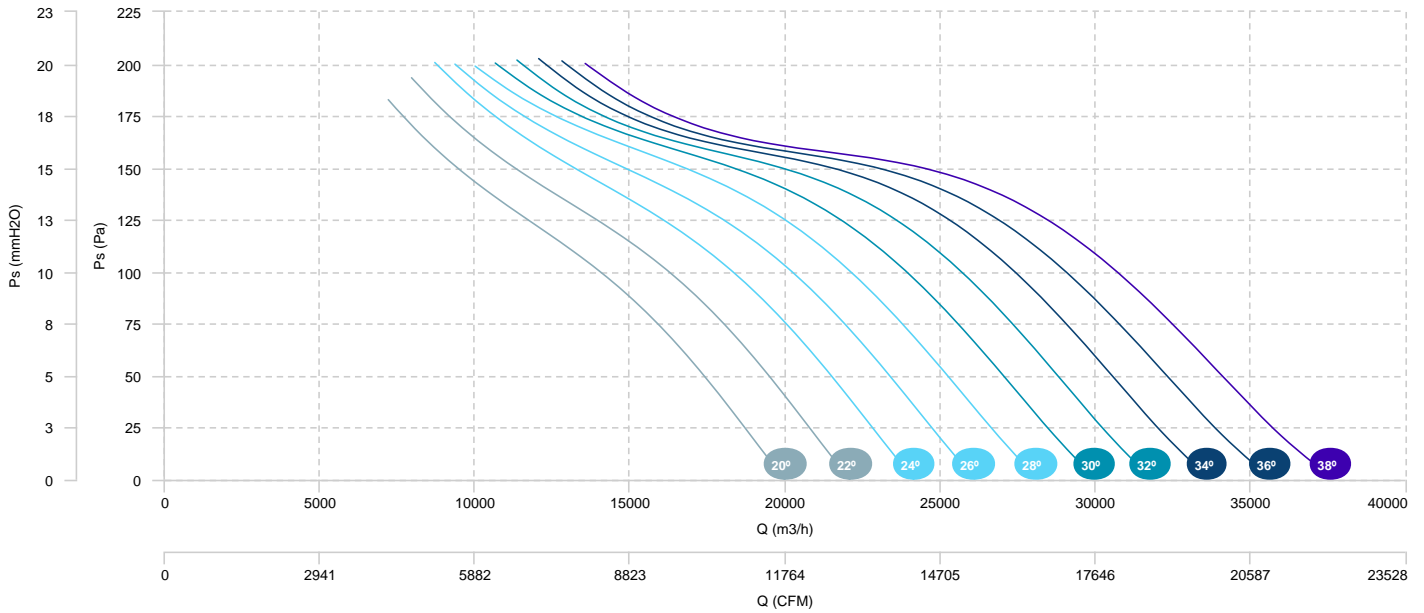

HC 112 T4 11kW (A6:6)	HC 112 T4 15kW (A6:6)	HC 112 T4 18,5kW (A6:6)
HC 112 T4 22kW (A6:6)	HC 112 T4 30kW (A6:6)	

AIR FLOW - PRESSURE

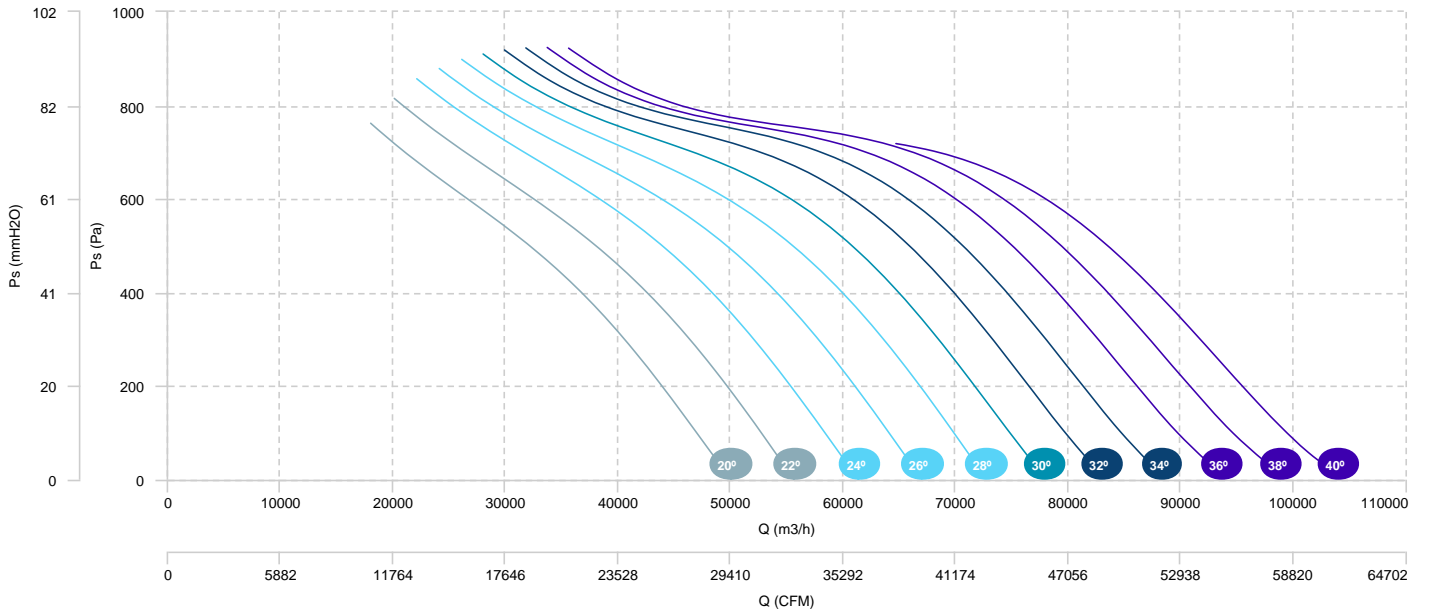

AIR FLOW - ABSORBED POWER

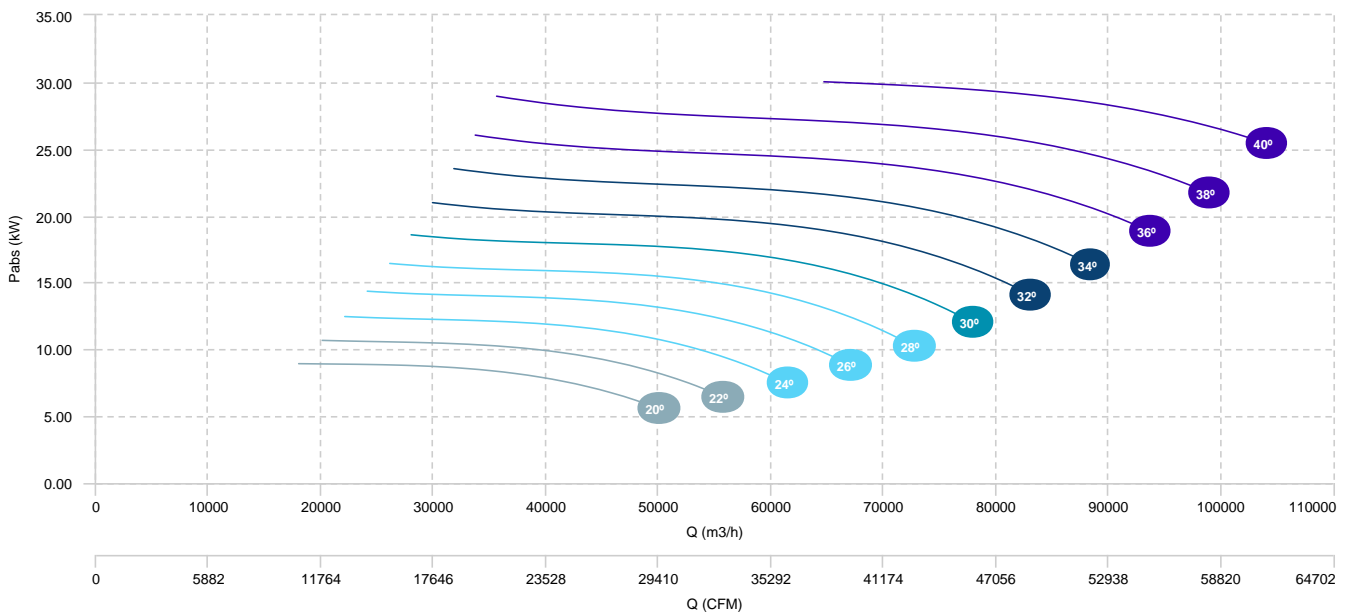

HC 112 T4 5,5kW (A6:3)	HC 112 T4 7,5kW (A6:3)	HC 112 T4 11kW (A6:3)
HC 112 T4 15kW (A6:3)	HC 112 T4 18,5kW (A6:3)	HC 112 T4 22kW (A6:3)

AIR FLOW - PRESSURE

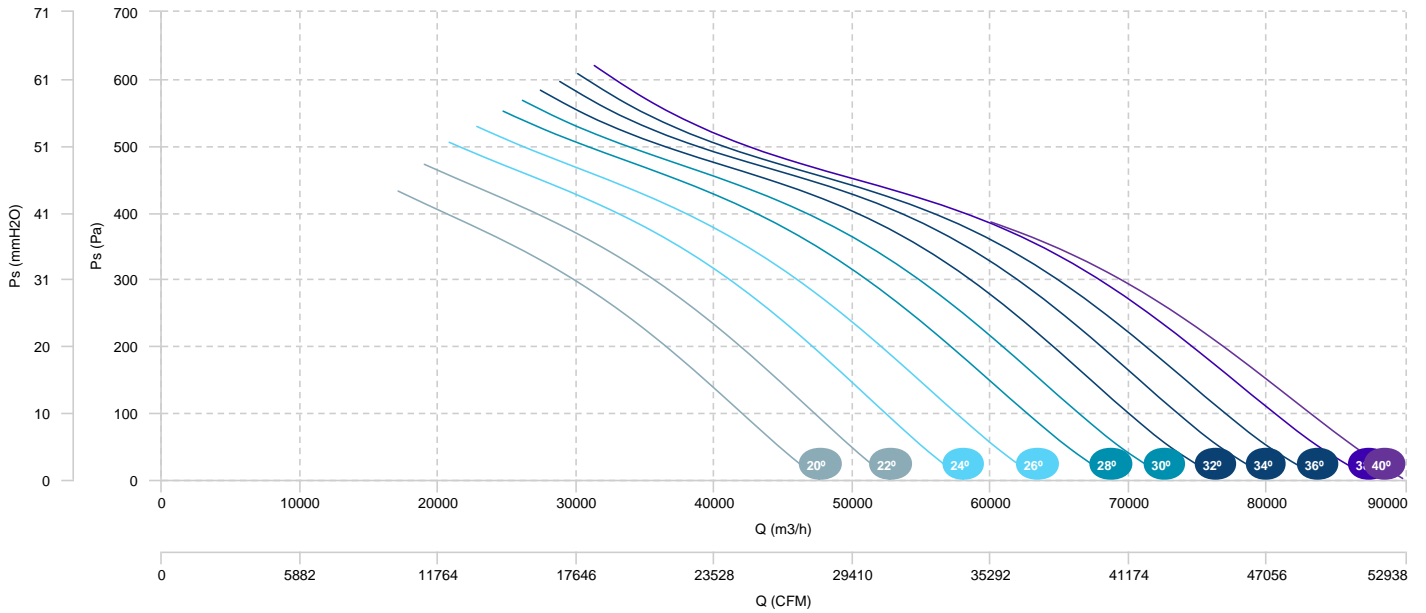

AIR FLOW - ABSORBED POWER

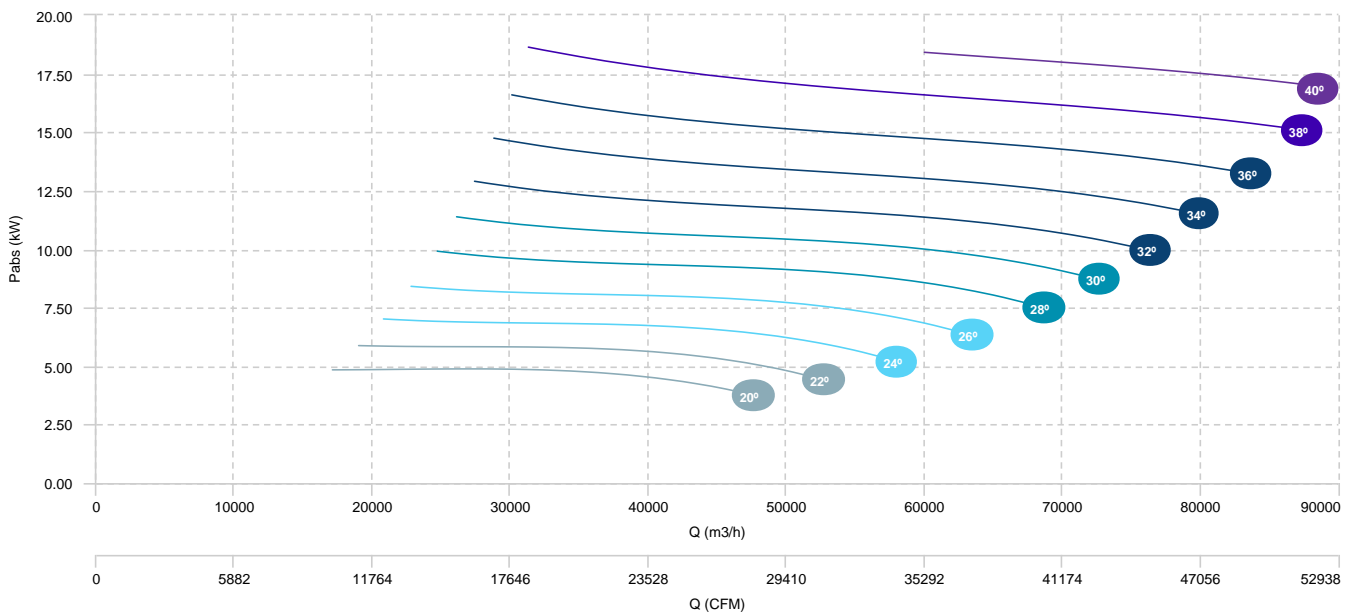

HC 112 T6 2,2kW (A6:6)	HC 112 T6 3kW (A6:6)	HC 112 T6 4kW (A6:6)
HC 112 T6 5,5kW (A6:6)	HC 112 T6 7,5kW (A6:6)	HC 112 T6 11kW (A6:6)

AIR FLOW - PRESSURE

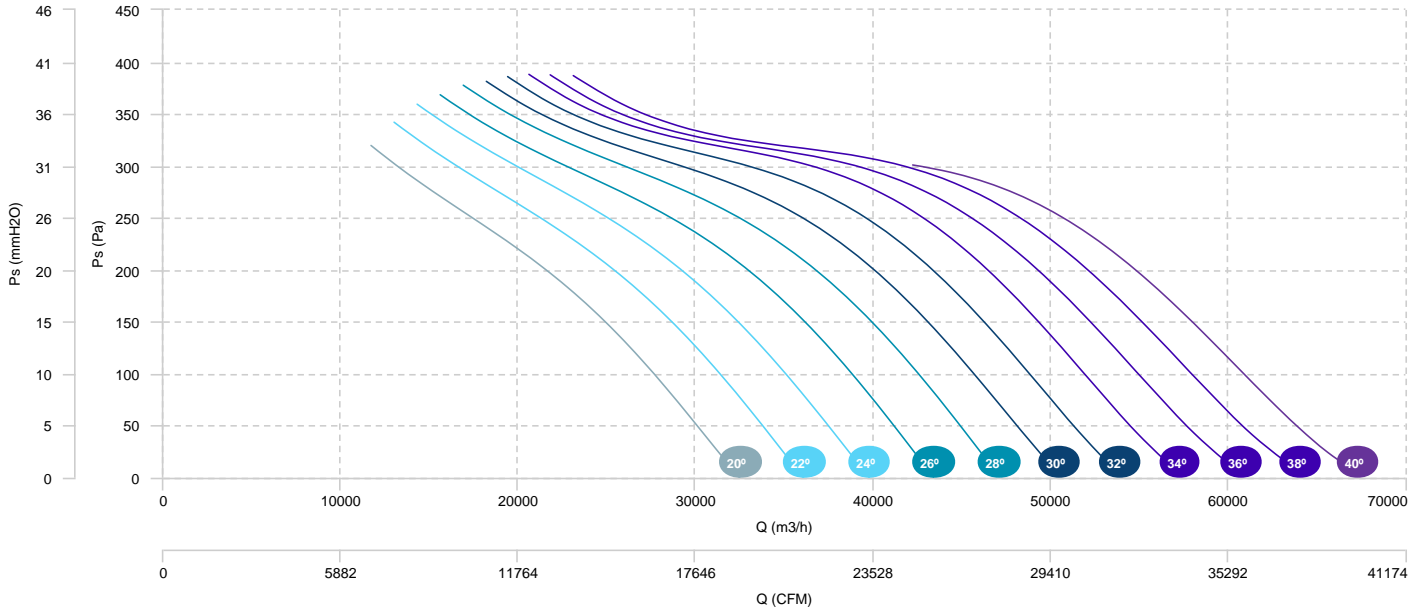

AIR FLOW - ABSORBED POWER

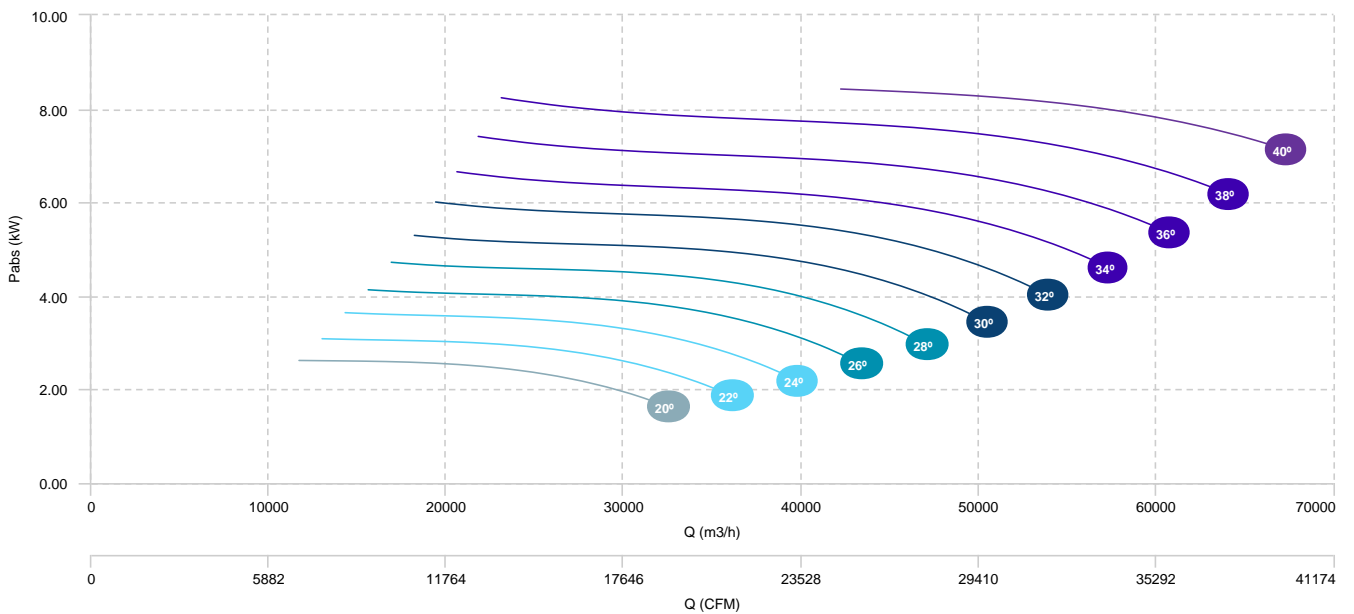

HC 112 T6 2,2kW (A6:3)	HC 112 T6 3kW (A6:3)	HC 112 T6 4kW (A6:3)
HC 112 T6 5,5kW (A6:3)		

AIR FLOW - PRESSURE

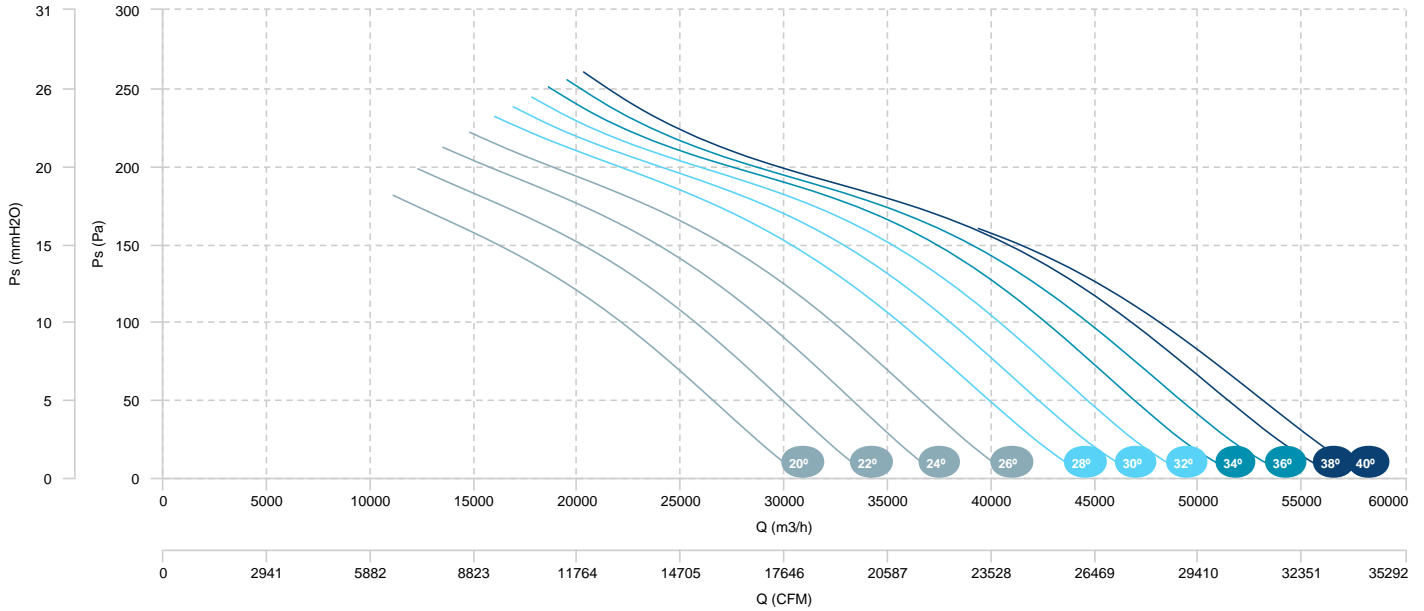

AIR FLOW - ABSORBED POWER

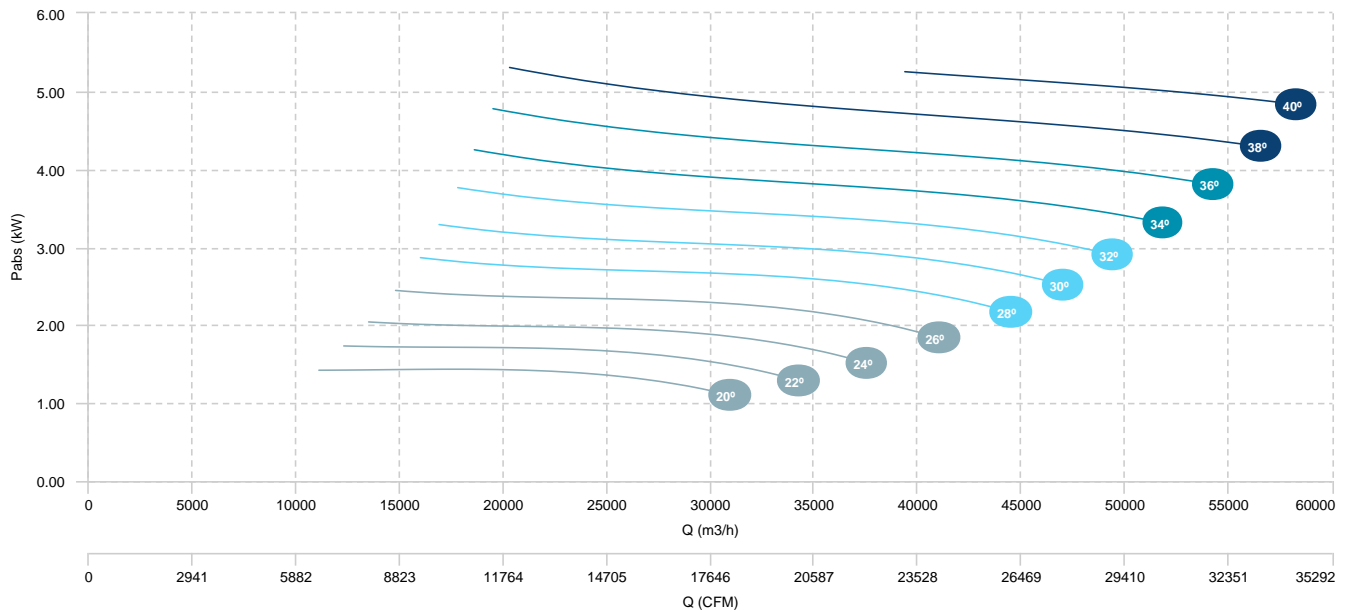

HC 112 T4/T6 11/3,6kW (A6:6)	HC 112 T4/T6 15/4,4kW (A6:6)	HC 112 T4/T6 18,5/6kW (A6:6)
HC 112 T4/T6 22/7,5kW (A6:6)		

AIR FLOW - PRESSURE (4 POLES)

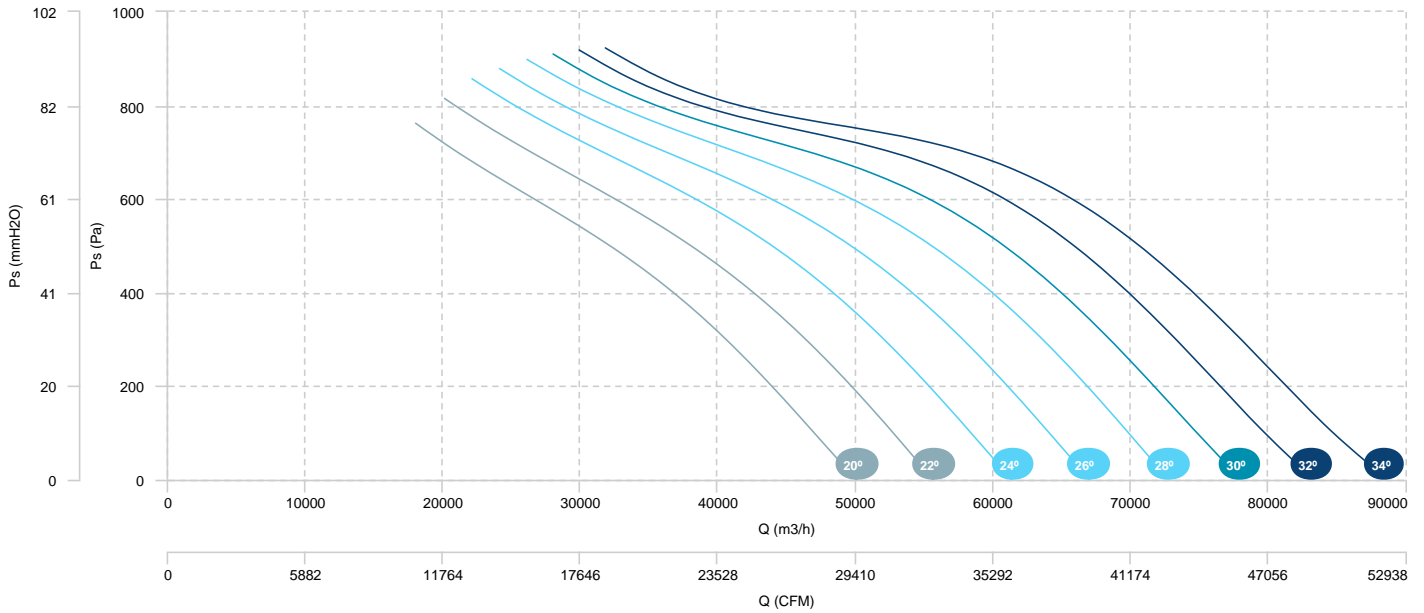

AIR FLOW - ABSORBED POWER (4 POLES)

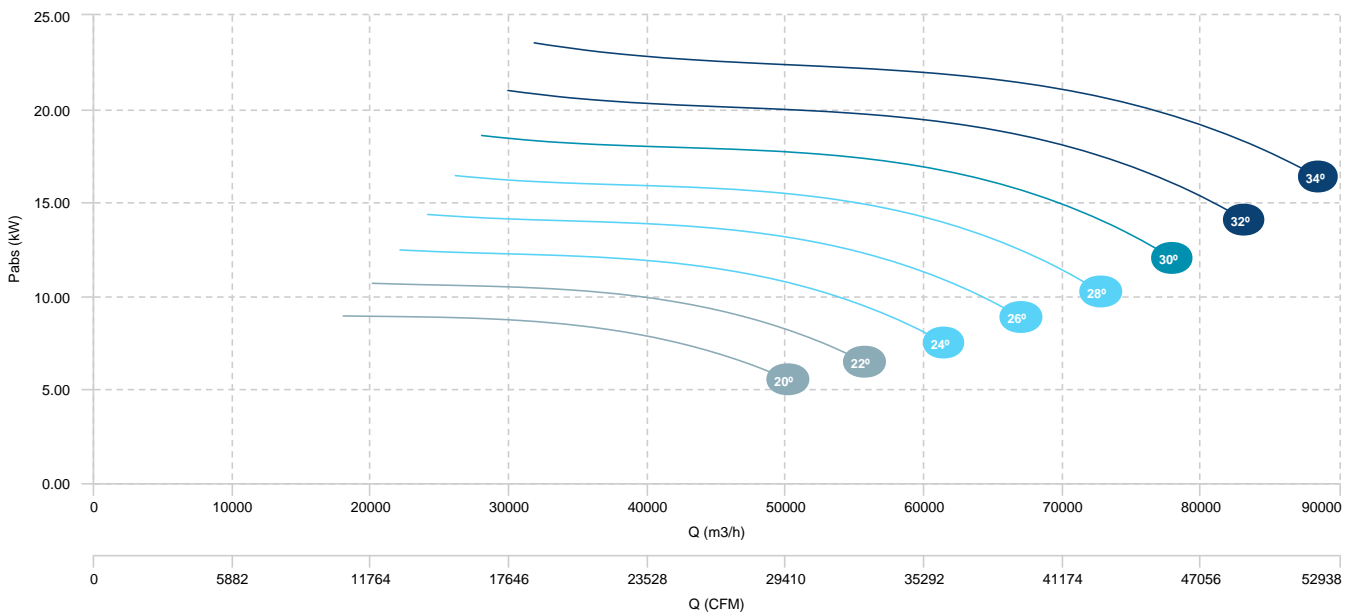

HC 112 T4/T6 11/3,6kW (A6:6)	HC 112 T4/T6 15/4,4kW (A6:6)	HC 112 T4/T6 18,5/6kW (A6:6)
HC 112 T4/T6 22/7,5kW (A6:6)		

AIR FLOW - PRESSURE (6 POLES)

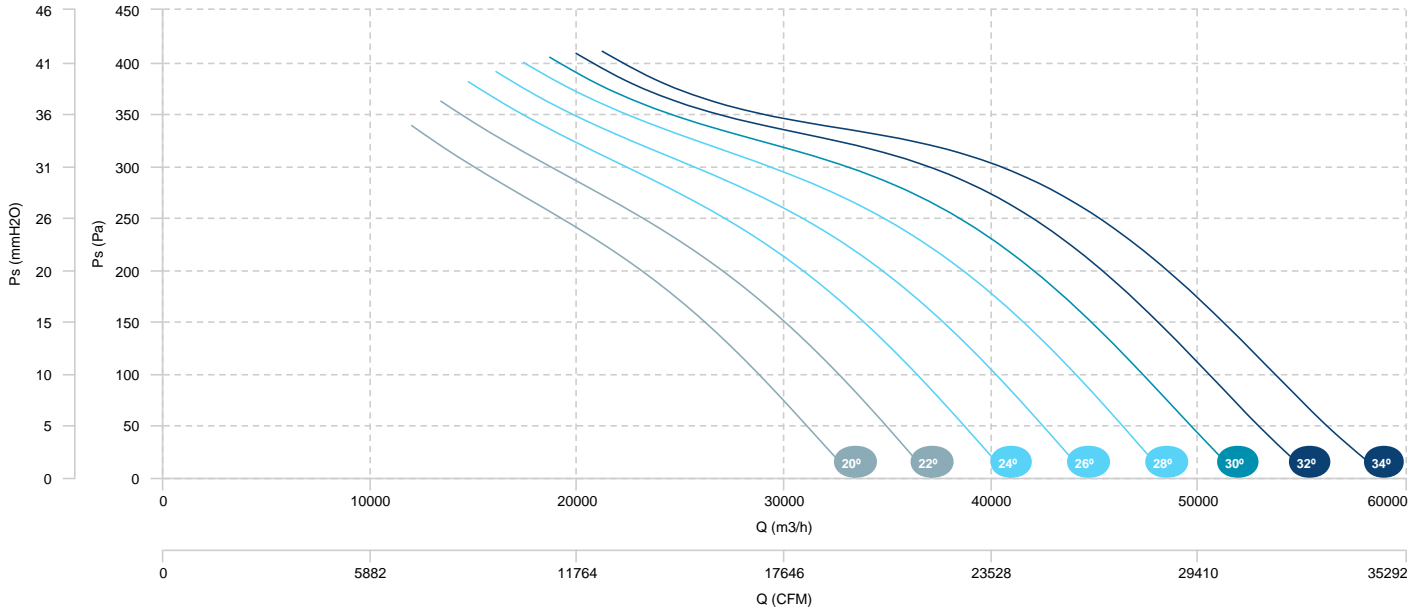

HC 112 T4/T6 5,5/1,85kW (A6:3)	HC 112 T4/T6 7,5/2,2kW (A6:3)	HC 112 T4/T6 11/3,6kW (A6:3)
HC 112 T4/T6 15/4,4kW (A6:3)	HC 112 T4/T6 18,5/6kW (A6:3)	HC 112 T4/T6 22/7,5kW (A6:3)

AIR FLOW - PRESSURE (4 POLES)

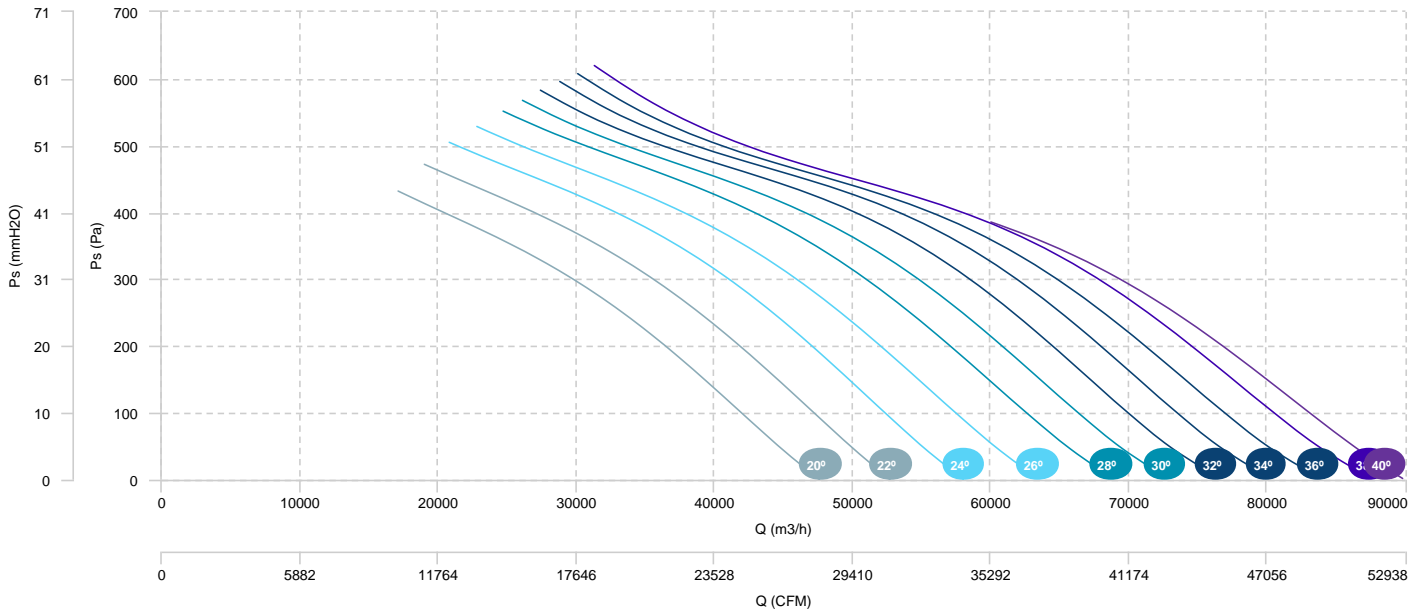

AIR FLOW - ABSORBED POWER (4 POLES)



HC 112 T4/T6 5,5/1,85kW (A6:3)	HC 112 T4/T6 7,5/2,2kW (A6:3)	HC 112 T4/T6 11/3,6kW (A6:3)
HC 112 T4/T6 15/4,4kW (A6:3)	HC 112 T4/T6 18,5/6kW (A6:3)	HC 112 T4/T6 22/7,5kW (A6:3)

AIR FLOW - PRESSURE (6 POLES)

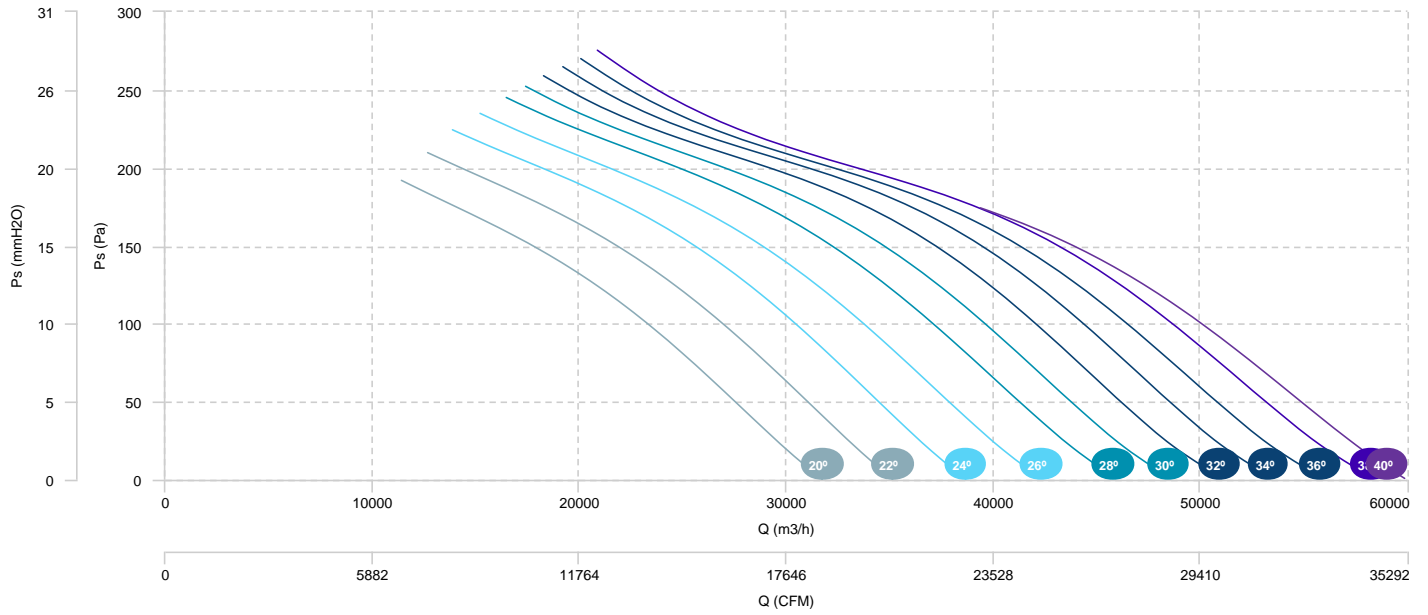

HC 112 T4/T8 11/3kW (A6:6)	HC 112 T4/T8 15/3,5kW (A6:6)	HC 112 T4/T8 17/4,3kW (A6:6)
HC 112 T4/T8 20/5kW (A6:6)	HC 112 T4/T8 28/6,5kW (A6:6)	HC 112 T4/T8 35/8kW (A6:6)

AIR FLOW - PRESSURE (4 POLES)

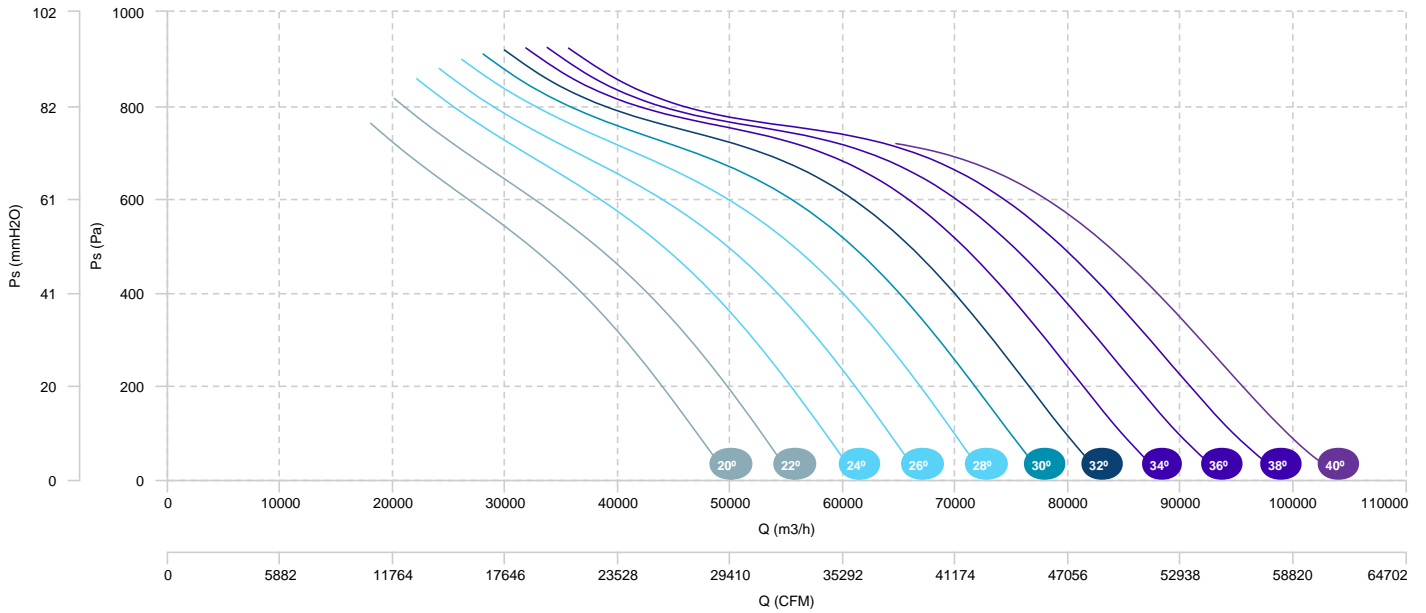

AIR FLOW - ABSORBED POWER (4 POLES)

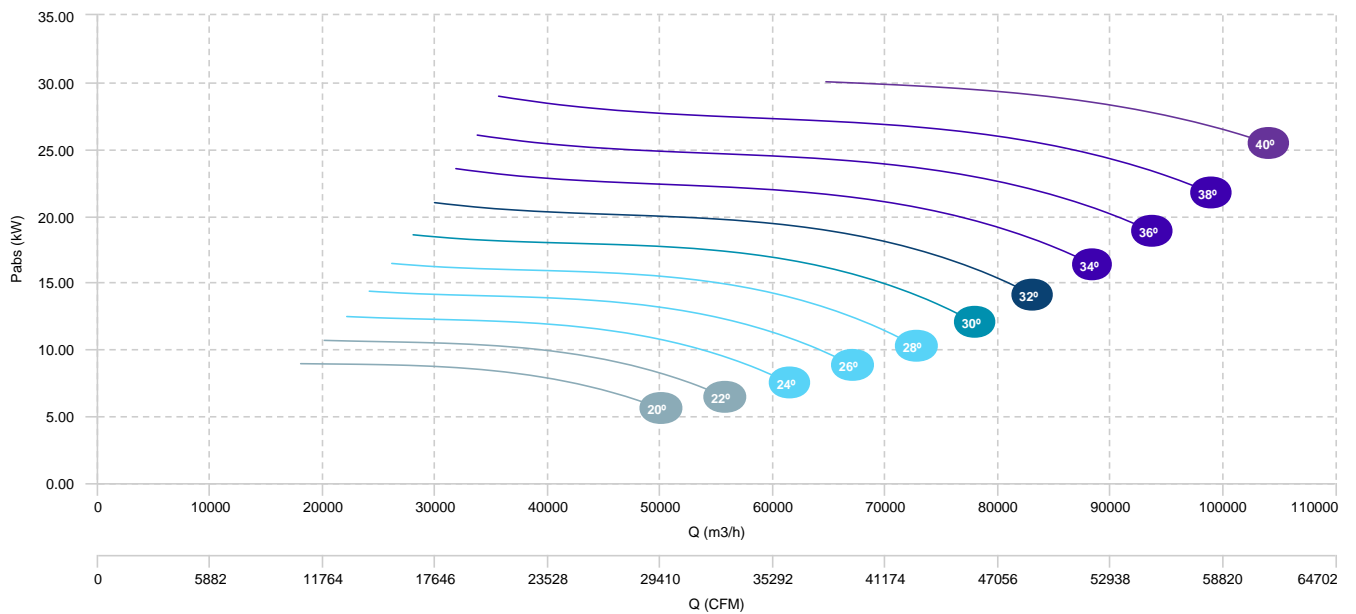

HC 112 T4/T8 11/3kW (A6:6)	HC 112 T4/T8 15/3,5kW (A6:6)	HC 112 T4/T8 17/4,3kW (A6:6)
HC 112 T4/T8 20/5kW (A6:6)	HC 112 T4/T8 28/6,5kW (A6:6)	HC 112 T4/T8 35/8kW (A6:6)

AIR FLOW - PRESSURE (8 POLES)

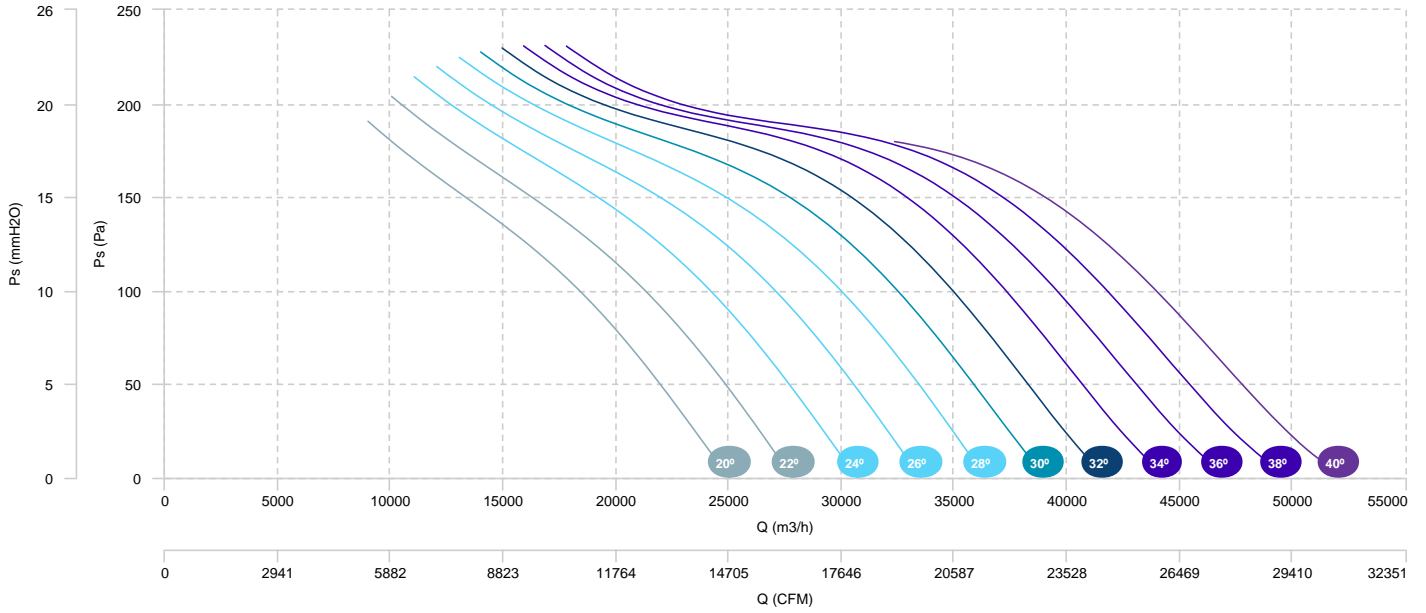

HC 112 T4/T8 5,5/1,1kW (A6:3)	HC 112 T4/T8 7,5/1,5kW (A6:3)	HC 112 T4/T8 11/3kW (A6:3)
HC 112 T4/T8 15/3,5kW (A6:3)	HC 112 T4/T8 17/4,3kW (A6:3)	HC 112 T4/T8 20/5kW (A6:3)

AIR FLOW - PRESSURE (4 POLES)

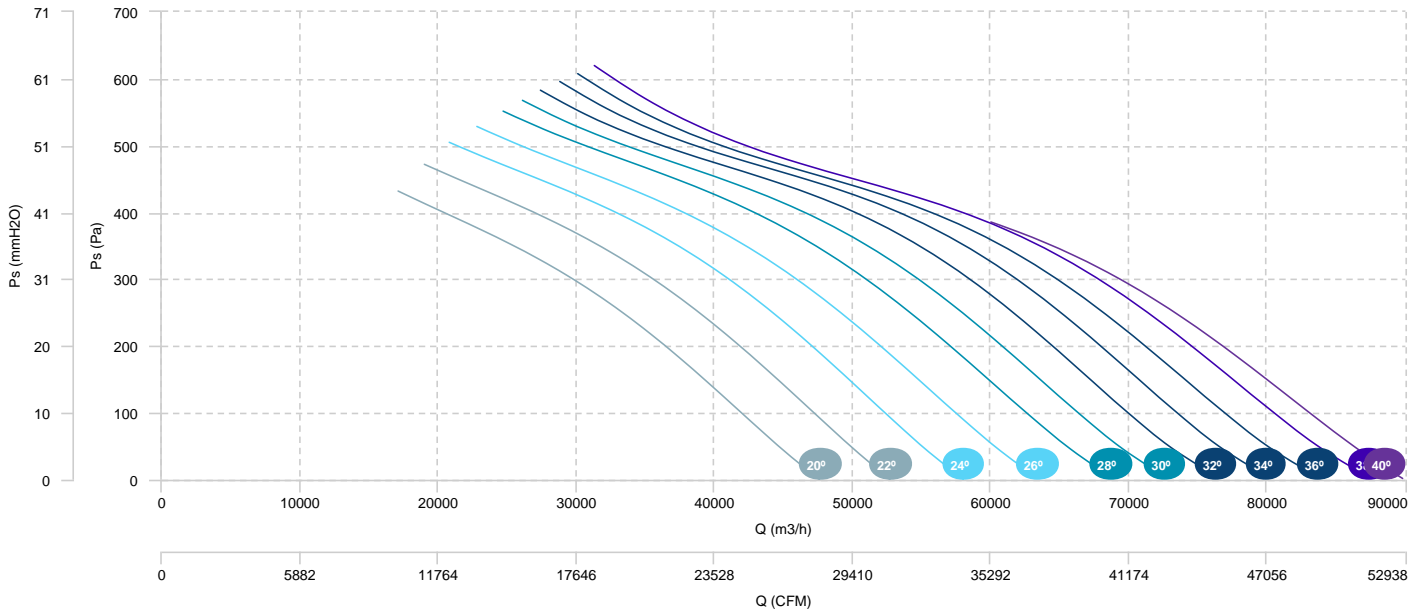

AIR FLOW - ABSORBED POWER (4 POLES)

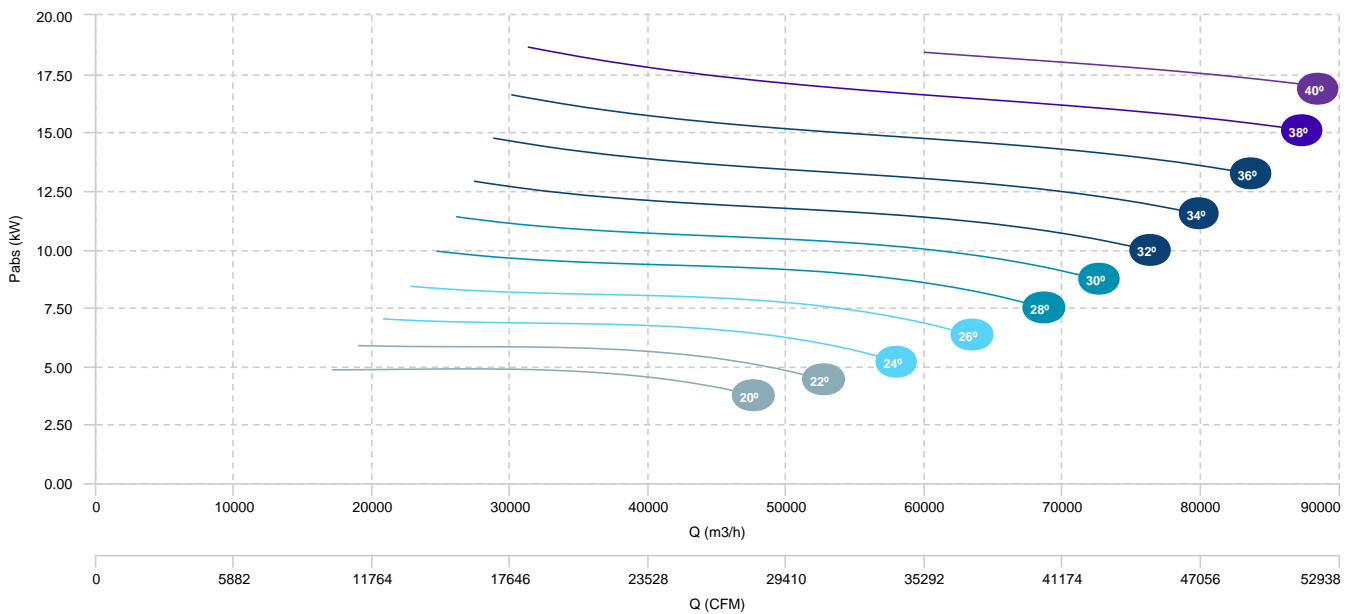

HC 112 T4/T8 5,5/1,1kW (A6:3)	HC 112 T4/T8 7,5/1,5kW (A6:3)	HC 112 T4/T8 11/3kW (A6:3)
HC 112 T4/T8 15/3,5kW (A6:3)	HC 112 T4/T8 17/4,3kW (A6:3)	HC 112 T4/T8 20/5kW (A6:3)

AIR FLOW - PRESSURE (8 POLES)

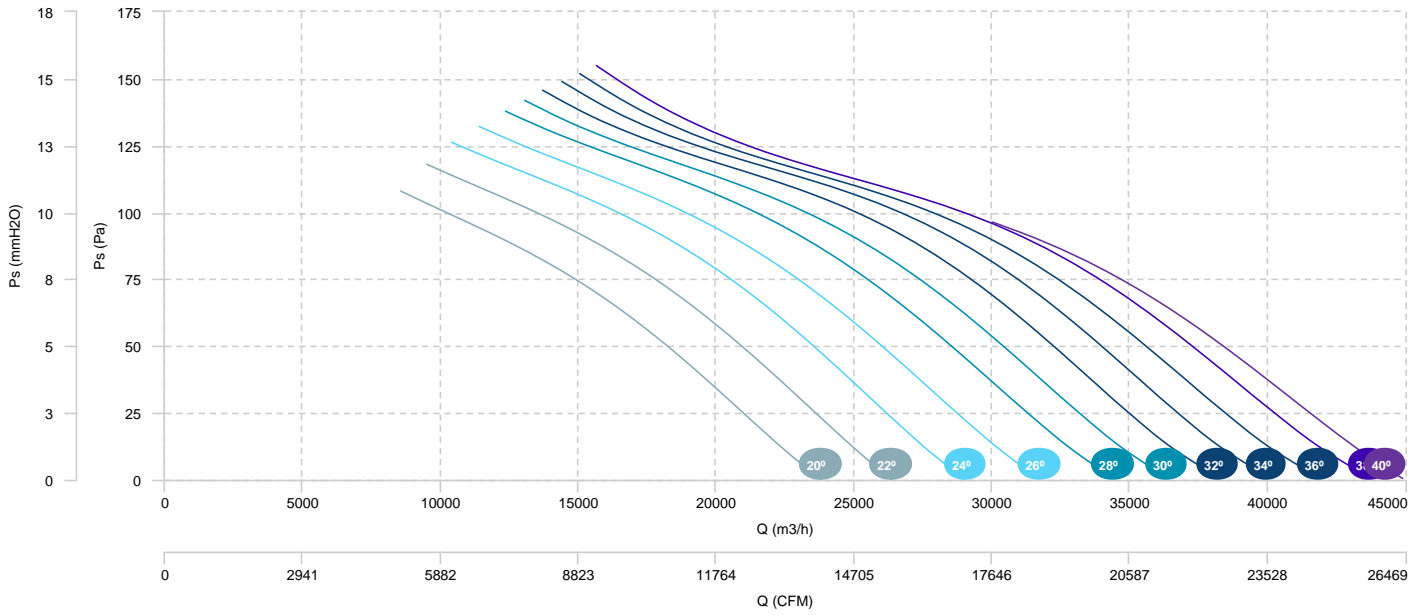

HC 125 T4 15kW (A7:8)	HC 125 T4 18,5kW (A7:8)	HC 125 T4 22kW (A7:8)
HC 125 T4 30kW (A7:8)	HC 125 T4 37kW (A7:8)	HC 125 T4 45kW (A7:8)

AIR FLOW - PRESSURE

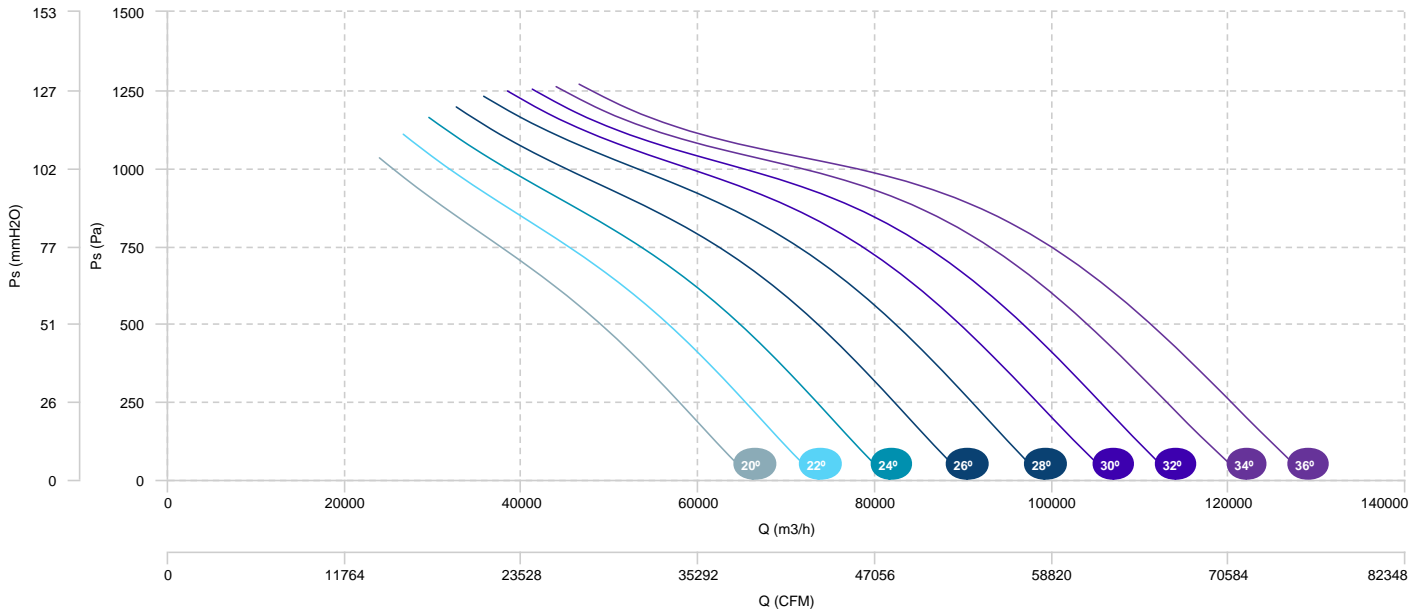

AIR FLOW - ABSORBED POWER

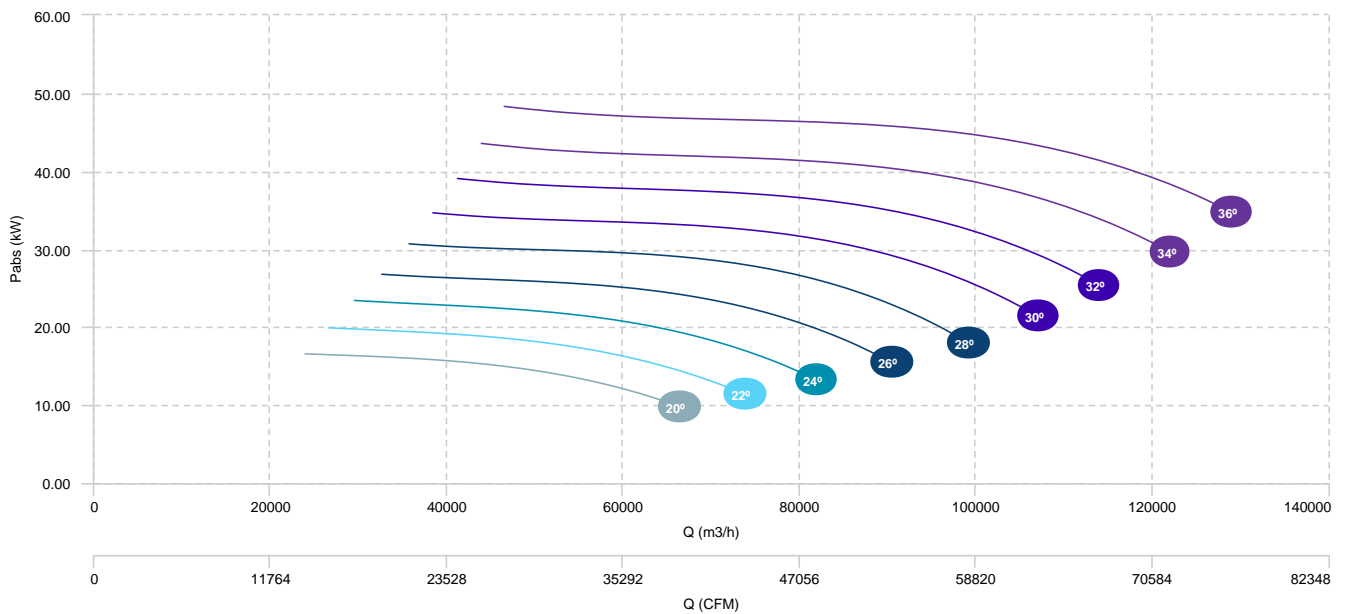

HC 125 T4 11kW (A7:4)	HC 125 T4 15kW (A7:4)	HC 125 T4 18,5kW (A7:4)
HC 125 T4 22kW (A7:4)	HC 125 T4 30kW (A7:4)	HC 125 T4 37kW (A7:4)

AIR FLOW - PRESSURE

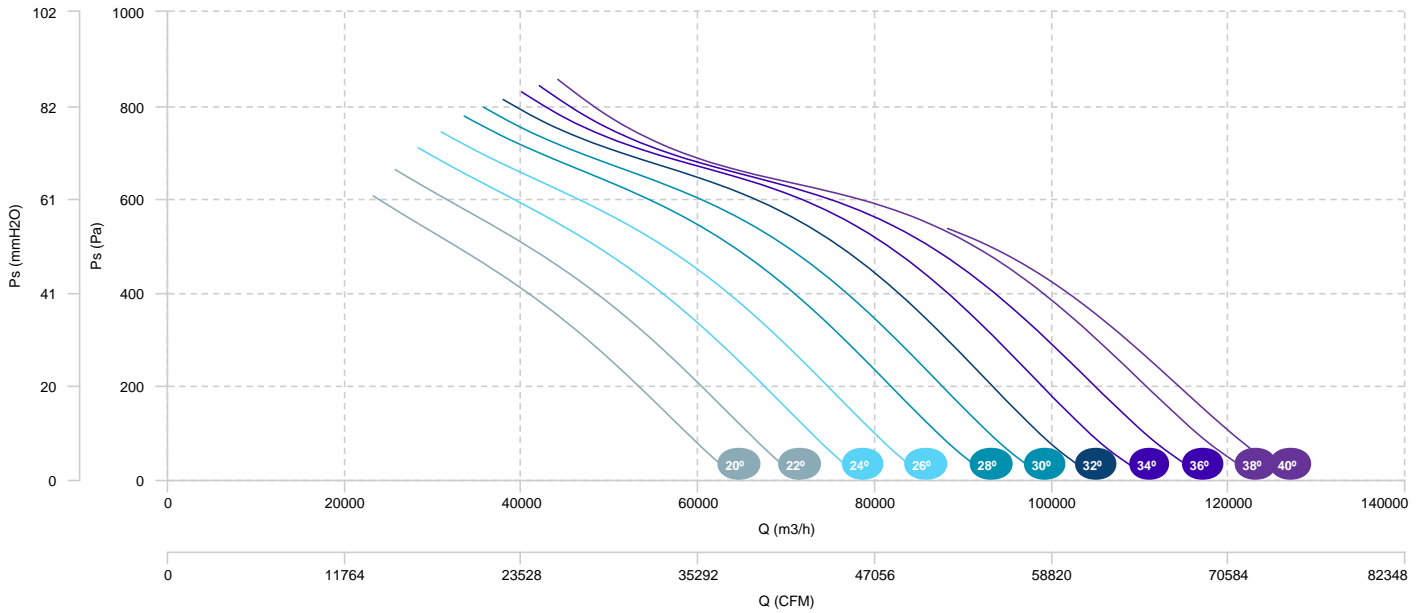

AIR FLOW - ABSORBED POWER

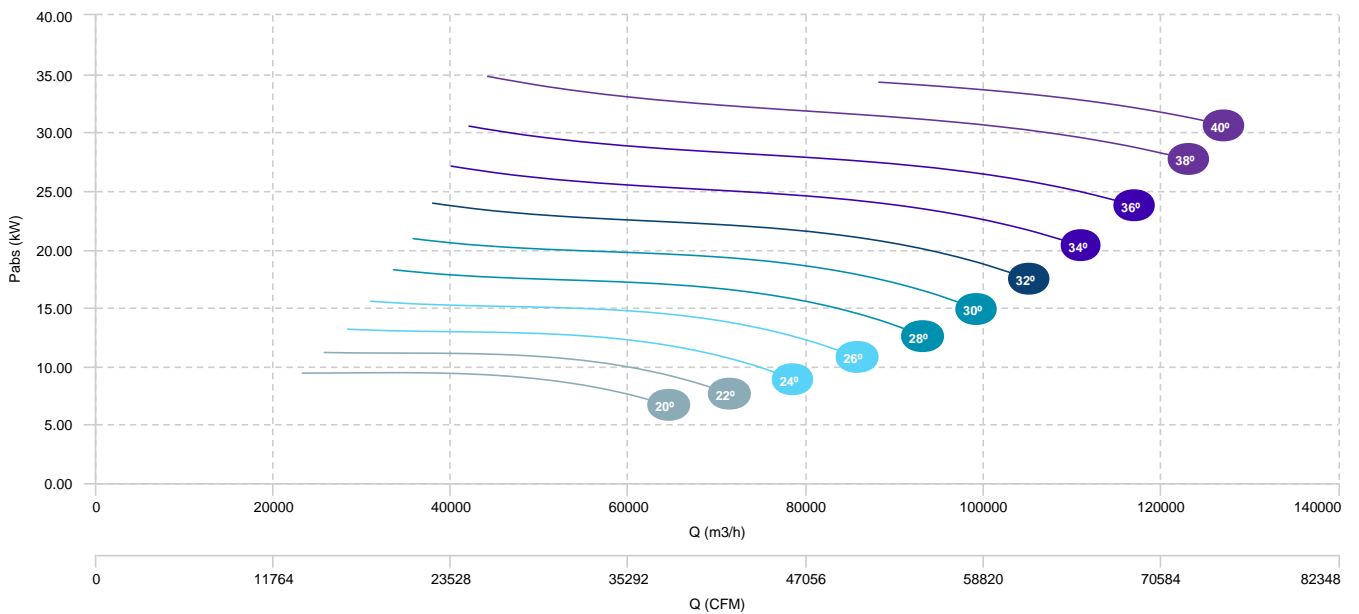

- HC 125 T6 5,5kW (A7:8)
- HC 125 T6 7,5kW (A7:8)
- HC 125 T6 11kW (A7:8)
- HC 125 T6 15kW (A7:8)

AIR FLOW - PRESSURE

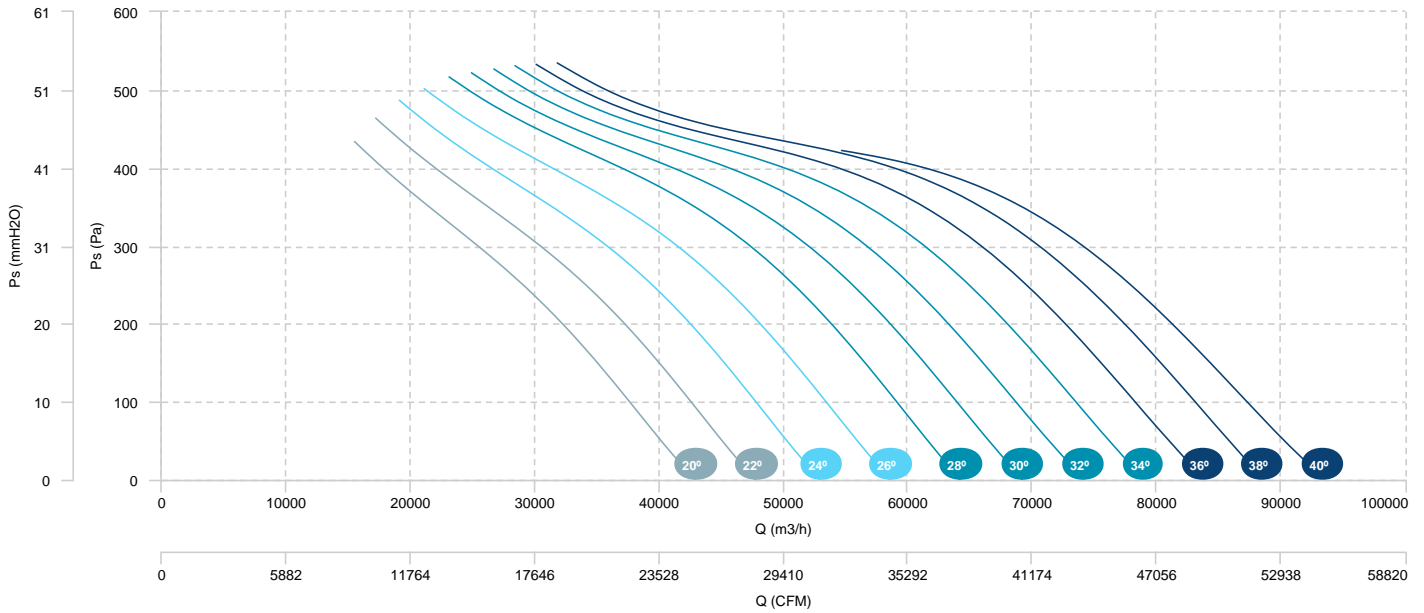

AIR FLOW - ABSORBED POWER

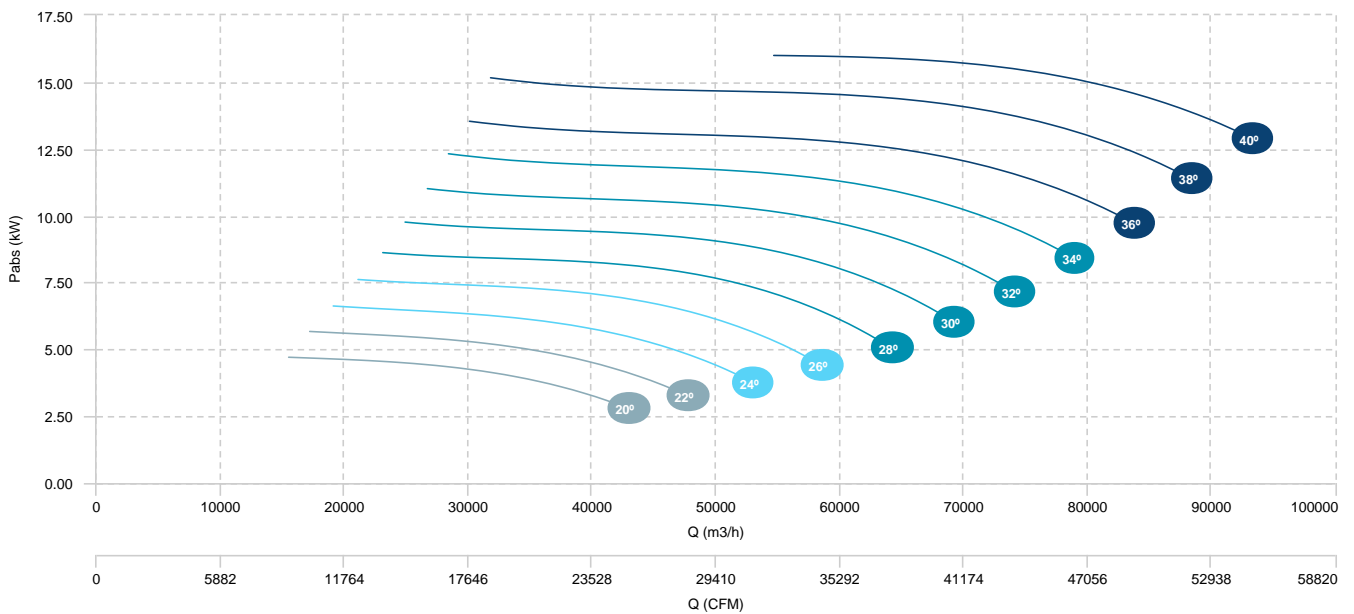

HC 125 T6 3kW (A7:4)	HC 125 T6 4kW (A7:4)	HC 125 T6 5,5kW (A7:4)
HC 125 T6 7,5kW (A7:4)	HC 125 T6 11kW (A7:4)	

AIR FLOW - PRESSURE

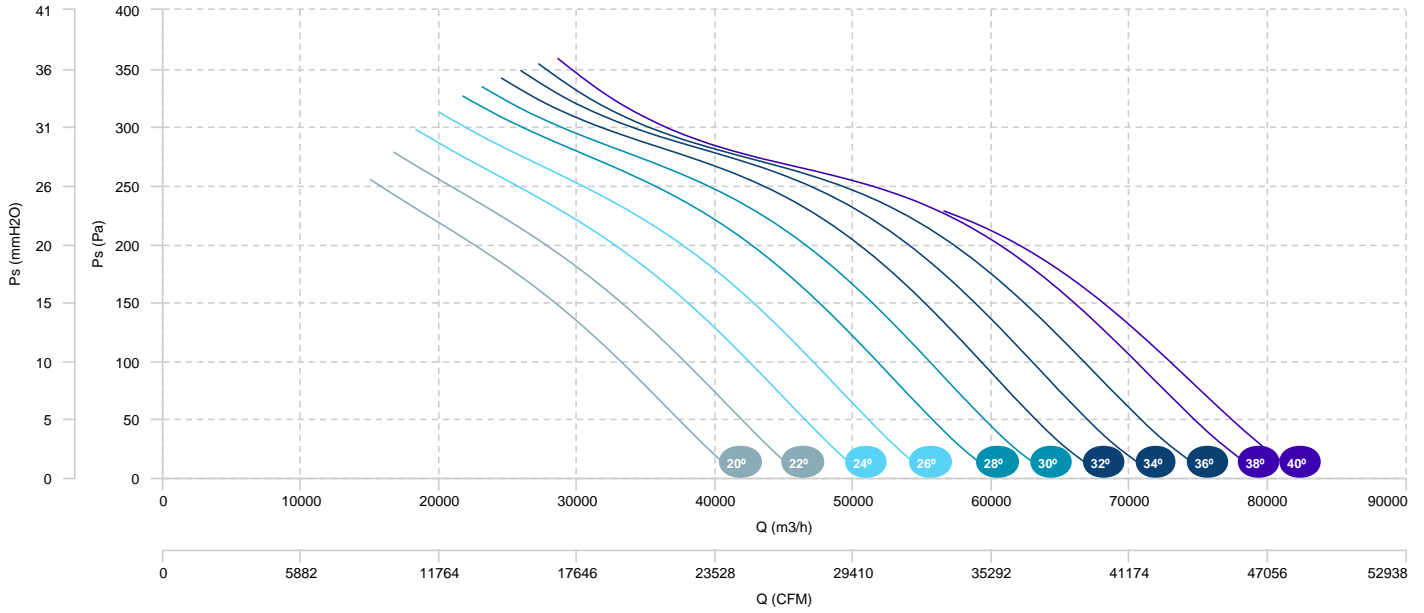

AIR FLOW - ABSORBED POWER

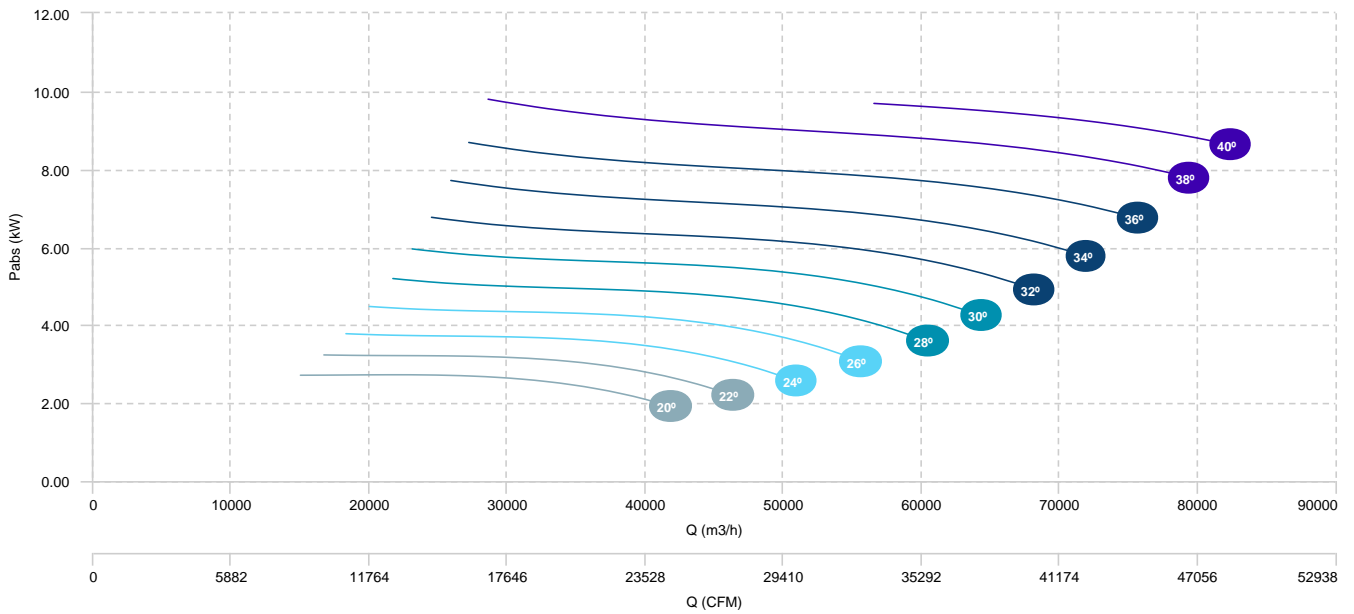

HC 125 T4/T6 15/4,4kW (A7:8)

HC 125 T4/T6 18,5/6kW (A7:8)

HC 125 T4/T6 22/7,5kW (A7:8)

AIR FLOW - PRESSURE (4 POLES)

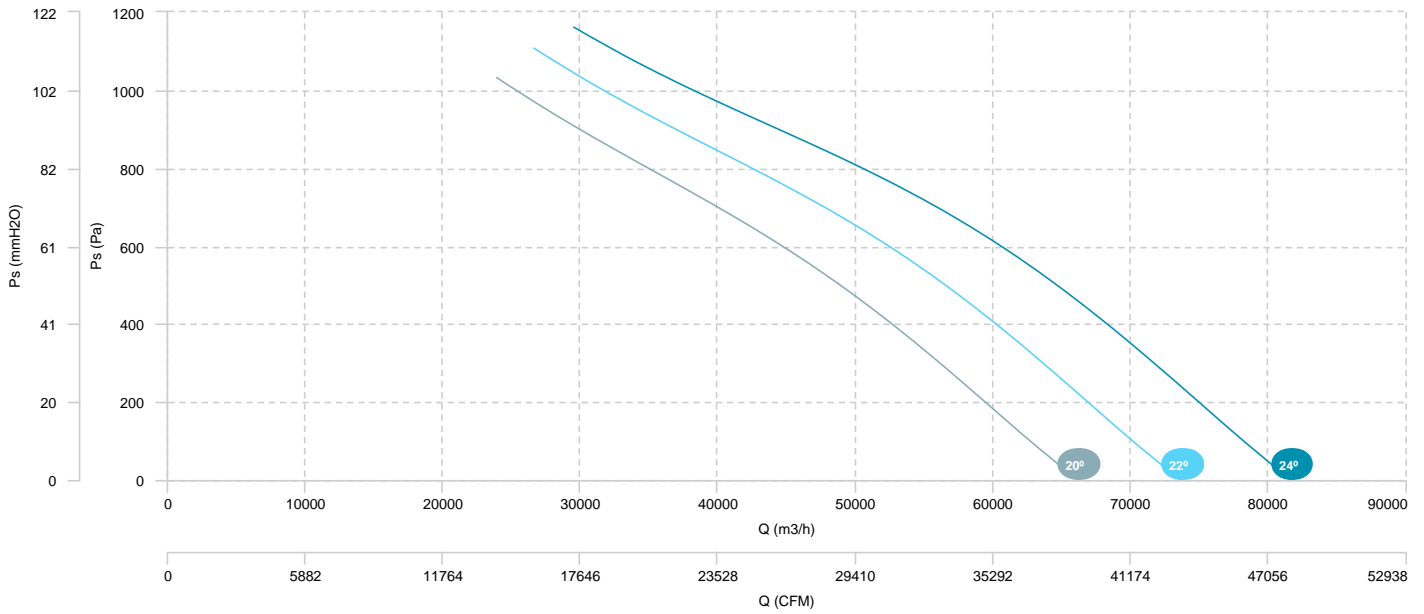

AIR FLOW - ABSORBED POWER (4 POLES)

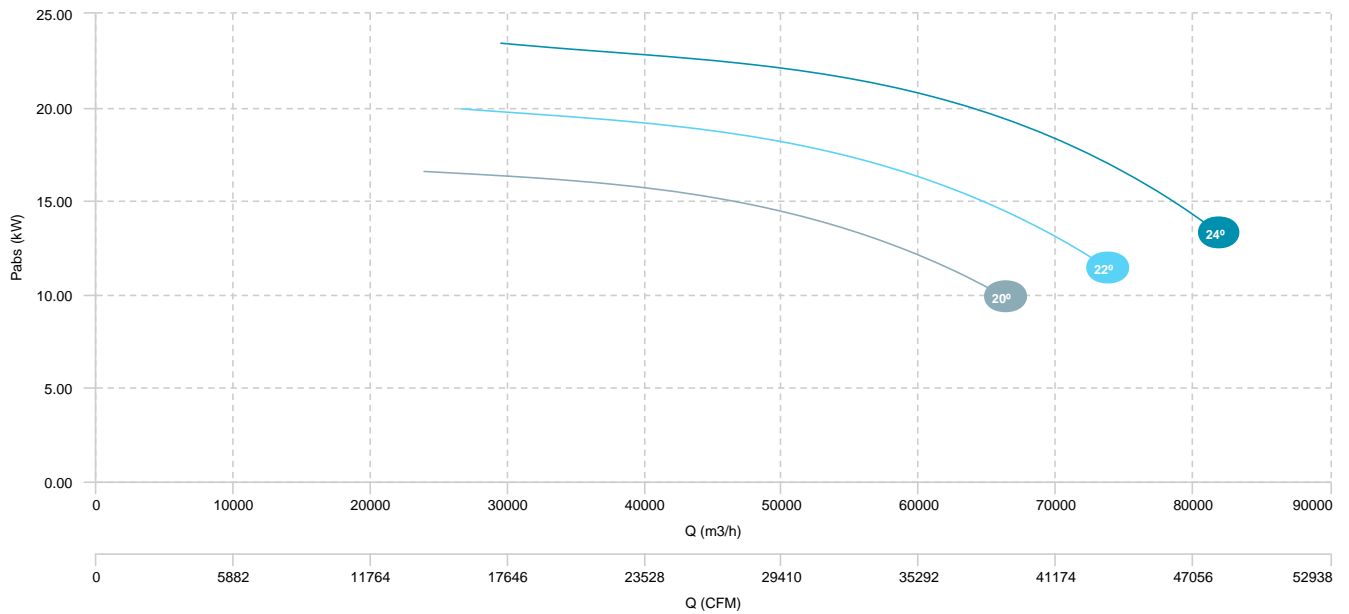

HC 125 T4/T6 15/4,4kW (A7:8)

HC 125 T4/T6 18,5/6kW (A7:8)

HC 125 T4/T6 22/7,5kW (A7:8)

AIR FLOW - PRESSURE (6 POLES)

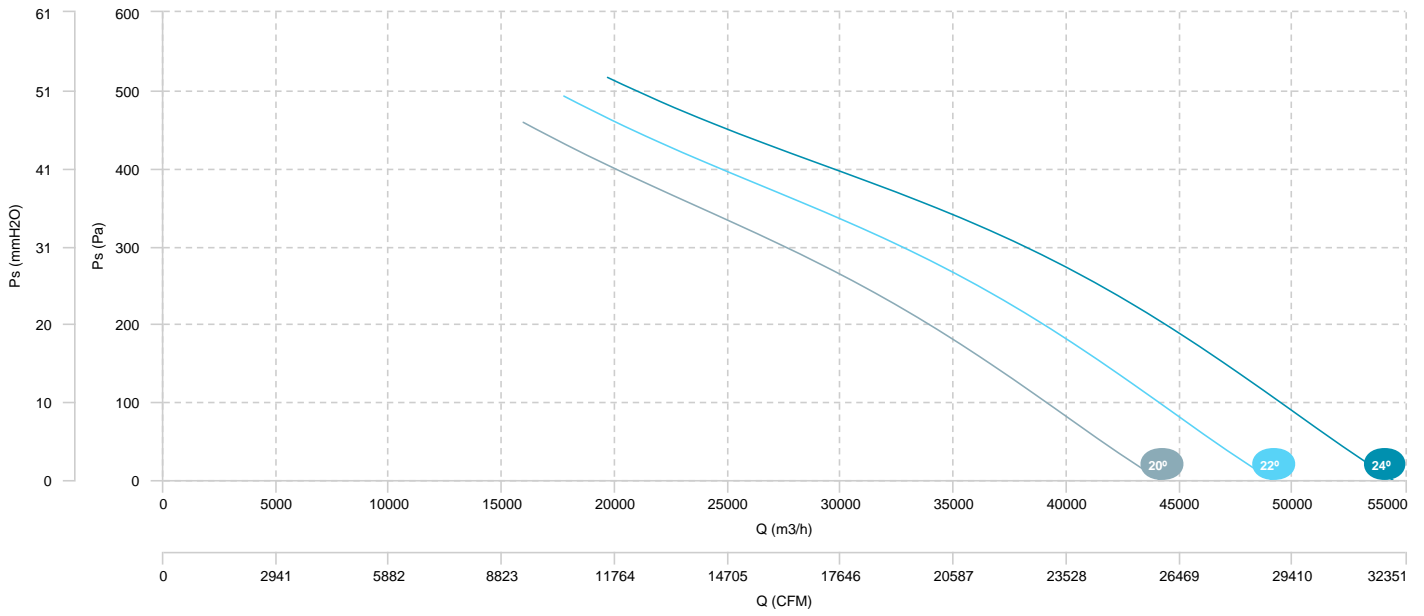

HC 125 T4/T6 11/3,6kW (A7:4)
 HC 125 T4/T6 22/7,5kW (A7:4)

HC 125 T4/T6 15/4,4kW (A7:4)

HC 125 T4/T6 18,5/6kW (A7:4)

AIR FLOW - PRESSURE (4 POLES)

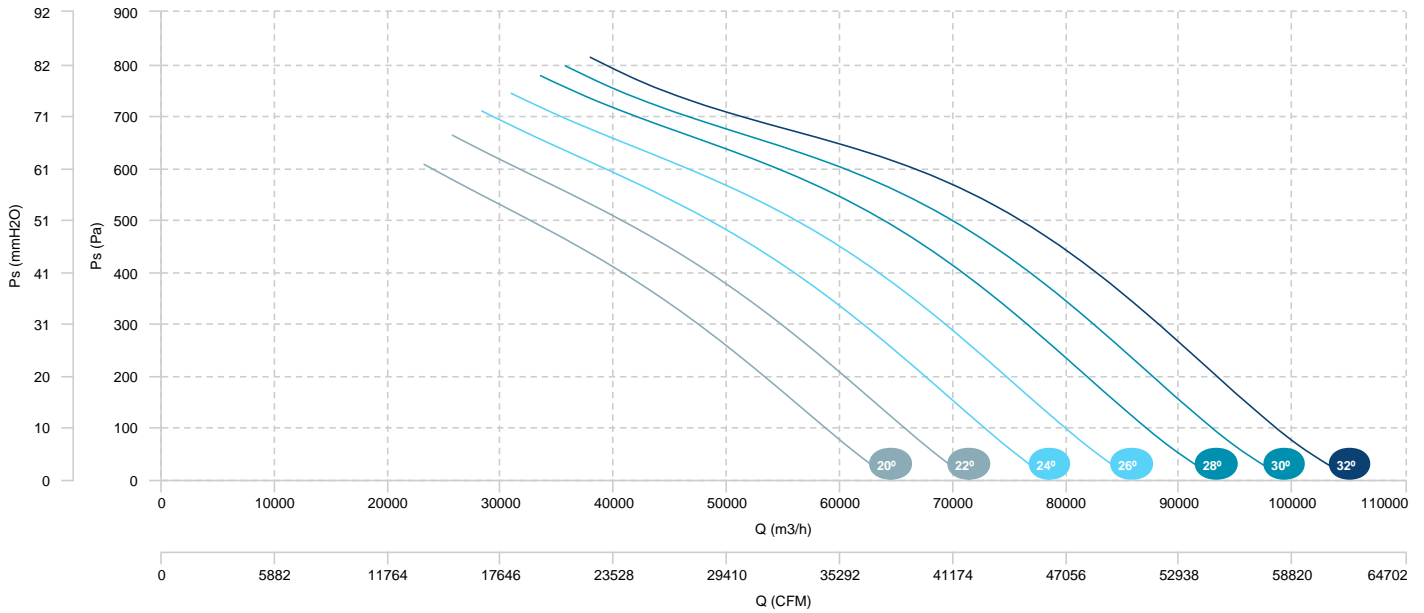

AIR FLOW - ABSORBED POWER (4 POLES)

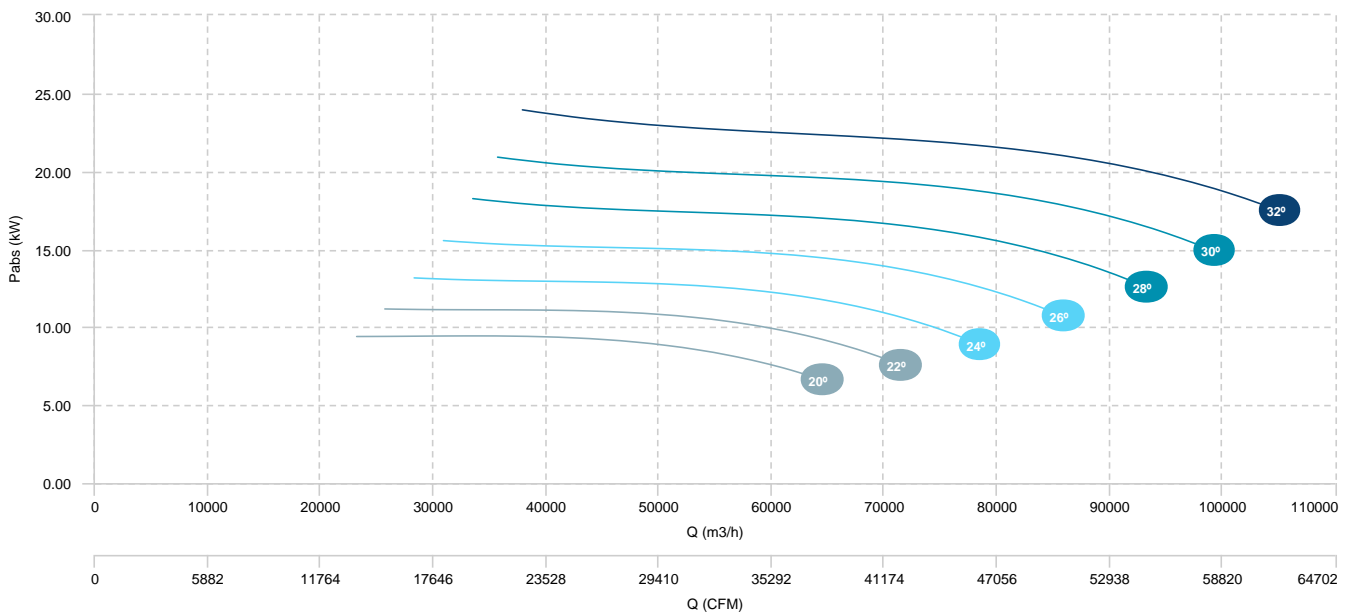

HC 125 T4/T6 11/3,6kW (A7:4)	HC 125 T4/T6 15/4,4kW (A7:4)	HC 125 T4/T6 18,5/6kW (A7:4)
HC 125 T4/T6 22/7,5kW (A7:4)		

AIR FLOW - PRESSURE (6 POLES)

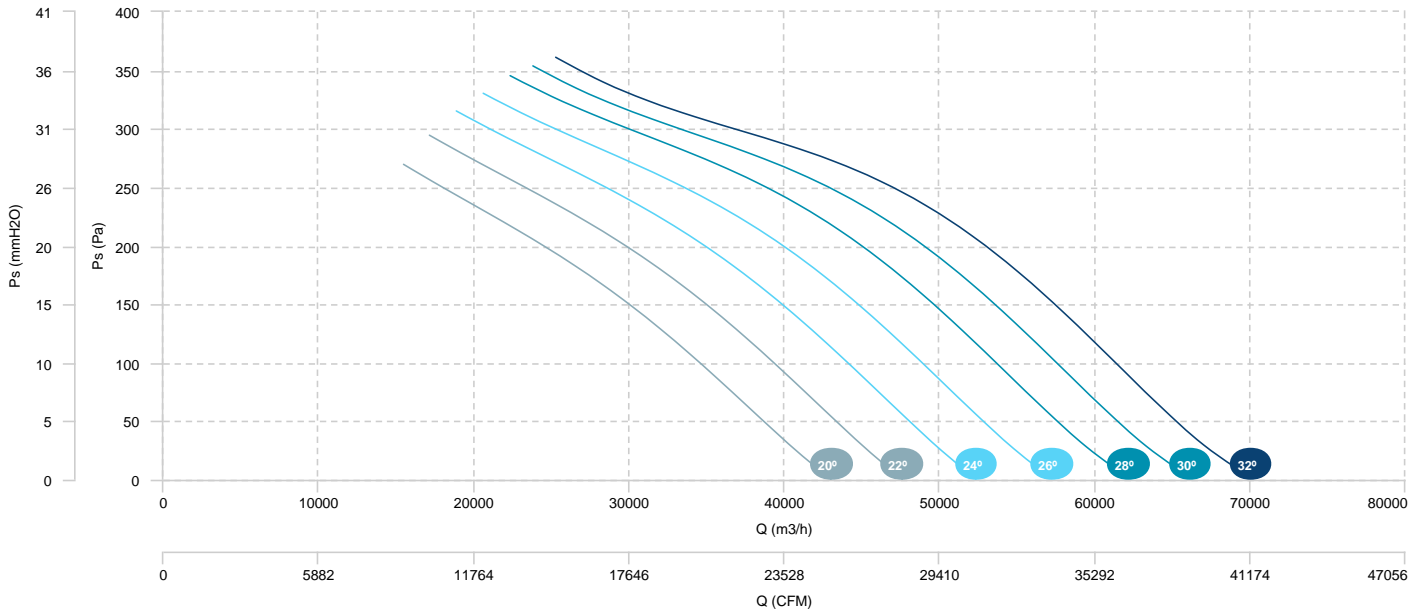

HC 125 T4/T8 15/3,5kW (A7:8)	HC 125 T4/T8 20/5kW (A7:8)	HC 125 T4/T8 28/6,5kW (A7:8)
HC 125 T4/T8 35/8kW (A7:8)	HC 125 T4/T8 37/9,2kW (A7:8)	HC 125 T4/T8 44/11kW (A7:8)

AIR FLOW - PRESSURE (4 POLES)

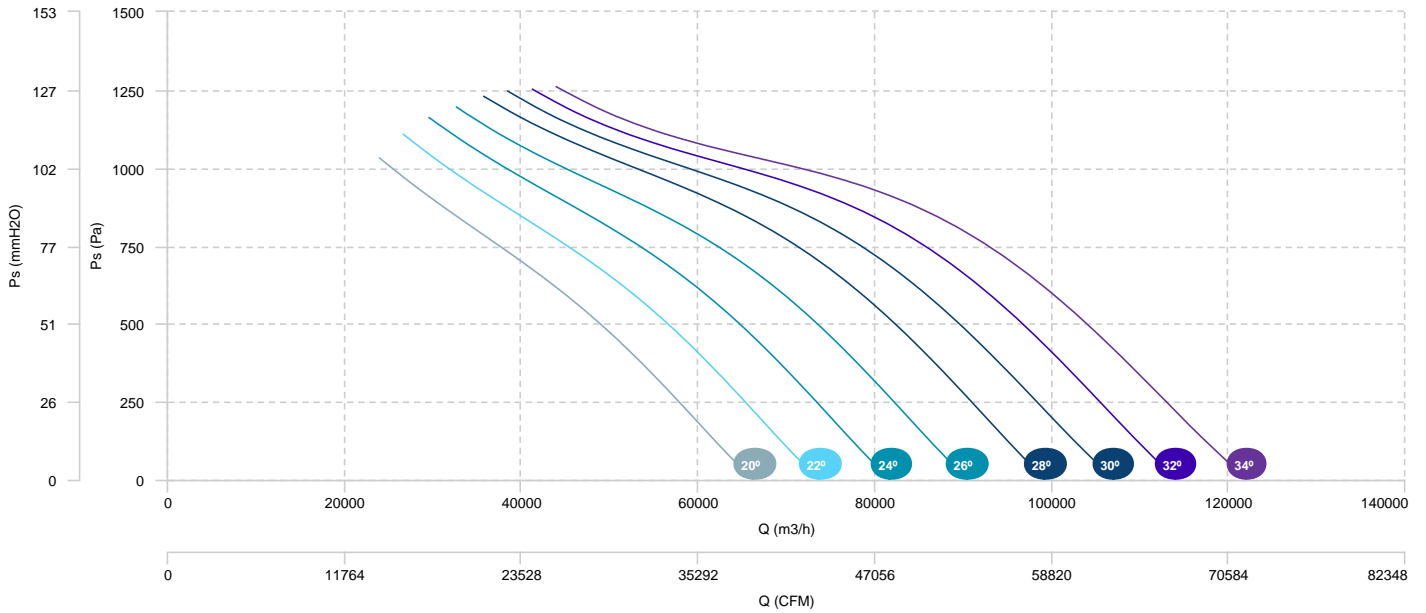

AIR FLOW - ABSORBED POWER (4 POLES)

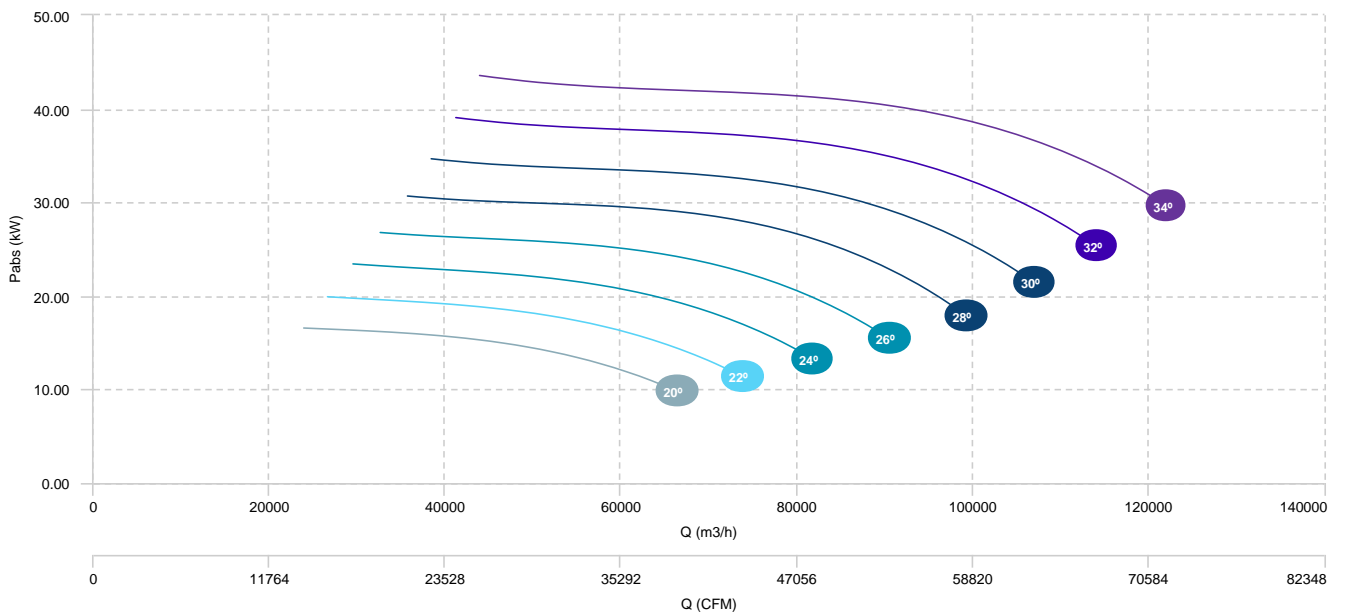

HC 125 T4/T8 15/3,5kW (A7:8)	HC 125 T4/T8 20/5kW (A7:8)	HC 125 T4/T8 28/6,5kW (A7:8)
HC 125 T4/T8 35/8kW (A7:8)	HC 125 T4/T8 37/9,2kW (A7:8)	HC 125 T4/T8 44/11kW (A7:8)

AIR FLOW - PRESSURE (8 POLES)

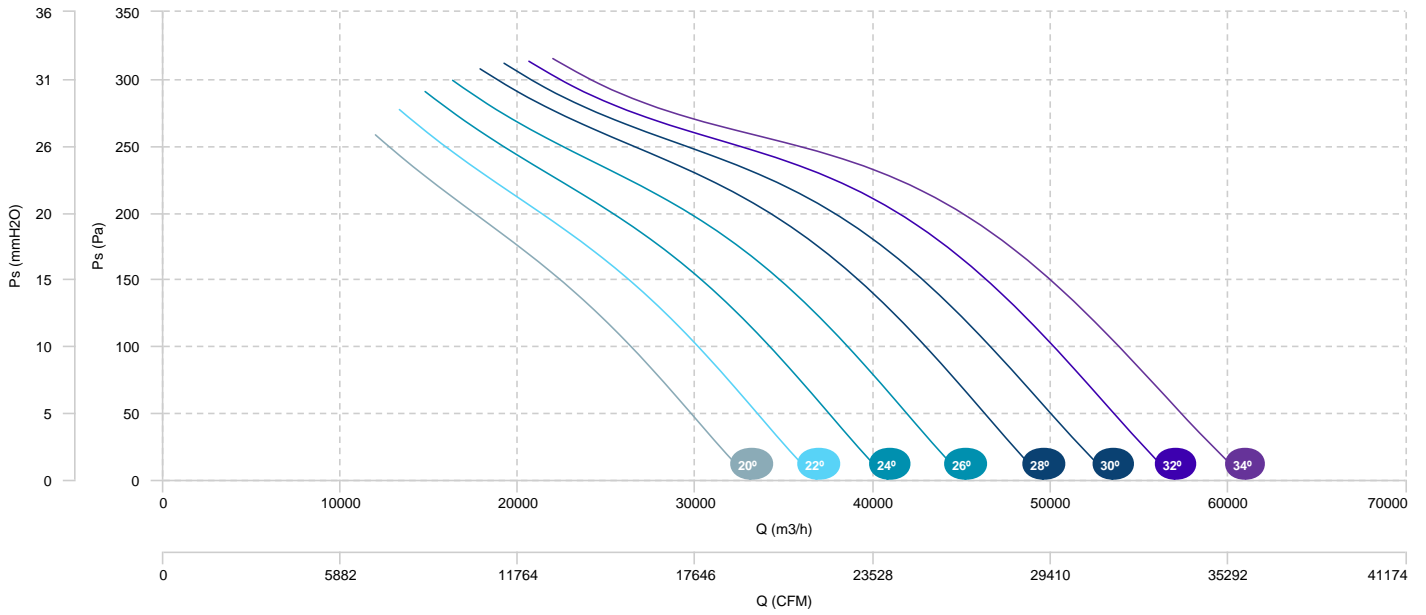

HC 125 T4/T8 11/3kW (A7:4)	HC 125 T4/T8 15/3,5kW (A7:4)	HC 125 T4/T8 17/4,3kW (A7:4)
HC 125 T4/T8 20/5kW (A7:4)	HC 125 T4/T8 28/6,5kW (A7:4)	HC 125 T4/T8 35/8kW (A7:4)

AIR FLOW - PRESSURE (4 POLES)

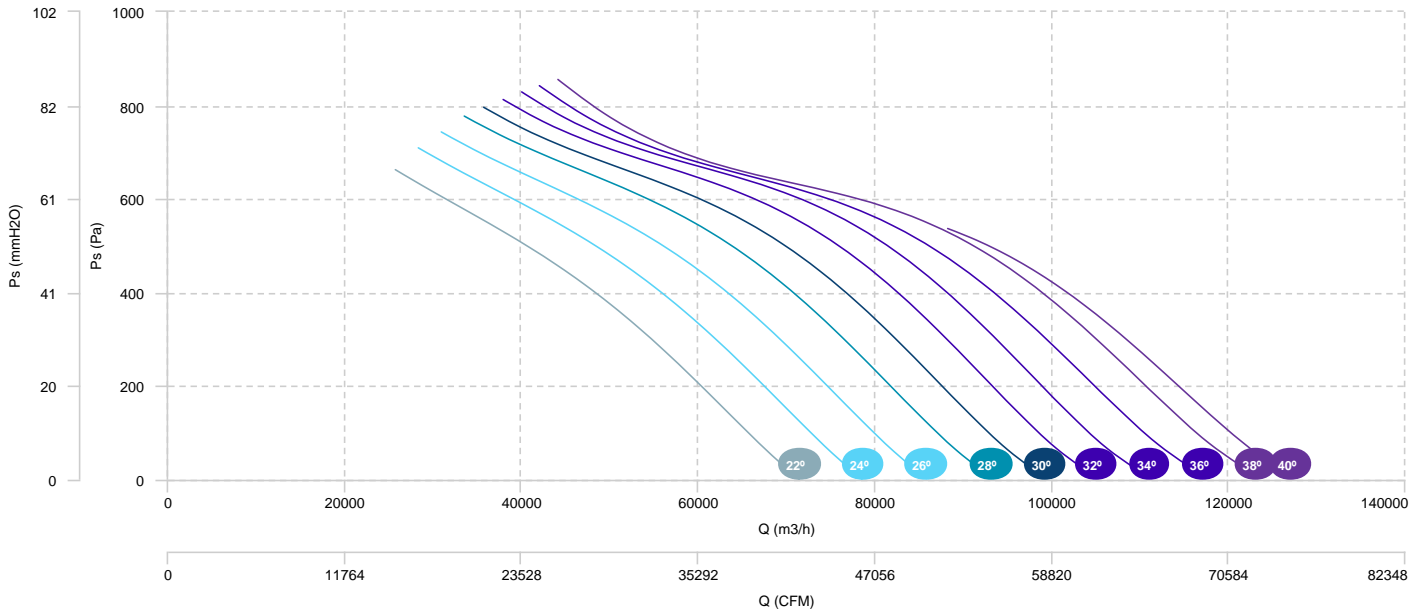

AIR FLOW - ABSORBED POWER (4 POLES)

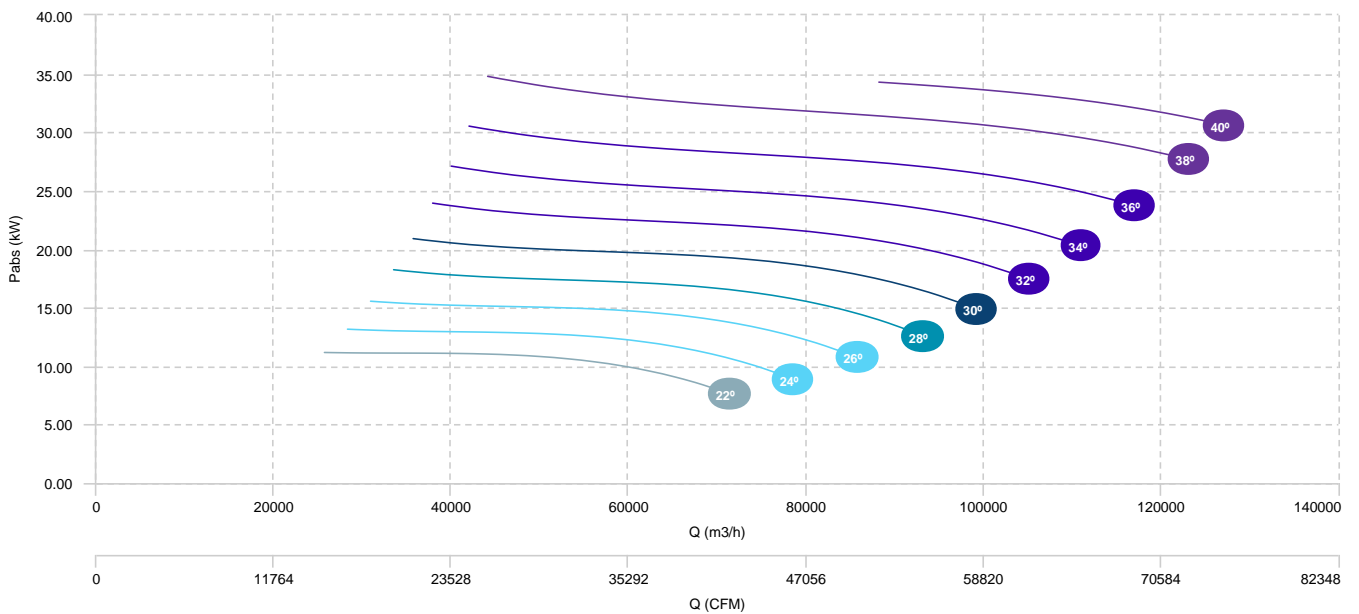

HC 125 T4/T8 11/3kW (A7:4)	HC 125 T4/T8 15/3,5kW (A7:4)	HC 125 T4/T8 17/4,3kW (A7:4)
HC 125 T4/T8 20/5kW (A7:4)	HC 125 T4/T8 28/6,5kW (A7:4)	HC 125 T4/T8 35/8kW (A7:4)

AIR FLOW - PRESSURE (8 POLES)

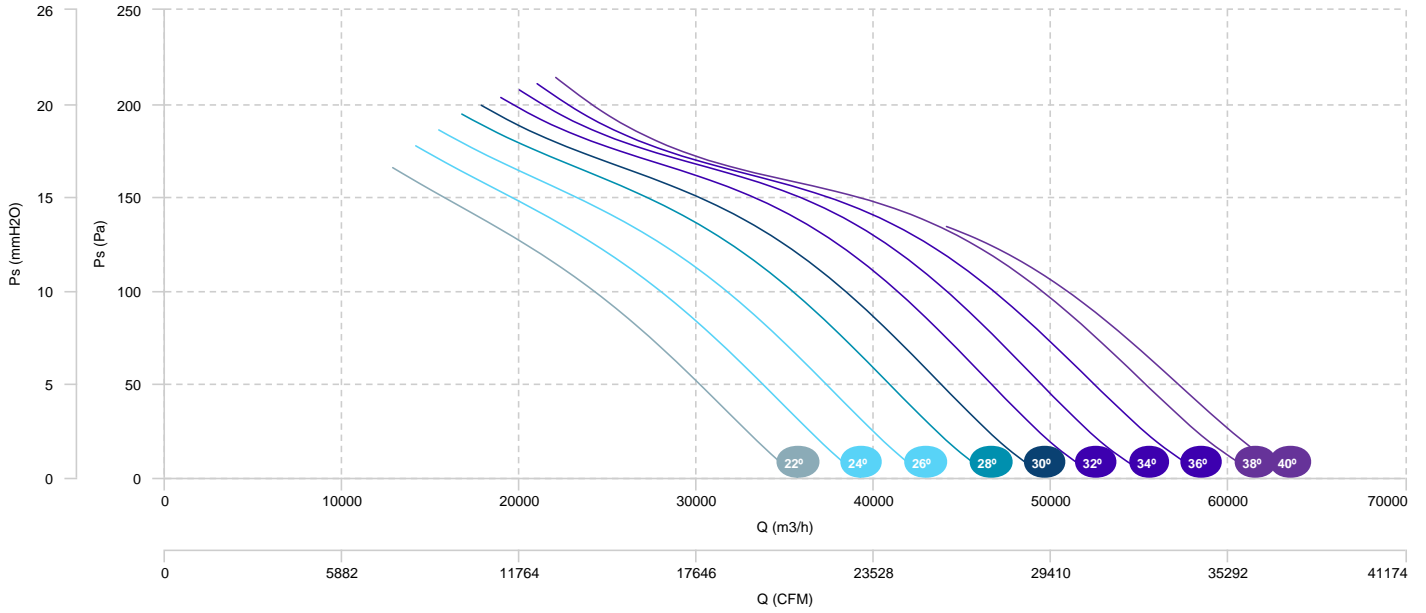

SOUND DATA

SOUND / 2 poles

SOUND POWER Lw dB (A)										
Model		63 Hz	125 Hz	250 Hz	500 Hz	1000 Hz	2000 Hz	4000 Hz	8000 Hz	Total
HC 35 M2 0,55kW (A0:6) (30°)	Inlet	56	65	71	77	78	78	80	75	85
HC 35 M2 1,1kW (A0:6) (35°)	Inlet	55	63	70	73	76	76	78	73	83
HC 35 T2 0,55kW (A0:6) (30°)	Inlet	56	65	71	77	78	78	80	75	85
HC 35 T2 1,1kW (A0:6) (35°)	Inlet	55	63	70	73	76	76	78	73	83
HC 40 T2 1,1kW (A0:6) (30°)	Inlet	61	68	73	77	80	82	83	75	87
HC 45 T2 1,5kW (A0:6) (25°)	Inlet	62	71	76	83	88	88	89	85	94
HC 45 T2 2,2kW (A0:6) (35°)	Inlet	62	69	74	79	82	82	84	78	89

SOUND / 4 poles

SOUND POWER Lw dB (A)										
Model		63 Hz	125 Hz	250 Hz	500 Hz	1000 Hz	2000 Hz	4000 Hz	8000 Hz	Total
HC 35 M4 0,12kW (A0:6) (40°)	Inlet	40	48	54	59	61	62	63	57	68
HC 35 T4 0,12kW (A0:6) (40°)	Inlet	40	48	54	59	61	62	63	57	68
HC 40 M4 0,25kW (A0:6) (40°)	Inlet	48	55	60	64	67	68	68	62	74
HC 40 T4 0,25kW (A0:6) (40°)	Inlet	48	55	60	64	67	68	68	62	74
HC 45 M4 0,37kW (A0:6) (40°)	Inlet	39	57	69	74	76	70	63	58	79
HC 45 T4 0,55kW (A0:6) (45°)	Inlet	50	57	63	67	69	70	70	64	76
HC 50 M4 0,55kW (A0:6) (40°)	Inlet	51	59	64	68	71	72	72	65	78
HC 50 T4 0,55kW (A0:6) (45°)	Inlet	51	59	64	68	71	72	72	65	78
HC 56 M4 0,37kW (A5:6) (20°)	Inlet	52	60	67	74	80	75	77	69	84
HC 56 M4 0,55kW (A2:6) (20°)	Inlet	46	54	64	73	75	75	76	72	82
HC 56 M4 0,55kW (A2:6) (25°)	Inlet	50	57	65	73	75	76	77	72	82
HC 56 M4 0,55kW (A5:6) (25°)	Inlet	54	62	67	75	79	76	78	70	84
HC 56 T4 0,37kW (A5:6) (20°)	Inlet	52	60	67	74	80	75	77	69	84
HC 56 T4 0,55kW (A2:6) (20°)	Inlet	46	54	64	73	75	75	76	72	82
HC 56 T4 0,55kW (A2:6) (25°)	Inlet	50	57	65	73	75	76	77	72	82
HC 56 T4 0,55kW (A2:9) (20°)	Inlet	54	58	67	73	76	76	77	69	82
HC 56 T4 0,55kW (A5:6) (25°)	Inlet	54	62	67	75	79	76	78	70	84
HC 56 T4 0,75kW (A2:6) (27,5°)	Inlet	51	58	65	72	74	75	76	70	81
HC 56 T4 0,75kW (A2:6) (30°)	Inlet	52	59	65	71	73	74	76	70	80
HC 56 T4 0,75kW (A2:6) (32,5°)	Inlet	53	60	65	71	73	75	75	70	80
HC 56 T4 0,75kW (A2:9) (25°)	Inlet	53	58	67	73	76	76	77	71	82
HC 56 T4 0,75kW (A5:6) (30°)	Inlet	56	63	68	77	78	78	80	72	85
HC 56 T4 0,75kW (A5:6) (32,5°)	Inlet	54	61	66	75	75	76	79	70	83
HC 56 T4 1,1kW (A2:6) (35°)	Inlet	52	59	64	71	73	75	75	70	80

SOUND POWER Lw dB (A)

Model		63 Hz	125 Hz	250 Hz	500 Hz	1000 Hz	2000 Hz	4000 Hz	8000 Hz	Total
HC 56 T4 1,1kW (A2:6) (37,5°)	Inlet	53	60	65	71	73	75	76	70	81
HC 56 T4 1,1kW (A2:6) (40°)	Inlet	54	61	66	71	74	75	76	70	81
HC 56 T4 1,1kW (A2:6) (42,5°)	Inlet	55	61	67	72	74	76	76	70	81
HC 56 T4 1,1kW (A2:9) (27,5°)	Inlet	54	59	67	73	76	77	78	72	83
HC 56 T4 1,1kW (A2:9) (30°)	Inlet	54	59	67	73	77	77	78	73	83
HC 56 T4 1,1kW (A2:9) (32,5°)	Inlet	53	59	68	73	76	77	78	73	83
HC 56 T4 1,1kW (A2:9) (35°)	Inlet	53	59	68	73	76	77	79	73	83
HC 56 T4 1,1kW (A5:6) (35°)	Inlet	53	60	65	74	73	75	78	69	82
HC 56 T4 1,1kW (A5:6) (37,5°)	Inlet	54	61	66	75	74	76	78	69	82
HC 56 T4 1,5kW (A2:6) (45°)	Inlet	56	60	68	72	75	77	76	71	82
HC 56 T4 1,5kW (A2:9) (37,5°)	Inlet	53	59	68	73	76	77	78	73	83
HC 56 T4 1,5kW (A2:9) (40°)	Inlet	53	60	69	73	76	77	78	72	83
HC 56 T4 1,5kW (A2:9) (42,5°)	Inlet	53	60	69	73	76	77	78	72	83
HC 56 T4 1,5kW (A5:6) (40°)	Inlet	56	63	68	76	75	76	79	70	83
HC 63 T4 0,55kW (A2:6) (20°)	Inlet	49	51	64	74	73	73	75	70	80
HC 63 T4 0,75kW (A2:6) (25°)	Inlet	53	58	67	75	76	77	78	73	83
HC 63 T4 0,75kW (A2:9) (20°)	Inlet	57	60	71	77	78	77	79	74	85
HC 63 T4 0,75kW (A5:6) (25°)	Inlet	57	66	71	80	80	79	80	75	86
HC 63 T4 1,1kW (A2:6) (27,5°)	Inlet	53	59	67	74	76	77	78	73	83
HC 63 T4 1,1kW (A2:6) (30°)	Inlet	53	60	66	74	75	77	78	73	83
HC 63 T4 1,1kW (A2:6) (32,5°)	Inlet	53	61	66	73	75	77	77	72	82
HC 63 T4 1,1kW (A2:9) (25°)	Inlet	57	61	70	76	78	78	80	74	85
HC 63 T4 1,1kW (A5:6) (30°)	Inlet	60	68	74	80	80	79	82	77	87
HC 63 T4 1,5kW (A2:6) (35°)	Inlet	53	60	65	72	74	77	77	72	82
HC 63 T4 1,5kW (A2:6) (37,5°)	Inlet	54	61	66	73	75	77	77	72	82
HC 63 T4 1,5kW (A2:6) (40°)	Inlet	55	62	67	73	76	77	77	72	83
HC 63 T4 1,5kW (A2:9) (27,5°)	Inlet	58	62	70	76	78	79	80	75	85
HC 63 T4 1,5kW (A2:9) (30°)	Inlet	58	63	70	76	78	80	81	75	86
HC 63 T4 1,5kW (A2:9) (32,5°)	Inlet	57	63	70	77	79	80	81	75	86
HC 63 T4 1,5kW (A5:6) (32,5°)	Inlet	59	68	73	77	78	77	80	75	85
HC 63 T4 1,5kW (A5:6) (35°)	Inlet	59	67	72	75	76	76	79	73	83
HC 63 T4 2,2kW (A2:6) (42,5°)	Inlet	56	62	68	74	76	78	78	72	83
HC 63 T4 2,2kW (A2:6) (45°)	Inlet	58	62	70	74	78	78	78	72	84
HC 63 T4 2,2kW (A2:9) (35°)	Inlet	57	63	70	77	79	80	81	76	86
HC 63 T4 2,2kW (A2:9) (37,5°)	Inlet	57	63	70	76	79	80	81	76	86
HC 63 T4 2,2kW (A2:9) (40°)	Inlet	57	63	69	76	79	80	80	76	86
HC 63 T4 2,2kW (A2:9) (42,5°)	Inlet	57	64	69	76	79	80	81	76	86
HC 63 T4 2,2kW (A5:6) (37,5°)	Inlet	59	67	72	76	77	77	79	73	84
HC 63 T4 2,2kW (A5:6) (40°)	Inlet	60	67	72	77	78	78	80	73	85

SOUND POWER Lw dB (A)

Model		63 Hz	125 Hz	250 Hz	500 Hz	1000 Hz	2000 Hz	4000 Hz	8000 Hz	Total
HC 63 T4 3kW (A2:9) (45°)	Inlet	57	64	69	76	78	80	81	75	86
HC 71 T4 0,75kW (A2:6) (20°)	Inlet	55	61	72	79	83	82	84	78	89
HC 71 T4 0,75kW (A5:6) (20°)	Inlet	55	66	71	86	85	82	84	76	91
HC 71 T4 1,1kW (A2:6) (25°)	Inlet	57	63	71	79	81	82	83	77	88
HC 71 T4 1,1kW (A2:9) (20°)	Inlet	60	66	75	83	85	85	87	79	91
HC 71 T4 1,1kW (A5:6) (25°)	Inlet	59	67	72	84	84	82	84	75	90
HC 71 T4 1,5kW (A2:6) (27,5°)	Inlet	57	64	70	78	80	81	82	77	87
HC 71 T4 1,5kW (A2:6) (30°)	Inlet	58	64	70	78	79	81	82	77	87
HC 71 T4 1,5kW (A2:6) (32,5°)	Inlet	57	64	69	76	78	80	81	75	86
HC 71 T4 1,5kW (A2:9) (25°)	Inlet	60	67	74	81	83	84	85	79	90
HC 71 T4 1,5kW (A5:6) (30°)	Inlet	61	68	73	82	82	83	84	73	89
HC 71 T4 2,2kW (A2:6) (35°)	Inlet	57	64	69	75	77	79	80	74	85
HC 71 T4 2,2kW (A2:6) (37,5°)	Inlet	58	65	70	76	78	80	80	74	85
HC 71 T4 2,2kW (A2:6) (40°)	Inlet	59	66	71	77	80	81	80	74	86
HC 71 T4 2,2kW (A2:9) (27,5°)	Inlet	60	67	73	80	82	83	84	78	89
HC 71 T4 2,2kW (A2:9) (30°)	Inlet	60	67	72	79	82	83	84	78	89
HC 71 T4 2,2kW (A2:9) (32,5°)	Inlet	60	67	72	79	82	83	83	78	89
HC 71 T4 2,2kW (A5:6) (32,5°)	Inlet	62	69	74	79	81	83	84	73	88
HC 71 T4 2,2kW (A5:6) (35°)	Inlet	62	69	74	76	80	82	83	72	87
HC 71 T4 3kW (A2:6) (42,5°)	Inlet	60	66	72	77	80	81	80	74	86
HC 71 T4 3kW (A2:6) (45°)	Inlet	62	66	74	77	80	81	81	74	86
HC 71 T4 3kW (A2:9) (35°)	Inlet	60	67	72	79	82	83	83	78	89
HC 71 T4 3kW (A2:9) (37,5°)	Inlet	61	68	73	79	82	83	83	78	89
HC 71 T4 3kW (A5:6) (37,5°)	Inlet	65	71	77	79	82	84	85	74	89
HC 71 T4 3kW (A5:6) (40°)	Inlet	67	73	79	81	84	85	86	76	91
HC 80 T4 1,1KW (A2:6) (20°)	Inlet	54	61	71	79	83	83	84	79	89
HC 80 T4 1,5KW (A2:6) (25°)	Inlet	57	64	72	79	83	83	84	79	89
HC 80 T4 1,5KW (A2:9) (20°)	Inlet	60	72	77	89	91	89	92	84	97
HC 80 T4 2,2kW (A2:6) (27,5°)	Inlet	60	67	72	79	82	84	84	78	89
HC 80 T4 2,2kW (A2:6) (30°)	Inlet	60	67	72	79	82	84	84	78	89
HC 80 T4 2,2kW (A2:6) (32,5°)	Inlet	61	68	73	79	82	84	84	77	89
HC 80 T4 2,2kW (A2:9) (25°)	Inlet	62	71	76	86	89	88	90	83	95
HC 80 T4 3kW (A2:6) (35°)	Inlet	62	69	74	78	81	84	84	77	89
HC 80 T4 3kW (A2:6) (37,5°)	Inlet	62	69	74	78	81	83	83	76	88
HC 80 T4 3kW (A2:9) (27,5°)	Inlet	63	71	76	85	88	88	89	82	94
HC 80 T4 3kW (A2:9) (30°)	Inlet	63	70	75	84	87	88	88	82	93
HC 80 T4 3kW (A5:6) (30°)	Inlet	64	71	76	83	87	86	90	83	94
HC 80 T4 3kW (A5:6) (32,5°)	Inlet	63	70	75	81	85	84	88	80	91
HC 80 T4 3kW (A5:6) (35°)	Inlet	62	69	74	79	82	82	86	76	89

SOUND POWER Lw dB (A)

Model		63 Hz	125 Hz	250 Hz	500 Hz	1000 Hz	2000 Hz	4000 Hz	8000 Hz	Total
HC 80 T4 4kW (A2:6) (40°)	Inlet	61	69	74	78	81	82	82	75	88
HC 80 T4 4kW (A2:6) (42,5°)	Inlet	62	69	75	78	81	82	82	75	88
HC 80 T4 4kW (A2:9) (32,5°)	Inlet	63	70	75	83	86	87	87	81	93
HC 80 T4 4kW (A2:9) (35°)	Inlet	62	69	74	81	85	87	86	80	92
HC 80 T4 4kW (A5:6) (37,5°)	Inlet	64	71	76	80	83	83	86	76	90
HC 80 T4 4kW (A5:6) (40°)	Inlet	66	73	78	82	84	84	86	76	91
HC 80 T4 5,5kW (A2:6) (45°)	Inlet	62	69	75	79	82	82	82	75	88
HC 80 T4 5,5kW (A2:9) (37,5°)	Inlet	63	70	75	81	85	87	86	80	91
HC 80 T4 5,5kW (A2:9) (40°)	Inlet	64	71	76	81	84	86	85	79	91
HC 80 T4 5,5kW (A2:9) (42,5°)	Inlet	64	71	76	81	84	86	85	79	91
HC 90 T4 3kW (A6:3) (20°)	Inlet	60	63	72	75	79	80	84	78	87
HC 90 T4 3kW (A6:3) (22°)	Inlet	61	65	73	77	81	82	85	79	89
HC 90 T4 4kW (A6:3) (24°)	Inlet	62	67	75	79	82	83	86	80	90
HC 90 T4 4kW (A6:3) (26°)	Inlet	63	68	76	81	83	84	87	81	91
HC 90 T4 4kW (A6:3) (28°)	Inlet	64	69	77	82	84	85	87	82	92
HC 90 T4 5,5kW (A6:3) (30°)	Inlet	65	71	78	84	85	86	88	82	93
HC 90 T4 5,5kW (A6:3) (32°)	Inlet	65	71	78	86	86	87	88	83	94
HC 90 T4 5,5kW (A6:6) (20°)	Inlet	65	75	81	88	92	90	91	86	97
HC 90 T4 5,5kW (A6:6) (22°)	Inlet	66	75	81	89	92	91	91	86	97
HC 90 T4 7,5kW (A6:3) (34°)	Inlet	66	72	79	87	87	88	89	83	94
HC 90 T4 7,5kW (A6:3) (36°)	Inlet	66	72	79	88	87	89	89	84	95
HC 90 T4 7,5kW (A6:6) (24°)	Inlet	67	76	82	89	92	91	92	87	98
HC 90 T4 7,5kW (A6:6) (26°)	Inlet	67	77	82	90	92	91	92	88	98
HC 90 T4 7,5kW (A6:6) (28°)	Inlet	68	77	83	90	92	92	93	88	98
HC 90 T4 11kW (A6:3) (38°)	Inlet	66	73	80	89	89	90	90	85	96
HC 90 T4 11kW (A6:3) (40°)	Inlet	66	74	81	89	90	91	91	86	97
HC 90 T4 11kW (A6:6) (30°)	Inlet	69	78	83	90	92	92	93	89	99
HC 90 T4 11kW (A6:6) (32°)	Inlet	68	77	82	89	90	90	92	87	97
HC 90 T4 11kW (A6:6) (34°)	Inlet	66	75	80	87	88	89	91	85	95
HC 90 T4 15kW (A6:6) (36°)	Inlet	66	75	80	86	88	89	90	85	95
HC 90 T4 15kW (A6:6) (38°)	Inlet	67	76	81	87	88	89	91	85	96
HC 90 T4 15kW (A6:6) (40°)	Inlet	68	76	81	88	89	90	91	85	96
HC 100 T4 5,5kW (A6:3) (20°)	Inlet	64	71	76	81	87	88	92	84	95
HC 100 T4 5,5kW (A6:3) (22°)	Inlet	64	71	76	81	87	88	92	84	95
HC 100 T4 5,5kW (A6:3) (24°)	Inlet	66	72	78	83	87	88	91	85	95
HC 100 T4 5,5kW (A6:3) (26°)	Inlet	66	72	78	83	87	88	91	84	94
HC 100 T4 7,5kW (A6:3) (28°)	Inlet	66	72	78	83	86	88	90	84	94
HC 100 T4 7,5kW (A6:3) (30°)	Inlet	66	72	78	84	86	87	89	83	94
HC 100 T4 7,5kW (A6:6) (20°)	Inlet	69	80	85	95	96	95	95	91	102

SOUND POWER Lw dB (A)

Model		63 Hz	125 Hz	250 Hz	500 Hz	1000 Hz	2000 Hz	4000 Hz	8000 Hz	Total
HC 100 T4 7,5kW (A6:6) (22°)	Inlet	69	80	85	95	95	95	95	91	102
HC 100 T4 11kW (A6:3) (32°)	Inlet	68	73	80	85	87	88	90	84	95
HC 100 T4 11kW (A6:3) (34°)	Inlet	69	75	81	87	89	90	90	85	96
HC 100 T4 11kW (A6:3) (36°)	Inlet	69	75	82	88	90	90	91	86	96
HC 100 T4 11kW (A6:6) (24°)	Inlet	70	80	85	94	95	95	95	91	102
HC 100 T4 11kW (A6:6) (26°)	Inlet	71	81	86	94	95	95	96	91	102
HC 100 T4 11kW (A6:6) (28°)	Inlet	73	81	87	95	95	95	96	92	103
HC 100 T4 15kW (A6:3) (38°)	Inlet	69	76	82	89	90	91	91	86	97
HC 100 T4 15kW (A6:3) (40°)	Inlet	69	77	82	90	91	92	92	87	98
HC 100 T4 15kW (A6:6) (30°)	Inlet	73	81	87	94	95	95	97	92	102
HC 100 T4 15kW (A6:6) (32°)	Inlet	72	80	86	92	94	94	95	90	101
HC 100 T4 18,5kW (A6:6) (34°)	Inlet	72	80	86	90	92	93	94	89	99
HC 100 T4 18,5kW (A6:6) (36°)	Inlet	71	79	85	89	92	92	94	88	99
HC 100 T4 22kW (A6:6) (38°)	Inlet	72	80	86	90	92	93	94	89	99
HC 100 T4 22kW (A6:6) (40°)	Inlet	73	81	86	91	93	94	95	89	101
HC 112 T4 5,5kW (A6:3) (20°)	Inlet	67	74	79	86	91	92	94	89	99
HC 112 T4 5,5kW (A6:3) (22°)	Inlet	69	76	81	87	92	93	95	90	99
HC 112 T4 7,5kW (A6:3) (24°)	Inlet	70	77	82	88	92	93	95	90	100
HC 112 T4 7,5kW (A6:3) (26°)	Inlet	71	77	83	89	92	93	96	90	100
HC 112 T4 11kW (A6:3) (28°)	Inlet	71	77	83	89	92	93	95	90	100
HC 112 T4 11kW (A6:3) (30°)	Inlet	71	77	83	89	92	92	95	90	99
HC 112 T4 11kW (A6:6) (20°)	Inlet	69	80	86	97	98	97	98	93	104
HC 112 T4 11kW (A6:6) (22°)	Inlet	70	80	86	96	98	97	98	93	104
HC 112 T4 15kW (A6:3) (32°)	Inlet	72	77	84	89	92	92	94	90	99
HC 112 T4 15kW (A6:3) (34°)	Inlet	73	77	85	90	92	92	94	90	99
HC 112 T4 15kW (A6:3) (36°)	Inlet	73	78	85	90	92	93	94	90	99
HC 112 T4 15kW (A6:6) (24°)	Inlet	71	80	86	95	97	96	97	92	103
HC 112 T4 15kW (A6:6) (26°)	Inlet	72	81	86	95	97	97	98	92	104
HC 112 T4 15kW (A6:6) (28°)	Inlet	74	82	87	95	97	97	98	92	104
HC 112 T4 18,5kW (A6:3) (38°)	Inlet	73	79	85	91	93	93	94	90	100
HC 112 T4 18,5kW (A6:6) (30°)	Inlet	75	82	87	94	96	97	98	91	103
HC 112 T4 22kW (A6:3) (40°)	Inlet	73	79	85	91	93	94	94	90	100
HC 112 T4 22kW (A6:6) (32°)	Inlet	74	81	86	92	95	96	97	90	102
HC 112 T4 22kW (A6:6) (34°)	Inlet	74	81	86	91	94	95	96	89	101
HC 112 T4 30kW (A6:6) (36°)	Inlet	75	82	87	91	94	95	96	89	102
HC 112 T4 30kW (A6:6) (38°)	Inlet	77	83	89	92	96	97	98	91	103
HC 112 T4 30kW (A6:6) (40°)	Inlet	78	85	90	94	97	98	99	92	104
HC 125 T4 11kW (A7:4) (20°)	Inlet	72	85	90	98	102	102	104	101	109
HC 125 T4 11kW (A7:4) (22°)	Inlet	75	86	91	98	102	103	105	101	109

SOUND POWER Lw dB (A)										
Model		63 Hz	125 Hz	250 Hz	500 Hz	1000 Hz	2000 Hz	4000 Hz	8000 Hz	Total
HC 125 T4 15kW (A7:4) (24°)	Inlet	75	85	90	96	100	101	103	98	107
HC 125 T4 15kW (A7:4) (26°)	Inlet	76	84	89	94	98	99	101	95	106
HC 125 T4 15kW (A7:8) (20°)	Inlet	77	85	92	101	107	110	109	104	115
HC 125 T4 18,5kW (A7:4) (28°)	Inlet	75	82	87	92	96	98	99	93	104
HC 125 T4 18,5kW (A7:4) (30°)	Inlet	74	81	86	90	94	96	97	90	102
HC 125 T4 18,5kW (A7:8) (22°)	Inlet	77	85	91	99	106	109	108	103	113
HC 125 T4 22kW (A7:4) (32°)	Inlet	74	81	86	90	93	95	96	89	101
HC 125 T4 22kW (A7:8) (24°)	Inlet	77	84	91	98	105	107	107	101	112
HC 125 T4 30kW (A7:4) (34°)	Inlet	73	80	85	90	93	95	96	88	101
HC 125 T4 30kW (A7:4) (36°)	Inlet	74	81	86	90	93	95	96	88	101
HC 125 T4 30kW (A7:8) (26°)	Inlet	77	84	90	97	103	106	106	99	111
HC 125 T4 30kW (A7:8) (28°)	Inlet	77	83	90	96	102	105	105	98	110
HC 125 T4 37kW (A7:4) (38°)	Inlet	75	82	87	91	94	96	96	89	102
HC 125 T4 37kW (A7:4) (40°)	Inlet	75	82	87	92	94	96	96	90	102
HC 125 T4 37kW (A7:8) (30°)	Inlet	77	83	89	95	100	103	103	96	108
HC 125 T4 37kW (A7:8) (32°)	Inlet	77	83	89	94	99	101	102	94	106
HC 125 T4 45kW (A7:8) (34°)	Inlet	77	83	89	94	98	100	100	92	105
HC 125 T4 45kW (A7:8) (36°)	Inlet	77	84	89	94	97	99	99	91	105

SOUND / 6 poles

SOUND POWER Lw dB (A)										
Model		63 Hz	125 Hz	250 Hz	500 Hz	1000 Hz	2000 Hz	4000 Hz	8000 Hz	Total
HC 40 M6 0,04kW (A0:6) (35°)	Inlet	35	42	48	51	54	56	57	50	62
HC 40 T6 0,12kW (A0:6) (35°)	Inlet	35	42	48	51	54	56	57	50	62
HC 45 M6 0,13kW (A0:6) (45°)	Inlet	41	48	53	57	60	61	61	54	67
HC 45 T6 0,13kW (A0:6) (45°)	Inlet	41	48	53	57	60	61	61	54	67
HC 50 M6 0,13kW (A0:6) (45°)	Inlet	42	49	55	59	62	62	62	56	69
HC 50 T6 0,13kW (A0:6) (45°)	Inlet	42	49	55	59	62	62	62	56	69
HC 56 M6 0,25kW (A2:6) (20°)	Inlet	37	45	54	64	65	66	67	62	72
HC 56 M6 0,25kW (A2:6) (25°)	Inlet	40	48	56	64	66	66	67	62	73
HC 56 M6 0,25kW (A2:6) (27,5°)	Inlet	42	49	56	62	64	65	66	61	71
HC 56 M6 0,25kW (A2:6) (30°)	Inlet	42	49	55	61	64	65	66	60	71
HC 56 M6 0,25kW (A2:6) (32,5°)	Inlet	43	50	55	61	63	65	66	61	71
HC 56 M6 0,25kW (A2:6) (35°)	Inlet	43	50	55	61	63	65	66	61	71
HC 56 M6 0,25kW (A2:6) (37,5°)	Inlet	44	51	56	62	64	66	66	60	71
HC 56 M6 0,25kW (A5:6) (30°)	Inlet	47	54	59	68	69	69	71	63	76
HC 56 M6 0,25kW (A5:6) (32,5°)	Inlet	46	53	58	67	66	67	70	62	74
HC 56 M6 0,25kW (A5:6) (35°)	Inlet	44	51	56	65	64	66	69	60	73

SOUND POWER Lw dB (A)

Model		63 Hz	125 Hz	250 Hz	500 Hz	1000 Hz	2000 Hz	4000 Hz	8000 Hz	Total
HC 56 M6 0,37kW (A2:6) (40°)	Inlet	45	52	57	62	64	66	67	60	72
HC 56 M6 0,37kW (A2:6) (42,5°)	Inlet	45	51	57	62	65	66	67	60	72
HC 56 M6 0,37kW (A2:6) (45°)	Inlet	47	50	59	63	66	67	67	61	72
HC 56 M6 0,37kW (A5:6) (37,5°)	Inlet	46	53	58	66	65	67	69	61	73
HC 56 M6 0,37kW (A5:6) (40°)	Inlet	47	54	59	67	66	67	70	61	74
HC 56 T6 0,25kW (A5:6) (30°)	Inlet	47	54	59	68	69	69	71	63	76
HC 56 T6 0,25kW (A5:6) (32,5°)	Inlet	46	53	58	67	66	67	70	62	74
HC 56 T6 0,25kW (A5:6) (35°)	Inlet	44	51	56	65	64	66	69	60	73
HC 56 T6 0,37kW (A5:6) (37,5°)	Inlet	46	53	58	66	65	67	69	61	73
HC 56 T6 0,37kW (A5:6) (40°)	Inlet	47	54	59	67	66	67	70	61	74
HC 56 T6 0,55kW (A2:6) (20°)	Inlet	37	45	54	64	65	66	67	62	72
HC 56 T6 0,55kW (A2:6) (25°)	Inlet	40	48	56	64	66	66	67	62	73
HC 56 T6 0,55kW (A2:6) (27,5°)	Inlet	42	49	56	62	64	65	66	61	71
HC 56 T6 0,55kW (A2:6) (30°)	Inlet	42	49	55	61	64	65	66	60	71
HC 56 T6 0,55kW (A2:6) (32,5°)	Inlet	43	50	55	61	63	65	66	61	71
HC 56 T6 0,55kW (A2:6) (35°)	Inlet	43	50	55	61	63	65	66	61	71
HC 56 T6 0,55kW (A2:6) (37,5°)	Inlet	44	51	56	62	64	66	66	60	71
HC 56 T6 0,55kW (A2:6) (40°)	Inlet	45	52	57	62	64	66	67	60	72
HC 56 T6 0,55kW (A2:6) (42,5°)	Inlet	45	51	57	62	65	66	67	60	72
HC 56 T6 0,55kW (A2:6) (45°)	Inlet	47	50	59	63	66	67	67	61	72
HC 56 T6 0,55kW (A2:9) (20°)	Inlet	44	49	57	64	67	67	67	60	73
HC 56 T6 0,55kW (A2:9) (25°)	Inlet	44	49	57	64	67	67	68	61	73
HC 56 T6 0,55kW (A2:9) (27,5°)	Inlet	44	49	58	64	67	67	68	63	74
HC 56 T6 0,55kW (A2:9) (30°)	Inlet	44	50	58	64	67	68	69	63	74
HC 56 T6 0,55kW (A2:9) (32,5°)	Inlet	44	49	58	64	67	68	69	63	74
HC 56 T6 0,55kW (A2:9) (35°)	Inlet	43	49	58	64	67	68	69	63	74
HC 56 T6 0,55kW (A2:9) (37,5°)	Inlet	43	50	59	64	67	67	69	63	74
HC 56 T6 0,55kW (A2:9) (40°)	Inlet	44	50	59	63	67	67	68	63	73
HC 56 T6 0,55kW (A2:9) (42,5°)	Inlet	44	50	60	63	67	67	68	63	74
HC 56 T6 0,55kW (A2:9) (45°)	Inlet	44	51	61	64	67	68	68	63	74
HC 63 M6 0,37kW (A5:6) (35°)	Inlet	50	58	63	66	67	67	70	64	75
HC 63 M6 0,55kW (A2:9) (20°)	Inlet	48	50	61	67	69	68	70	65	75
HC 63 M6 0,55kW (A2:9) (25°)	Inlet	48	51	60	67	69	69	70	65	75
HC 63 M6 0,55kW (A2:9) (27,5°)	Inlet	48	53	60	67	69	70	71	66	76
HC 63 M6 0,55kW (A2:9) (30°)	Inlet	48	53	60	67	69	70	71	66	76
HC 63 M6 0,55kW (A2:9) (32,5°)	Inlet	48	53	61	67	69	70	71	66	76
HC 63 M6 0,55kW (A2:9) (35°)	Inlet	47	54	61	67	69	71	72	66	77
HC 63 M6 0,55kW (A2:9) (37,5°)	Inlet	48	54	60	67	69	71	71	66	76
HC 63 M6 0,55kW (A5:6) (37,5°)	Inlet	50	58	63	67	68	68	71	64	75

SOUND POWER Lw dB (A)

Model		63 Hz	125 Hz	250 Hz	500 Hz	1000 Hz	2000 Hz	4000 Hz	8000 Hz	Total
HC 63 M6 0,55kW (A5:6) (40°)	Inlet	51	58	63	68	69	69	71	64	76
HC 63 T6 0,37kW (A5:6) (35°)	Inlet	50	58	63	66	67	67	70	64	75
HC 63 T6 0,55KW (A2:6) (20°)	Inlet	39	42	54	64	64	64	66	60	71
HC 63 T6 0,55KW (A2:6) (25°)	Inlet	43	48	58	66	67	68	69	64	74
HC 63 T6 0,55KW (A2:6) (27,5°)	Inlet	44	50	57	65	66	68	68	64	74
HC 63 T6 0,55KW (A2:6) (30°)	Inlet	44	51	57	64	66	68	68	64	73
HC 63 T6 0,55KW (A2:6) (32,5°)	Inlet	44	51	56	64	65	68	68	63	73
HC 63 T6 0,55KW (A2:6) (35°)	Inlet	44	51	56	63	65	67	68	62	73
HC 63 T6 0,55KW (A2:6) (37,5°)	Inlet	45	52	57	63	66	68	68	62	73
HC 63 T6 0,55KW (A2:6) (40°)	Inlet	46	52	58	64	66	68	68	62	73
HC 63 T6 0,55KW (A2:6) (42,5°)	Inlet	47	52	59	64	67	68	68	63	74
HC 63 T6 0,55KW (A2:6) (45°)	Inlet	49	53	61	65	68	69	69	63	75
HC 63 T6 0,55kW (A2:9) (20°)	Inlet	48	50	61	67	69	68	70	65	75
HC 63 T6 0,55kW (A2:9) (25°)	Inlet	48	51	60	67	69	69	70	65	75
HC 63 T6 0,55kW (A2:9) (27,5°)	Inlet	48	53	60	67	69	70	71	66	76
HC 63 T6 0,55kW (A2:9) (30°)	Inlet	48	53	60	67	69	70	71	66	76
HC 63 T6 0,55kW (A2:9) (32,5°)	Inlet	48	53	61	67	69	70	71	66	76
HC 63 T6 0,55kW (A2:9) (35°)	Inlet	47	54	61	67	69	71	72	66	77
HC 63 T6 0,55kW (A2:9) (37,5°)	Inlet	48	54	60	67	69	71	71	66	76
HC 63 T6 0,55kW (A5:6) (37,5°)	Inlet	50	58	63	67	68	68	71	64	75
HC 63 T6 0,55kW (A5:6) (40°)	Inlet	51	58	63	68	69	69	71	64	76
HC 63 T6 0,75kW (A2:9) (40°)	Inlet	48	54	60	66	69	70	71	66	76
HC 63 T6 0,75kW (A2:9) (42,5°)	Inlet	47	54	59	66	69	70	71	66	76
HC 63 T6 0,75kW (A2:9) (45°)	Inlet	47	54	59	66	69	70	71	66	76
HC 71 M6 0,55kW (A2:6) (20°)	Inlet	45	51	62	70	73	72	75	68	79
HC 71 M6 0,55kW (A2:6) (25°)	Inlet	47	53	62	69	72	72	74	68	78
HC 71 M6 0,55kW (A2:6) (27,5°)	Inlet	48	54	61	68	70	72	73	68	78
HC 71 M6 0,55kW (A2:6) (30°)	Inlet	48	55	61	68	70	72	72	67	77
HC 71 M6 0,55kW (A2:6) (32,5°)	Inlet	48	55	60	67	69	71	71	66	76
HC 71 M6 0,55kW (A2:6) (35°)	Inlet	47	54	59	66	68	70	71	64	75
HC 71 M6 0,55kW (A2:6) (37,5°)	Inlet	49	56	61	66	69	71	71	65	76
HC 71 M6 0,55kW (A2:9) (20°)	Inlet	51	57	66	73	76	75	77	70	82
HC 71 M6 0,55kW (A2:9) (25°)	Inlet	51	57	64	72	74	74	76	69	81
HC 71 M6 0,55kW (A2:9) (27,5°)	Inlet	51	57	63	70	73	73	75	69	80
HC 71 M6 0,55kW (A2:9) (30°)	Inlet	51	57	63	70	72	73	74	69	79
HC 71 T6 0,55kW (A2:6) (20°)	Inlet	45	51	62	70	73	72	75	68	79
HC 71 T6 0,55kW (A2:6) (25°)	Inlet	47	53	62	69	72	72	74	68	78
HC 71 T6 0,55kW (A2:6) (27,5°)	Inlet	48	54	61	68	70	72	73	68	78
HC 71 T6 0,55kW (A2:6) (30°)	Inlet	48	55	61	68	70	72	72	67	77

SOUND POWER Lw dB (A)

Model		63 Hz	125 Hz	250 Hz	500 Hz	1000 Hz	2000 Hz	4000 Hz	8000 Hz	Total
HC 71 T6 0,55kW (A2:6) (32,5°)	Inlet	48	55	60	67	69	71	71	66	76
HC 71 T6 0,55kW (A2:6) (35°)	Inlet	47	54	59	66	68	70	71	64	75
HC 71 T6 0,55kW (A2:6) (37,5°)	Inlet	49	56	61	66	69	71	71	65	76
HC 71 T6 0,55kW (A2:9) (20°)	Inlet	51	57	66	73	76	75	77	70	82
HC 71 T6 0,55kW (A2:9) (25°)	Inlet	51	57	64	72	74	74	76	69	81
HC 71 T6 0,55kW (A2:9) (27,5°)	Inlet	51	57	63	70	73	73	75	69	80
HC 71 T6 0,55kW (A2:9) (30°)	Inlet	51	57	63	70	72	73	74	69	79
HC 71 T6 0,75kW (A2:6) (40°)	Inlet	50	57	62	67	70	71	71	65	77
HC 71 T6 0,75kW (A2:6) (42,5°)	Inlet	51	57	63	67	70	71	71	65	77
HC 71 T6 0,75kW (A2:6) (45°)	Inlet	52	56	64	68	71	71	71	65	77
HC 71 T6 0,75kW (A2:9) (32,5°)	Inlet	50	57	62	70	73	74	74	69	79
HC 71 T6 0,75kW (A2:9) (35°)	Inlet	50	57	62	70	73	74	74	68	79
HC 71 T6 0,75kW (A2:9) (37,5°)	Inlet	51	58	63	69	73	74	74	68	79
HC 71 T6 0,75kW (A5:6) (35°)	Inlet	54	61	66	67	71	73	74	63	79
HC 71 T6 0,75kW (A5:6) (37,5°)	Inlet	56	63	68	70	73	75	76	65	81
HC 71 T6 0,75kW (A5:6) (40°)	Inlet	59	65	71	73	76	77	78	68	83
HC 71 T6 1,1kW (A2:9) (40°)	Inlet	52	59	64	69	73	74	74	68	79
HC 71 T6 1,1kW (A2:9) (42,5°)	Inlet	52	59	64	69	73	74	74	68	79
HC 71 T6 1,1kW (A2:9) (45°)	Inlet	51	58	63	69	72	73	73	67	78
HC 80 T6 0,75kW (A2:6) (20°)	Inlet	45	52	62	70	74	73	75	70	80
HC 80 T6 0,75kW (A2:6) (25°)	Inlet	48	55	62	70	73	74	75	69	80
HC 80 T6 0,75kW (A2:6) (27,5°)	Inlet	50	57	62	69	73	74	75	69	80
HC 80 T6 0,75kW (A2:6) (30°)	Inlet	50	57	62	69	72	74	75	68	80
HC 80 T6 0,75kW (A2:6) (32,5°)	Inlet	51	58	63	69	72	74	75	68	79
HC 80 T6 0,75kW (A2:6) (35°)	Inlet	52	59	64	69	72	74	74	67	79
HC 80 T6 0,75kW (A2:9) (20°)	Inlet	50	62	68	80	82	80	82	74	87
HC 80 T6 0,75kW (A2:9) (25°)	Inlet	52	62	67	77	79	79	80	73	86
HC 80 T6 0,75kW (A2:9) (27,5°)	Inlet	54	61	66	75	78	78	79	73	84
HC 80 T6 0,75kW (A2:9) (30°)	Inlet	54	61	66	74	77	78	79	73	84
HC 80 T6 0,75kW (A5:6) (30°)	Inlet	55	62	67	74	78	77	81	74	85
HC 80 T6 1,1kW (A2:6) (37,5°)	Inlet	53	60	65	69	72	73	73	67	79
HC 80 T6 1,1kW (A2:6) (40°)	Inlet	52	60	65	69	72	73	72	66	78
HC 80 T6 1,1kW (A2:6) (42,5°)	Inlet	52	60	65	69	72	73	73	66	78
HC 80 T6 1,1kW (A2:9) (32,5°)	Inlet	54	61	66	73	77	78	78	72	83
HC 80 T6 1,1kW (A2:9) (35°)	Inlet	53	60	65	72	76	77	77	71	82
HC 80 T6 1,1kW (A5:6) (32,5°)	Inlet	54	61	66	72	76	75	79	71	83
HC 80 T6 1,1kW (A5:6) (35°)	Inlet	53	60	65	70	73	74	77	67	81
HC 80 T6 1,5KW (A2:6) (45°)	Inlet	53	60	66	70	73	73	73	66	79
HC 80 T6 1,5kW (A2:9) (37,5°)	Inlet	54	61	66	72	75	77	76	70	82

SOUND POWER Lw dB (A)

Model		63 Hz	125 Hz	250 Hz	500 Hz	1000 Hz	2000 Hz	4000 Hz	8000 Hz	Total
HC 80 T6 1,5kW (A2:9) (40°)	Inlet	55	62	67	71	75	77	76	70	82
HC 80 T6 1,5kW (A2:9) (42,5°)	Inlet	55	62	67	71	75	76	76	69	81
HC 80 T6 1,5kW (A5:6) (37,5°)	Inlet	55	62	67	71	74	75	77	68	81
HC 80 T6 1,5kW (A5:6) (40°)	Inlet	57	64	69	73	75	76	77	68	82
HC 80 T6 2,2kW (A2:9) (45°)	Inlet	54	62	68	71	74	75	75	69	81
HC 80 T6 2,2kW (A5:6) (42,5°)	Inlet	58	65	70	74	76	76	77	68	82
HC 90 T6 1,5kW (A6:3) (20°)	Inlet	50	54	62	65	70	71	74	68	78
HC 90 T6 1,5kW (A6:3) (22°)	Inlet	52	56	64	67	71	72	75	69	79
HC 90 T6 1,5kW (A6:3) (24°)	Inlet	53	57	65	69	73	74	76	70	80
HC 90 T6 1,5kW (A6:3) (26°)	Inlet	54	59	66	71	74	75	77	71	81
HC 90 T6 1,5kW (A6:3) (28°)	Inlet	55	60	67	73	75	76	78	72	82
HC 90 T6 1,5kW (A6:3) (30°)	Inlet	56	61	68	75	76	77	79	73	83
HC 90 T6 1,5kW (A6:3) (32°)	Inlet	56	62	69	76	77	78	79	73	84
HC 90 T6 1,5kW (A6:6) (20°)	Inlet	55	65	71	79	83	81	81	77	88
HC 90 T6 1,5kW (A6:6) (22°)	Inlet	56	66	72	79	83	81	82	77	88
HC 90 T6 1,5kW (A6:6) (24°)	Inlet	57	67	73	80	83	82	83	78	88
HC 90 T6 2,2kW (A6:3) (34°)	Inlet	56	62	69	77	77	78	79	74	85
HC 90 T6 2,2kW (A6:3) (36°)	Inlet	56	63	70	78	78	79	80	74	85
HC 90 T6 2,2kW (A6:3) (38°)	Inlet	57	64	71	79	79	80	81	75	87
HC 90 T6 2,2kW (A6:6) (26°)	Inlet	58	67	73	80	83	82	83	78	89
HC 90 T6 2,2kW (A6:6) (28°)	Inlet	59	68	73	81	83	82	84	79	89
HC 90 T6 2,2kW (A6:6) (30°)	Inlet	59	68	74	81	82	82	84	79	89
HC 90 T6 3kW (A6:3) (40°)	Inlet	57	65	72	80	80	82	82	76	87
HC 90 T6 3kW (A6:6) (32°)	Inlet	58	67	72	79	80	81	83	77	88
HC 90 T6 3kW (A6:6) (34°)	Inlet	57	66	71	77	79	80	81	76	86
HC 90 T6 3kW (A6:6) (36°)	Inlet	57	65	70	77	78	79	81	75	86
HC 90 T6 4kW (A6:6) (38°)	Inlet	57	66	71	78	79	80	81	76	86
HC 90 T6 4kW (A6:6) (40°)	Inlet	58	67	72	78	79	80	82	76	87
HC 100 T6 1,5kW (A6:3) (20°)	Inlet	55	62	67	72	77	79	82	75	85
HC 100 T6 1,5kW (A6:3) (22°)	Inlet	56	63	68	73	78	79	83	75	86
HC 100 T6 1,5kW (A6:3) (24°)	Inlet	56	63	68	74	78	79	82	75	86
HC 100 T6 1,5kW (A6:3) (26°)	Inlet	56	63	68	74	77	79	81	75	85
HC 100 T6 2,2kW (A6:3) (28°)	Inlet	56	63	68	74	77	78	80	74	84
HC 100 T6 2,2kW (A6:3) (30°)	Inlet	56	63	68	74	77	78	80	74	84
HC 100 T6 2,2kW (A6:3) (32°)	Inlet	58	64	70	76	78	79	80	75	85
HC 100 T6 2,2kW (A6:6) (20°)	Inlet	59	70	75	86	87	86	86	82	93
HC 100 T6 2,2kW (A6:6) (22°)	Inlet	60	70	75	85	86	85	86	81	92
HC 100 T6 2,2kW (A6:6) (24°)	Inlet	60	70	76	85	86	85	86	81	92
HC 100 T6 3kW (A6:3) (34°)	Inlet	60	65	72	78	79	80	81	76	86

SOUND POWER Lw dB (A)

Model		63 Hz	125 Hz	250 Hz	500 Hz	1000 Hz	2000 Hz	4000 Hz	8000 Hz	Total
HC 100 T6 3kW (A6:3) (36°)	Inlet	60	66	73	79	80	81	81	76	87
HC 100 T6 3kW (A6:6) (26°)	Inlet	62	71	77	85	86	86	86	82	92
HC 100 T6 3kW (A6:6) (28°)	Inlet	63	72	78	85	86	86	87	82	93
HC 100 T6 4kW (A6:3) (38°)	Inlet	60	67	73	79	81	82	82	77	88
HC 100 T6 4kW (A6:3) (40°)	Inlet	60	67	73	80	82	82	82	78	88
HC 100 T6 4kW (A6:6) (30°)	Inlet	64	72	78	85	86	86	87	82	93
HC 100 T6 4kW (A6:6) (32°)	Inlet	63	71	77	83	84	85	86	81	91
HC 100 T6 5,5kW (A6:6) (34°)	Inlet	62	70	76	81	83	83	85	80	90
HC 100 T6 5,5kW (A6:6) (36°)	Inlet	62	70	76	80	82	83	84	79	89
HC 100 T6 5,5kW (A6:6) (38°)	Inlet	63	71	76	81	83	84	85	79	90
HC 100 T6 7,5kW (A6:6) (40°)	Inlet	63	71	77	82	84	85	85	80	91
HC 112 T6 2,2kW (A6:3) (20°)	Inlet	58	65	70	77	82	83	85	80	89
HC 112 T6 2,2kW (A6:3) (22°)	Inlet	59	66	71	78	82	83	85	80	90
HC 112 T6 2,2kW (A6:3) (24°)	Inlet	60	67	72	79	83	84	86	81	90
HC 112 T6 2,2kW (A6:3) (26°)	Inlet	61	68	73	79	83	84	86	81	90
HC 112 T6 2,2kW (A6:6) (20°)	Inlet	60	71	76	88	89	87	89	84	95
HC 112 T6 3kW (A6:3) (28°)	Inlet	62	68	74	80	83	83	86	81	90
HC 112 T6 3kW (A6:3) (30°)	Inlet	62	67	74	80	82	83	85	80	90
HC 112 T6 3kW (A6:3) (32°)	Inlet	63	68	75	80	82	83	85	80	90
HC 112 T6 3kW (A6:6) (22°)	Inlet	61	71	77	87	88	87	88	83	94
HC 112 T6 3kW (A6:6) (24°)	Inlet	61	71	76	86	87	87	88	82	94
HC 112 T6 4kW (A6:3) (34°)	Inlet	63	68	75	80	83	83	85	80	90
HC 112 T6 4kW (A6:3) (36°)	Inlet	63	68	75	81	83	83	85	80	90
HC 112 T6 4kW (A6:6) (26°)	Inlet	63	72	77	86	87	87	88	82	94
HC 112 T6 4kW (A6:6) (28°)	Inlet	64	72	77	86	87	88	89	82	94
HC 112 T6 5,5kW (A6:3) (38°)	Inlet	64	69	76	81	83	84	85	81	90
HC 112 T6 5,5kW (A6:3) (40°)	Inlet	63	69	75	82	84	84	85	80	91
HC 112 T6 5,5kW (A6:6) (30°)	Inlet	65	72	77	85	87	88	88	82	93
HC 112 T6 5,5kW (A6:6) (32°)	Inlet	65	72	77	83	85	87	88	81	92
HC 112 T6 7,5kW (A6:6) (34°)	Inlet	65	72	77	81	84	86	87	80	92
HC 112 T6 7,5kW (A6:6) (36°)	Inlet	65	72	77	81	85	86	87	80	92
HC 112 T6 7,5kW (A6:6) (38°)	Inlet	67	74	79	83	86	87	88	81	93
HC 112 T6 11kW (A6:6) (40°)	Inlet	69	75	81	85	88	89	89	83	94
HC 125 T6 3kW (A7:4) (20°)	Inlet	62	76	81	88	92	92	94	91	99
HC 125 T6 3kW (A7:4) (22°)	Inlet	65	77	82	89	92	93	95	91	99
HC 125 T6 4kW (A7:4) (24°)	Inlet	66	75	80	87	90	91	93	89	97
HC 125 T6 4kW (A7:4) (26°)	Inlet	66	74	79	85	88	90	91	86	96
HC 125 T6 5,5kW (A7:4) (28°)	Inlet	66	73	78	83	87	88	89	84	94
HC 125 T6 5,5kW (A7:4) (30°)	Inlet	64	71	76	81	85	86	87	81	92

SOUND POWER Lw dB (A)										
Model		63 Hz	125 Hz	250 Hz	500 Hz	1000 Hz	2000 Hz	4000 Hz	8000 Hz	Total
HC 125 T6 5,5kW (A7:8) (20°)	Inlet	68	76	82	91	98	101	99	94	105
HC 125 T6 5,5kW (A7:8) (22°)	Inlet	68	76	82	90	96	99	99	93	104
HC 125 T6 7,5kW (A7:4) (32°)	Inlet	64	71	76	81	84	86	87	80	91
HC 125 T6 7,5kW (A7:4) (34°)	Inlet	64	71	76	80	84	85	86	79	91
HC 125 T6 7,5kW (A7:4) (36°)	Inlet	64	71	76	81	84	86	86	79	91
HC 125 T6 7,5kW (A7:8) (24°)	Inlet	68	75	81	89	95	97	97	91	103
HC 125 T6 7,5kW (A7:8) (26°)	Inlet	68	74	81	88	94	96	96	90	101
HC 125 T6 11kW (A7:4) (38°)	Inlet	65	72	77	82	85	87	87	80	92
HC 125 T6 11kW (A7:4) (40°)	Inlet	66	73	78	82	85	87	87	80	92
HC 125 T6 11kW (A7:8) (28°)	Inlet	68	74	80	87	92	95	95	89	100
HC 125 T6 11kW (A7:8) (30°)	Inlet	67	73	80	85	91	93	93	87	98
HC 125 T6 11kW (A7:8) (32°)	Inlet	68	73	80	85	89	92	92	85	97
HC 125 T6 11kW (A7:8) (34°)	Inlet	68	74	80	85	88	90	90	83	95
HC 125 T6 15kW (A7:8) (36°)	Inlet	68	75	80	85	88	90	89	82	95
HC 125 T6 15kW (A7:8) (38°)	Inlet	68	75	80	85	88	90	89	82	95
HC 125 T6 15kW (A7:8) (40°)	Inlet	68	75	80	84	87	89	88	82	94

SOUND / 4/6 poles

SOUND POWER Lw dB (A)										
Model		63 Hz	125 Hz	250 Hz	500 Hz	1000 Hz	2000 Hz	4000 Hz	8000 Hz	Total
HC 45 T4/T6 0,55/0,18kW (A0:6) (1410 RPM - 45°)	Inlet	50	57	63	67	69	70	70	64	76
HC 50 T4/T6 0,55/0,18kW (A0:6) (1410 RPM - 45°)	Inlet	51	59	64	68	71	72	72	65	78
HC 56 T4/T6 0,37/0,13kW (A5:6) (1380 RPM - 20°)	Inlet	52	60	67	74	80	75	77	69	84
HC 56 T4/T6 0,55/0,18kW (A2:6) (1410 RPM - 20°)	Inlet	46	54	64	73	75	75	76	72	82
HC 56 T4/T6 0,55/0,18kW (A2:6) (1410 RPM - 25°)	Inlet	50	57	65	73	75	76	77	72	82
HC 56 T4/T6 0,55/0,18kW (A2:9) (1410 RPM - 20°)	Inlet	54	58	67	73	76	76	77	69	82
HC 56 T4/T6 0,55/0,18kW (A5:6) (1410 RPM - 25°)	Inlet	54	62	67	75	79	76	78	70	84
HC 56 T4/T6 0,75/0,25kW (A2:6) (1420 RPM - 27,5°)	Inlet	51	58	65	72	74	75	76	70	81
HC 56 T4/T6 0,75/0,25kW (A2:6) (1420 RPM - 30°)	Inlet	52	59	65	71	73	74	76	70	80
HC 56 T4/T6 0,75/0,25kW (A2:6) (1420 RPM - 32,5°)	Inlet	53	60	65	71	73	75	75	70	80

SOUND POWER Lw dB (A)										
Model		63 Hz	125 Hz	250 Hz	500 Hz	1000 Hz	2000 Hz	4000 Hz	8000 Hz	Total
HC 56 T4/T6 0,75/0,25kW (A2:9) (1420 RPM - 25°)	Inlet	53	58	67	73	76	76	77	71	82
HC 56 T4/T6 0,75/0,25kW (A5:6) (1420 RPM - 30°)	Inlet	56	63	68	77	78	78	80	72	85
HC 56 T4/T6 0,75/0,25kW (A5:6) (1420 RPM - 32,5°)	Inlet	54	61	66	75	75	76	79	70	83
HC 56 T4/T6 1,1/0,37kW (A2:6) (1430 RPM - 35°)	Inlet	52	59	64	71	73	75	75	70	80
HC 56 T4/T6 1,1/0,37kW (A2:6) (1430 RPM - 37,5°)	Inlet	53	60	65	71	73	75	76	70	81
HC 56 T4/T6 1,1/0,37kW (A2:6) (1430 RPM - 40°)	Inlet	54	61	66	71	74	75	76	70	81
HC 56 T4/T6 1,1/0,37kW (A2:6) (1430 RPM - 42,5°)	Inlet	55	61	67	72	74	76	76	70	81
HC 56 T4/T6 1,1/0,37kW (A2:9) (1430 RPM - 27,5°)	Inlet	54	59	67	73	76	77	78	72	83
HC 56 T4/T6 1,1/0,37kW (A2:9) (1430 RPM - 30°)	Inlet	54	59	67	73	77	77	78	73	83
HC 56 T4/T6 1,1/0,37kW (A2:9) (1430 RPM - 32,5°)	Inlet	53	59	68	73	76	77	78	73	83
HC 56 T4/T6 1,1/0,37kW (A2:9) (1430 RPM - 35°)	Inlet	53	59	68	73	76	77	79	73	83
HC 56 T4/T6 1,1/0,37kW (A5:6) (1430 RPM - 35°)	Inlet	53	60	65	74	73	75	78	69	82
HC 56 T4/T6 1,1/0,37kW (A5:6) (1430 RPM - 37,5°)	Inlet	54	61	66	75	74	76	78	69	82
HC 56 T4/T6 1,5/0,5kW (A2:6) (1430 RPM - 45°)	Inlet	56	60	68	72	75	77	76	71	82
HC 56 T4/T6 1,5/0,5kW (A2:9) (1430 RPM - 37,5°)	Inlet	53	59	68	73	76	77	78	73	83
HC 56 T4/T6 1,5/0,5kW (A2:9) (1430 RPM - 40°)	Inlet	53	60	69	73	76	77	78	72	83
HC 56 T4/T6 1,5/0,5kW (A2:9) (1430 RPM - 42,5°)	Inlet	53	60	69	73	76	77	78	72	83
HC 56 T4/T6 1,5/0,5kW (A5:6) (1430 RPM - 40°)	Inlet	56	63	68	76	75	76	79	70	83
HC 63 T4/T6 0,55/0,18kW (A2:6) (1410 RPM - 20°)	Inlet	49	51	64	74	73	73	75	70	80
HC 63 T4/T6 0,75/0,25kW (A2:6) (1420 RPM - 25°)	Inlet	53	58	67	75	76	77	78	73	83
HC 63 T4/T6 0,75/0,25kW (A2:9) (1420 RPM - 20°)	Inlet	57	60	71	77	78	77	79	74	85
HC 63 T4/T6 0,75/0,25kW (A5:6) (1420 RPM - 25°)	Inlet	57	66	71	80	80	79	80	75	86
HC 63 T4/T6 1,1/0,37kW (A2:6) (1430 RPM - 27,5°)	Inlet	53	59	67	74	76	77	78	73	83

SOUND POWER Lw dB (A)										
Model		63 Hz	125 Hz	250 Hz	500 Hz	1000 Hz	2000 Hz	4000 Hz	8000 Hz	Total
HC 63 T4/T6 1,1/0,37kW (A2:6) (1430 RPM - 30°)	Inlet	53	60	66	74	75	77	78	73	83
HC 63 T4/T6 1,1/0,37kW (A2:6) (1430 RPM - 32,5°)	Inlet	53	61	66	73	75	77	77	72	82
HC 63 T4/T6 1,1/0,37kW (A2:9) (1430 RPM - 25°)	Inlet	57	61	70	76	78	78	80	74	85
HC 63 T4/T6 1,1/0,37kW (A5:6) (1430 RPM - 30°)	Inlet	60	68	74	80	80	79	82	77	87
HC 63 T4/T6 1,5/0,5kW (A2:6) (1430 RPM - 35°)	Inlet	53	60	65	72	74	77	77	72	82
HC 63 T4/T6 1,5/0,5kW (A2:6) (1430 RPM - 37,5°)	Inlet	54	61	66	73	75	77	77	72	82
HC 63 T4/T6 1,5/0,5kW (A2:6) (1430 RPM - 40°)	Inlet	55	62	67	73	76	77	77	72	83
HC 63 T4/T6 1,5/0,5kW (A2:9) (1430 RPM - 27,5°)	Inlet	58	62	70	76	78	79	80	75	85
HC 63 T4/T6 1,5/0,5kW (A2:9) (1430 RPM - 30°)	Inlet	58	63	70	76	78	80	81	75	86
HC 63 T4/T6 1,5/0,5kW (A2:9) (1430 RPM - 32,5°)	Inlet	57	63	70	77	79	80	81	75	86
HC 63 T4/T6 1,5/0,5kW (A5:6) (1430 RPM - 32,5°)	Inlet	59	68	73	77	78	77	80	75	85
HC 63 T4/T6 1,5/0,5kW (A5:6) (1430 RPM - 35°)	Inlet	59	67	72	75	76	76	79	73	83
HC 63 T4/T6 2,2/0,6kW (A2:6) (1430 RPM - 42,5°)	Inlet	56	62	68	74	76	78	78	72	83
HC 63 T4/T6 2,2/0,6kW (A2:6) (1430 RPM - 45°)	Inlet	58	62	70	74	78	78	78	72	84
HC 63 T4/T6 2,2/0,6kW (A2:9) (1430 RPM - 35°)	Inlet	57	63	70	77	79	80	81	76	86
HC 63 T4/T6 2,2/0,6kW (A2:9) (1430 RPM - 37,5°)	Inlet	57	63	70	76	79	80	81	76	86
HC 63 T4/T6 2,2/0,6kW (A2:9) (1430 RPM - 40°)	Inlet	57	63	69	76	79	80	80	76	86
HC 63 T4/T6 2,2/0,6kW (A2:9) (1430 RPM - 42,5°)	Inlet	57	64	69	76	79	80	81	76	86
HC 63 T4/T6 2,2/0,6kW (A5:6) (1430 RPM - 37,5°)	Inlet	59	67	72	76	77	77	79	73	84
HC 63 T4/T6 2,2/0,6kW (A5:6) (1430 RPM - 40°)	Inlet	60	67	72	77	78	78	80	73	85
HC 63 T4/T6 3/0,9kW (A2:9) (1440 RPM - 45°)	Inlet	57	64	69	76	78	80	81	75	86
HC 71 T4/T6 0,75/0,25kW (A2:6) (1420 RPM - 20°)	Inlet	55	61	72	79	83	82	84	78	89
HC 71 T4/T6 0,75/0,25kW (A5:6) (1420 RPM - 20°)	Inlet	55	66	71	86	85	82	84	76	91

SOUND POWER Lw dB (A)										
Model		63 Hz	125 Hz	250 Hz	500 Hz	1000 Hz	2000 Hz	4000 Hz	8000 Hz	Total
HC 71 T4/T6 1,1/0,37kW (A2:6) (1430 RPM - 25°)	Inlet	57	63	71	79	81	82	83	77	88
HC 71 T4/T6 1,1/0,37kW (A2:9) (1430 RPM - 20°)	Inlet	60	66	75	83	85	85	87	79	91
HC 71 T4/T6 1,1/0,37kW (A5:6) (1430 RPM - 25°)	Inlet	59	67	72	84	84	82	84	75	90
HC 71 T4/T6 1,5/0,5kW (A2:6) (1430 RPM - 27,5°)	Inlet	57	64	70	78	80	81	82	77	87
HC 71 T4/T6 1,5/0,5kW (A2:6) (1430 RPM - 30°)	Inlet	58	64	70	78	79	81	82	77	87
HC 71 T4/T6 1,5/0,5kW (A2:6) (1430 RPM - 32,5°)	Inlet	57	64	69	76	78	80	81	75	86
HC 71 T4/T6 1,5/0,5kW (A2:9) (1430 RPM - 25°)	Inlet	60	67	74	81	83	84	85	79	90
HC 71 T4/T6 1,5/0,5kW (A5:6) (1430 RPM - 30°)	Inlet	61	68	73	82	82	83	84	73	89
HC 71 T4/T6 2,2/0,6kW (A2:6) (1430 RPM - 35°)	Inlet	57	64	69	75	77	79	80	74	85
HC 71 T4/T6 2,2/0,6kW (A2:6) (1430 RPM - 37,5°)	Inlet	58	65	70	76	78	80	80	74	85
HC 71 T4/T6 2,2/0,6kW (A2:6) (1430 RPM - 40°)	Inlet	59	66	71	77	80	81	80	74	86
HC 71 T4/T6 2,2/0,6kW (A2:9) (1430 RPM - 27,5°)	Inlet	60	67	73	80	82	83	84	78	89
HC 71 T4/T6 2,2/0,6kW (A2:9) (1430 RPM - 30°)	Inlet	60	67	72	79	82	83	84	78	89
HC 71 T4/T6 2,2/0,6kW (A2:9) (1430 RPM - 32,5°)	Inlet	60	67	72	79	82	83	83	78	89
HC 71 T4/T6 2,2/0,6kW (A5:6) (1430 RPM - 32,5°)	Inlet	62	69	74	79	81	83	84	73	88
HC 71 T4/T6 2,2/0,6kW (A5:6) (1430 RPM - 35°)	Inlet	62	69	74	76	80	82	83	72	87
HC 71 T4/T6 3/0,9kW (A2:6) (1440 RPM - 42,5°)	Inlet	60	66	72	77	80	81	80	74	86
HC 71 T4/T6 3/0,9kW (A2:6) (1440 RPM - 45°)	Inlet	62	66	74	77	80	81	81	74	86
HC 71 T4/T6 3/0,9kW (A2:9) (1440 RPM - 35°)	Inlet	60	67	72	79	82	83	83	78	89
HC 71 T4/T6 3/0,9kW (A2:9) (1440 RPM - 37,5°)	Inlet	61	68	73	79	82	83	83	78	89
HC 71 T4/T6 3/0,9kW (A5:6) (1440 RPM - 37,5°)	Inlet	65	71	77	79	82	84	85	74	89
HC 71 T4/T6 3/0,9kW (A5:6) (1440 RPM - 40°)	Inlet	67	73	79	81	84	85	86	76	91
HC 80 T4/T6 1,1/0,37kW (A2:6) (1430 RPM - 20°)	Inlet	54	61	71	79	83	83	84	79	89

SOUND POWER Lw dB (A)										
Model		63 Hz	125 Hz	250 Hz	500 Hz	1000 Hz	2000 Hz	4000 Hz	8000 Hz	Total
HC 80 T4/T6 1,5/0,5kW (A2:6) (1430 RPM - 25°)	Inlet	57	64	72	79	83	83	84	79	89
HC 80 T4/T6 1,5/0,5kW (A2:9) (1430 RPM - 20°)	Inlet	60	72	77	89	91	89	92	84	97
HC 80 T4/T6 2,2/0,6kW (A2:6) (1430 RPM - 27,5°)	Inlet	60	67	72	79	82	84	84	78	89
HC 80 T4/T6 2,2/0,6kW (A2:6) (1430 RPM - 30°)	Inlet	60	67	72	79	82	84	84	78	89
HC 80 T4/T6 2,2/0,6kW (A2:6) (1430 RPM - 32,5°)	Inlet	61	68	73	79	82	84	84	77	89
HC 80 T4/T6 2,2/0,6kW (A2:9) (1430 RPM - 25°)	Inlet	62	71	76	86	89	88	90	83	95
HC 80 T4/T6 3/0,9kW (A2:6) (1440 RPM - 35°)	Inlet	62	69	74	78	81	84	84	77	89
HC 80 T4/T6 3/0,9kW (A2:6) (1440 RPM - 37,5°)	Inlet	62	69	74	78	81	83	83	76	88
HC 80 T4/T6 3/0,9kW (A2:9) (1440 RPM - 27,5°)	Inlet	63	71	76	85	88	88	89	82	94
HC 80 T4/T6 3/0,9kW (A2:9) (1440 RPM - 30°)	Inlet	63	70	75	84	87	88	88	82	93
HC 80 T4/T6 3/0,9kW (A5:6) (1440 RPM - 30°)	Inlet	64	71	76	83	87	86	90	83	94
HC 80 T4/T6 3/0,9kW (A5:6) (1440 RPM - 32,5°)	Inlet	63	70	75	81	85	84	88	80	91
HC 80 T4/T6 3/0,9kW (A5:6) (1440 RPM - 35°)	Inlet	62	69	74	79	82	82	86	76	89
HC 80 T4/T6 4/1,1kW (A2:6) (1430 RPM - 40°)	Inlet	61	69	74	78	81	82	82	75	88
HC 80 T4/T6 4/1,1kW (A2:6) (1430 RPM - 42,5°)	Inlet	62	69	75	78	81	82	82	75	88
HC 80 T4/T6 4/1,1kW (A2:9) (1430 RPM - 32,5°)	Inlet	63	70	75	83	86	87	87	81	93
HC 80 T4/T6 4/1,1kW (A2:9) (1430 RPM - 35°)	Inlet	62	69	74	81	85	87	86	80	92
HC 80 T4/T6 4/1,1kW (A5:6) (1430 RPM - 37,5°)	Inlet	64	71	76	80	83	83	86	76	90
HC 80 T4/T6 4/1,1kW (A5:6) (1430 RPM - 40°)	Inlet	66	73	78	82	84	84	86	76	91
HC 80 T4/T6 5,5/1,85kW (A2:6) (1450 RPM - 45°)	Inlet	62	69	75	79	82	82	82	75	88
HC 80 T4/T6 5,5/1,85kW (A2:9) (1450 RPM - 37,5°)	Inlet	63	70	75	81	85	87	86	80	91
HC 80 T4/T6 5,5/1,85kW (A2:9) (1450 RPM - 40°)	Inlet	64	71	76	81	84	86	85	79	91
HC 80 T4/T6 5,5/1,85kW (A2:9) (1450 RPM - 42,5°)	Inlet	64	71	76	81	84	86	85	79	91

SOUND POWER Lw dB (A)										
Model		63 Hz	125 Hz	250 Hz	500 Hz	1000 Hz	2000 Hz	4000 Hz	8000 Hz	Total
HC 90 T4/T6 3/0,9kW (A6:3) (1440 RPM - 20°)	Inlet	60	63	72	75	79	80	84	78	87
HC 90 T4/T6 3/0,9kW (A6:3) (1440 RPM - 22°)	Inlet	61	65	73	77	81	82	85	79	89
HC 90 T4/T6 4/1,1kW (A6:3) (1430 RPM - 24°)	Inlet	62	67	75	79	82	83	86	80	90
HC 90 T4/T6 4/1,1kW (A6:3) (1430 RPM - 26°)	Inlet	63	68	76	81	83	84	87	81	91
HC 90 T4/T6 4/1,1kW (A6:3) (1430 RPM - 28°)	Inlet	64	69	77	82	84	85	87	82	92
HC 90 T4/T6 5,5/1,85kW (A6:3) (1450 RPM - 30°)	Inlet	65	71	78	84	85	86	88	82	93
HC 90 T4/T6 5,5/1,85kW (A6:3) (1450 RPM - 32°)	Inlet	65	71	78	86	86	87	88	83	94
HC 90 T4/T6 5,5/1,85kW (A6:6) (1450 RPM - 20°)	Inlet	65	75	81	88	92	90	91	86	97
HC 90 T4/T6 5,5/1,85kW (A6:6) (1450 RPM - 22°)	Inlet	66	75	81	89	92	91	91	86	97
HC 90 T4/T6 7,5/2,2kW (A6:3) (1450 RPM - 34°)	Inlet	66	72	79	87	87	88	89	83	94
HC 90 T4/T6 7,5/2,2kW (A6:3) (1450 RPM - 36°)	Inlet	66	72	79	88	87	89	89	84	95
HC 90 T4/T6 7,5/2,2kW (A6:6) (1450 RPM - 24°)	Inlet	67	76	82	89	92	91	92	87	98
HC 90 T4/T6 7,5/2,2kW (A6:6) (1450 RPM - 26°)	Inlet	67	77	82	90	92	91	92	88	98
HC 90 T4/T6 7,5/2,2kW (A6:6) (1450 RPM - 28°)	Inlet	68	77	83	90	92	92	93	88	98
HC 90 T4/T6 11/3,6kW (A6:3) (1430 RPM - 38°)	Inlet	66	73	80	89	89	90	90	85	96
HC 90 T4/T6 11/3,6kW (A6:3) (1430 RPM - 40°)	Inlet	66	74	81	89	90	91	91	86	97
HC 90 T4/T6 11/3,6kW (A6:6) (1430 RPM - 30°)	Inlet	69	78	83	90	92	92	93	89	99
HC 90 T4/T6 11/3,6kW (A6:6) (1430 RPM - 32°)	Inlet	68	77	82	89	90	90	92	87	97
HC 90 T4/T6 11/3,6kW (A6:6) (1430 RPM - 34°)	Inlet	66	75	80	87	88	89	91	85	95
HC 90 T4/T6 15/4,4kW (A6:6) (1420 RPM - 36°)	Inlet	66	75	80	86	88	89	90	85	95
HC 90 T4/T6 15/4,4kW (A6:6) (1420 RPM - 38°)	Inlet	67	76	81	87	88	89	91	85	96
HC 90 T4/T6 15/4,4kW (A6:6) (1420 RPM - 40°)	Inlet	68	76	81	88	89	90	91	85	96
HC 100 T4/T6 5,5/1,85kW (A6:3) (1450 RPM - 20°)	Inlet	64	71	76	81	87	88	92	84	95

SOUND POWER Lw dB (A)										
Model		63 Hz	125 Hz	250 Hz	500 Hz	1000 Hz	2000 Hz	4000 Hz	8000 Hz	Total
HC 100 T4/T6 5,5/1,85kW (A6:3) (1450 RPM - 22°)	Inlet	64	71	76	81	87	88	92	84	95
HC 100 T4/T6 5,5/1,85kW (A6:3) (1450 RPM - 24°)	Inlet	66	72	78	83	87	88	91	85	95
HC 100 T4/T6 5,5/1,85kW (A6:3) (1450 RPM - 26°)	Inlet	66	72	78	83	87	88	91	84	94
HC 100 T4/T6 7,5/2,2kW (A6:3) (1450 RPM - 28°)	Inlet	66	72	78	83	86	88	90	84	94
HC 100 T4/T6 7,5/2,2kW (A6:3) (1450 RPM - 30°)	Inlet	66	72	78	84	86	87	89	83	94
HC 100 T4/T6 7,5/2,2kW (A6:6) (1450 RPM - 20°)	Inlet	69	80	85	95	96	95	95	91	102
HC 100 T4/T6 7,5/2,2kW (A6:6) (1450 RPM - 22°)	Inlet	69	80	85	95	95	95	95	91	102
HC 100 T4/T6 11/3,6kW (A6:3) (1430 RPM - 32°)	Inlet	68	73	80	85	87	88	90	84	95
HC 100 T4/T6 11/3,6kW (A6:3) (1430 RPM - 34°)	Inlet	69	75	81	87	89	90	90	85	96
HC 100 T4/T6 11/3,6kW (A6:3) (1430 RPM - 36°)	Inlet	69	75	82	88	90	90	91	86	96
HC 100 T4/T6 11/3,6kW (A6:6) (1430 RPM - 24°)	Inlet	70	80	85	94	95	95	95	91	102
HC 100 T4/T6 11/3,6kW (A6:6) (1430 RPM - 26°)	Inlet	71	81	86	94	95	95	96	91	102
HC 100 T4/T6 11/3,6kW (A6:6) (1430 RPM - 28°)	Inlet	73	81	87	95	95	95	96	92	103
HC 100 T4/T6 15/4,4kW (A6:3) (1420 RPM - 38°)	Inlet	69	76	82	89	90	91	91	86	97
HC 100 T4/T6 15/4,4kW (A6:3) (1420 RPM - 40°)	Inlet	69	77	82	90	91	92	92	87	98
HC 100 T4/T6 15/4,4kW (A6:6) (1420 RPM - 30°)	Inlet	73	81	87	94	95	95	97	92	102
HC 100 T4/T6 15/4,4kW (A6:6) (1420 RPM - 32°)	Inlet	72	80	86	92	94	94	95	90	101
HC 100 T4/T6 18,5/6kW (A6:6) (1420 RPM - 34°)	Inlet	72	80	86	90	92	93	94	89	99
HC 100 T4/T6 18,5/6kW (A6:6) (1420 RPM - 36°)	Inlet	71	79	85	89	92	92	94	88	99
HC 100 T4/T6 22/7,5kW (A6:6) (1420 RPM - 38°)	Inlet	72	80	86	90	92	93	94	89	99
HC 100 T4/T6 22/7,5kW (A6:6) (1420 RPM - 40°)	Inlet	73	81	86	91	93	94	95	89	101
HC 112 T4/T6 5,5/1,85kW (A6:3) (1450 RPM - 20°)	Inlet	67	74	79	86	91	92	94	89	99
HC 112 T4/T6 5,5/1,85kW (A6:3) (1450 RPM - 22°)	Inlet	69	76	81	87	92	93	95	90	99

SOUND POWER Lw dB (A)										
Model		63 Hz	125 Hz	250 Hz	500 Hz	1000 Hz	2000 Hz	4000 Hz	8000 Hz	Total
HC 112 T4/T6 7,5/2,2kW (A6:3) (1450 RPM - 24°)	Inlet	70	77	82	88	92	93	95	90	100
HC 112 T4/T6 7,5/2,2kW (A6:3) (1450 RPM - 26°)	Inlet	71	77	83	89	92	93	96	90	100
HC 112 T4/T6 11/3,6kW (A6:3) (1430 RPM - 28°)	Inlet	71	77	83	89	92	93	95	90	100
HC 112 T4/T6 11/3,6kW (A6:3) (1430 RPM - 30°)	Inlet	71	77	83	89	92	92	95	90	99
HC 112 T4/T6 11/3,6kW (A6:6) (1430 RPM - 20°)	Inlet	69	80	86	97	98	97	98	93	104
HC 112 T4/T6 11/3,6kW (A6:6) (1430 RPM - 22°)	Inlet	70	80	86	96	98	97	98	93	104
HC 112 T4/T6 15/4,4kW (A6:3) (1420 RPM - 32°)	Inlet	72	77	84	89	92	92	94	90	99
HC 112 T4/T6 15/4,4kW (A6:3) (1420 RPM - 34°)	Inlet	73	77	85	90	92	92	94	90	99
HC 112 T4/T6 15/4,4kW (A6:3) (1420 RPM - 36°)	Inlet	73	78	85	90	92	93	94	90	99
HC 112 T4/T6 15/4,4kW (A6:6) (1420 RPM - 24°)	Inlet	71	80	86	95	97	96	97	92	103
HC 112 T4/T6 15/4,4kW (A6:6) (1420 RPM - 26°)	Inlet	72	81	86	95	97	97	98	92	104
HC 112 T4/T6 15/4,4kW (A6:6) (1420 RPM - 28°)	Inlet	74	82	87	95	97	97	98	92	104
HC 112 T4/T6 18,5/6kW (A6:3) (1420 RPM - 38°)	Inlet	73	79	85	91	93	93	94	90	100
HC 112 T4/T6 18,5/6kW (A6:6) (1420 RPM - 30°)	Inlet	75	82	87	94	96	97	98	91	103
HC 112 T4/T6 22/7,5kW (A6:3) (1420 RPM - 40°)	Inlet	73	79	85	91	93	94	94	90	100
HC 112 T4/T6 22/7,5kW (A6:6) (1420 RPM - 32°)	Inlet	74	81	86	92	95	96	97	90	102
HC 112 T4/T6 22/7,5kW (A6:6) (1420 RPM - 34°)	Inlet	74	81	86	91	94	95	96	89	101
HC 125 T4/T6 11/3,6kW (A7:4) (1430 RPM - 20°)	Inlet	72	85	90	98	102	102	104	101	109
HC 125 T4/T6 11/3,6kW (A7:4) (1430 RPM - 22°)	Inlet	75	86	91	98	102	103	105	101	109
HC 125 T4/T6 15/4,4kW (A7:4) (1420 RPM - 24°)	Inlet	75	85	90	96	100	101	103	98	107
HC 125 T4/T6 15/4,4kW (A7:4) (1420 RPM - 26°)	Inlet	76	84	89	94	98	99	101	95	106
HC 125 T4/T6 15/4,4kW (A7:8) (1420 RPM - 20°)	Inlet	77	85	92	101	107	110	109	104	115
HC 125 T4/T6 18,5/6kW (A7:4) (1420 RPM - 28°)	Inlet	75	82	87	92	96	98	99	93	104

SOUND POWER Lw dB (A)										
Model		63 Hz	125 Hz	250 Hz	500 Hz	1000 Hz	2000 Hz	4000 Hz	8000 Hz	Total
HC 125 T4/T6 18,5/6kW (A7:4) (1420 RPM - 30°)	Inlet	74	81	86	90	94	96	97	90	102
HC 125 T4/T6 18,5/6kW (A7:8) (1420 RPM - 22°)	Inlet	77	85	91	99	106	109	108	103	113
HC 125 T4/T6 22/7,5kW (A7:4) (1420 RPM - 32°)	Inlet	74	81	86	90	93	95	96	89	101
HC 125 T4/T6 22/7,5kW (A7:8) (1420 RPM - 24°)	Inlet	77	84	91	98	105	107	107	101	112

SOUND / 4/8 poles

SOUND POWER Lw dB (A)										
Model		63 Hz	125 Hz	250 Hz	500 Hz	1000 Hz	2000 Hz	4000 Hz	8000 Hz	Total
HC 45 T4/T8 0,33/0,04kW (A0:6) (1420 RPM - 40°)	Inlet	39	57	69	74	76	70	63	58	79
HC 50 T4/T8 0,55/0,09kW (A0:6) (1420 RPM - 40°)	Inlet	51	59	64	68	71	72	72	65	78
HC 56 T4/T8 0,33/0,04kW (A5:6) (720 RPM - 20°)	Inlet	37	45	52	59	65	60	62	54	68
HC 56 T4/T8 0,33/0,04kW (A5:6) (1420 RPM - 20°)	Inlet	52	60	67	74	80	75	77	69	84
HC 56 T4/T8 0,55/0,09kW (A2:6) (720 RPM - 20°)	Inlet	30	38	48	57	59	59	60	56	66
HC 56 T4/T8 0,55/0,09kW (A2:6) (1420 RPM - 20°)	Inlet	46	54	64	73	75	75	76	72	82
HC 56 T4/T8 0,55/0,09kW (A2:6) (720 RPM - 25°)	Inlet	34	42	50	57	59	60	61	56	66
HC 56 T4/T8 0,55/0,09kW (A2:6) (1420 RPM - 25°)	Inlet	50	57	65	73	75	76	77	72	82
HC 56 T4/T8 0,55/0,09kW (A2:9) (720 RPM - 20°)	Inlet	38	42	51	58	60	60	61	53	66
HC 56 T4/T8 0,55/0,09kW (A2:9) (1420 RPM - 20°)	Inlet	54	58	67	73	76	76	77	69	82
HC 56 T4/T8 0,55/0,09kW (A5:6) (720 RPM - 25°)	Inlet	39	47	52	60	64	61	63	55	69
HC 56 T4/T8 0,55/0,09kW (A5:6) (1420 RPM - 25°)	Inlet	54	62	67	75	79	76	78	70	84
HC 56 T4/T8 0,75/0,12kW (A2:6) (720 RPM - 27,5°)	Inlet	35	42	49	56	58	59	60	55	65
HC 56 T4/T8 0,75/0,12kW (A2:6) (1420 RPM - 27,5°)	Inlet	51	58	65	72	74	75	76	70	81
HC 56 T4/T8 0,75/0,12kW (A2:6) (720 RPM - 30°)	Inlet	36	43	49	55	57	58	60	54	64
HC 56 T4/T8 0,75/0,12kW (A2:6) (1420 RPM - 30°)	Inlet	52	59	65	71	73	74	76	70	80

SOUND POWER Lw dB (A)

Model		63 Hz	125 Hz	250 Hz	500 Hz	1000 Hz	2000 Hz	4000 Hz	8000 Hz	Total
HC 56 T4/T8 0,75/0,12kW (A2:6) (720 RPM - 32,5°)	Inlet	37	44	49	55	57	59	60	54	64
HC 56 T4/T8 0,75/0,12kW (A2:6) (1420 RPM - 32,5°)	Inlet	53	60	65	71	73	75	75	70	80
HC 56 T4/T8 0,75/0,12kW (A2:9) (720 RPM - 25°)	Inlet	37	42	51	57	60	60	61	55	66
HC 56 T4/T8 0,75/0,12kW (A2:9) (1420 RPM - 25°)	Inlet	53	58	67	73	76	76	77	71	82
HC 56 T4/T8 0,75/0,12kW (A5:6) (720 RPM - 30°)	Inlet	41	48	53	62	63	62	65	57	69
HC 56 T4/T8 0,75/0,12kW (A5:6) (1420 RPM - 30°)	Inlet	54	61	66	75	75	76	79	70	83
HC 56 T4/T8 0,75/0,12kW (A5:6) (720 RPM - 32,5°)	Inlet	39	46	51	60	60	61	64	55	68
HC 56 T4/T8 0,75/0,12kW (A5:6) (1420 RPM - 32,5°)	Inlet	56	63	68	77	78	78	80	72	85
HC 56 T4/T8 1,1/0,18kW (A2:6) (720 RPM - 35°)	Inlet	36	43	48	55	57	59	60	54	64
HC 56 T4/T8 1,1/0,18kW (A2:6) (1420 RPM - 35°)	Inlet	52	59	64	71	73	75	75	70	80
HC 56 T4/T8 1,1/0,18kW (A2:6) (720 RPM - 37,5°)	Inlet	37	44	49	55	57	59	60	54	65
HC 56 T4/T8 1,1/0,18kW (A2:6) (1420 RPM - 37,5°)	Inlet	53	60	65	71	73	75	76	70	81
HC 56 T4/T8 1,1/0,18kW (A2:6) (720 RPM - 40°)	Inlet	38	45	50	56	58	60	60	54	65
HC 56 T4/T8 1,1/0,18kW (A2:6) (1420 RPM - 40°)	Inlet	54	61	66	71	74	75	76	70	81
HC 56 T4/T8 1,1/0,18kW (A2:6) (720 RPM - 42,5°)	Inlet	39	45	51	56	58	60	60	54	65
HC 56 T4/T8 1,1/0,18kW (A2:6) (1420 RPM - 42,5°)	Inlet	55	61	67	72	74	76	76	70	81
HC 56 T4/T8 1,1/0,18kW (A2:9) (720 RPM - 27,5°)	Inlet	38	43	51	57	61	61	62	56	67
HC 56 T4/T8 1,1/0,18kW (A2:9) (1420 RPM - 27,5°)	Inlet	54	59	67	73	76	77	78	72	83
HC 56 T4/T8 1,1/0,18kW (A2:9) (720 RPM - 30°)	Inlet	38	43	51	57	61	61	62	57	67
HC 56 T4/T8 1,1/0,18kW (A2:9) (1420 RPM - 30°)	Inlet	54	59	67	73	77	77	78	73	83
HC 56 T4/T8 1,1/0,18kW (A2:9) (720 RPM - 32,5°)	Inlet	37	43	52	57	61	61	63	57	67
HC 56 T4/T8 1,1/0,18kW (A2:9) (1420 RPM - 32,5°)	Inlet	53	59	68	73	76	77	78	73	83
HC 56 T4/T8 1,1/0,18kW (A2:9) (720 RPM - 35°)	Inlet	37	43	52	57	60	61	63	57	67

SOUND POWER Lw dB (A)										
Model		63 Hz	125 Hz	250 Hz	500 Hz	1000 Hz	2000 Hz	4000 Hz	8000 Hz	Total
HC 56 T4/T8 1,1/0,18kW (A2:9) (1420 RPM - 35°)	Inlet	53	59	68	73	76	77	79	73	83
HC 56 T4/T8 1,1/0,18kW (A5:6) (720 RPM - 35°)	Inlet	38	45	50	58	58	60	62	54	66
HC 56 T4/T8 1,1/0,18kW (A5:6) (1420 RPM - 35°)	Inlet	53	60	65	74	73	75	78	69	82
HC 56 T4/T8 1,1/0,18kW (A5:6) (720 RPM - 37,5°)	Inlet	39	46	51	59	59	60	63	54	67
HC 56 T4/T8 1,1/0,18kW (A5:6) (1420 RPM - 37,5°)	Inlet	54	61	66	75	74	76	78	69	82
HC 56 T4/T8 1,5/0,25kW (A2:6) (720 RPM - 45°)	Inlet	40	44	52	56	59	61	60	55	66
HC 56 T4/T8 1,5/0,25kW (A2:6) (1420 RPM - 45°)	Inlet	56	60	68	72	75	77	76	71	82
HC 56 T4/T8 1,5/0,25kW (A2:9) (720 RPM - 37,5°)	Inlet	37	43	52	57	60	61	62	57	67
HC 56 T4/T8 1,5/0,25kW (A2:9) (1420 RPM - 37,5°)	Inlet	53	59	68	73	76	77	78	73	83
HC 56 T4/T8 1,5/0,25kW (A2:9) (720 RPM - 40°)	Inlet	37	44	53	57	60	61	62	56	67
HC 56 T4/T8 1,5/0,25kW (A2:9) (1420 RPM - 40°)	Inlet	53	60	69	73	76	77	78	72	83
HC 56 T4/T8 1,5/0,25kW (A2:9) (720 RPM - 42,5°)	Inlet	37	44	53	57	60	61	62	56	67
HC 56 T4/T8 1,5/0,25kW (A2:9) (1420 RPM - 42,5°)	Inlet	53	60	69	73	76	77	78	72	83
HC 56 T4/T8 1,5/0,25kW (A5:6) (720 RPM - 40°)	Inlet	41	48	53	60	60	61	63	55	68
HC 56 T4/T8 1,5/0,25kW (A5:6) (1420 RPM - 40°)	Inlet	56	63	68	76	75	76	79	70	83
HC 63 T4/T8 0,55/0,09kW (A2:6) (720 RPM - 20°)	Inlet	33	36	48	58	58	57	59	54	64
HC 63 T4/T8 0,55/0,09kW (A2:6) (1420 RPM - 20°)	Inlet	49	51	64	74	73	73	75	70	80
HC 63 T4/T8 0,75/0,12kW (A2:6) (720 RPM - 25°)	Inlet	37	42	51	59	60	61	62	57	67
HC 63 T4/T8 0,75/0,12kW (A2:6) (1420 RPM - 25°)	Inlet	53	58	67	75	76	77	78	73	83
HC 63 T4/T8 0,75/0,12kW (A2:9) (720 RPM - 20°)	Inlet	41	44	55	61	63	62	63	58	69
HC 63 T4/T8 0,75/0,12kW (A2:9) (1420 RPM - 20°)	Inlet	57	60	71	77	78	77	79	74	85
HC 63 T4/T8 0,75/0,12kW (A5:6) (720 RPM - 25°)	Inlet	42	51	56	65	65	64	65	60	71
HC 63 T4/T8 0,75/0,12kW (A5:6) (1420 RPM - 25°)	Inlet	57	66	71	80	80	79	80	75	86

SOUND POWER Lw dB (A)										
Model		63 Hz	125 Hz	250 Hz	500 Hz	1000 Hz	2000 Hz	4000 Hz	8000 Hz	Total
HC 63 T4/T8 1,1/0,18kW (A2:6) (720 RPM - 27,5°)	Inlet	37	43	51	58	60	61	62	57	67
HC 63 T4/T8 1,1/0,18kW (A2:6) (1420 RPM - 27,5°)	Inlet	53	59	67	74	76	77	78	73	83
HC 63 T4/T8 1,1/0,18kW (A2:6) (720 RPM - 30°)	Inlet	37	44	51	58	60	61	62	57	67
HC 63 T4/T8 1,1/0,18kW (A2:6) (1420 RPM - 30°)	Inlet	53	60	66	74	75	77	78	73	83
HC 63 T4/T8 1,1/0,18kW (A2:6) (720 RPM - 32,5°)	Inlet	37	45	50	57	59	61	62	56	67
HC 63 T4/T8 1,1/0,18kW (A2:6) (1420 RPM - 32,5°)	Inlet	53	61	66	73	75	77	77	72	82
HC 63 T4/T8 1,1/0,18kW (A2:9) (720 RPM - 25°)	Inlet	41	45	54	60	62	62	64	58	69
HC 63 T4/T8 1,1/0,18kW (A2:9) (1420 RPM - 25°)	Inlet	57	61	70	76	78	78	80	74	85
HC 63 T4/T8 1,1/0,18kW (A2:9) (720 RPM - 27,5°)	Inlet	42	46	54	60	62	63	65	59	69
HC 63 T4/T8 1,1/0,18kW (A2:9) (1420 RPM - 27,5°)	Inlet	58	62	70	76	78	79	80	75	85
HC 63 T4/T8 1,1/0,18kW (A5:6) (720 RPM - 30°)	Inlet	45	53	59	65	65	64	67	62	72
HC 63 T4/T8 1,1/0,18kW (A5:6) (1420 RPM - 30°)	Inlet	60	68	74	80	80	79	82	77	87
HC 63 T4/T8 1,5/0,25kW (A2:6) (720 RPM - 35°)	Inlet	37	44	49	56	58	61	61	56	66
HC 63 T4/T8 1,5/0,25kW (A2:6) (1420 RPM - 35°)	Inlet	53	60	65	72	74	77	77	72	82
HC 63 T4/T8 1,5/0,25kW (A2:6) (720 RPM - 37,5°)	Inlet	38	45	50	57	59	61	61	56	67
HC 63 T4/T8 1,5/0,25kW (A2:6) (1420 RPM - 37,5°)	Inlet	54	61	66	73	75	77	77	72	82
HC 63 T4/T8 1,5/0,25kW (A2:6) (720 RPM - 40°)	Inlet	40	46	52	58	60	62	62	56	67
HC 63 T4/T8 1,5/0,25kW (A2:6) (1420 RPM - 40°)	Inlet	55	62	67	73	76	77	77	72	83
HC 63 T4/T8 1,5/0,25kW (A2:9) (720 RPM - 30°)	Inlet	42	47	54	61	62	64	65	60	70
HC 63 T4/T8 1,5/0,25kW (A2:9) (1420 RPM - 30°)	Inlet	58	63	70	76	78	80	81	75	86
HC 63 T4/T8 1,5/0,25kW (A2:9) (720 RPM - 32,5°)	Inlet	41	47	54	61	63	64	65	60	70
HC 63 T4/T8 1,5/0,25kW (A2:9) (1420 RPM - 32,5°)	Inlet	57	63	70	77	79	80	81	75	86
HC 63 T4/T8 1,5/0,25kW (A5:6) (720 RPM - 32,5°)	Inlet	44	52	58	62	63	62	65	60	70

SOUND POWER Lw dB (A)

Model		63 Hz	125 Hz	250 Hz	500 Hz	1000 Hz	2000 Hz	4000 Hz	8000 Hz	Total
HC 63 T4/T8 1,5/0,25kW (A5:6) (1420 RPM - 32,5°)	Inlet	59	68	73	77	78	77	80	75	85
HC 63 T4/T8 1,5/0,25kW (A5:6) (720 RPM - 35°)	Inlet	59	67	72	75	76	76	79	73	83
HC 63 T4/T8 1,5/0,25kW (A5:6) (1420 RPM - 35°)	Inlet	59	67	72	75	76	76	79	73	83
HC 63 T4/T8 2,2/0,37kW (A2:6) (720 RPM - 42,5°)	Inlet	40	46	52	58	60	62	62	56	67
HC 63 T4/T8 2,2/0,37kW (A2:6) (1420 RPM - 42,5°)	Inlet	56	62	68	74	76	78	78	72	83
HC 63 T4/T8 2,2/0,37kW (A2:6) (720 RPM - 45°)	Inlet	42	46	54	59	62	62	62	56	68
HC 63 T4/T8 2,2/0,37kW (A2:6) (1420 RPM - 45°)	Inlet	58	62	70	74	78	78	78	72	84
HC 63 T4/T8 2,2/0,37kW (A2:9) (720 RPM - 35°)	Inlet	41	47	54	61	63	64	65	60	70
HC 63 T4/T8 2,2/0,37kW (A2:9) (1420 RPM - 35°)	Inlet	57	63	70	77	79	80	81	76	86
HC 63 T4/T8 2,2/0,37kW (A2:9) (720 RPM - 37,5°)	Inlet	41	47	54	60	63	64	65	60	70
HC 63 T4/T8 2,2/0,37kW (A2:9) (1420 RPM - 37,5°)	Inlet	57	63	70	76	79	80	81	76	86
HC 63 T4/T8 2,2/0,37kW (A2:9) (720 RPM - 40°)	Inlet	41	48	53	60	63	64	65	60	70
HC 63 T4/T8 2,2/0,37kW (A2:9) (1420 RPM - 40°)	Inlet	57	63	69	76	79	80	80	76	86
HC 63 T4/T8 2,2/0,37kW (A2:9) (720 RPM - 42,5°)	Inlet	41	48	53	60	63	64	65	60	70
HC 63 T4/T8 2,2/0,37kW (A2:9) (1420 RPM - 42,5°)	Inlet	57	64	69	76	79	80	81	76	86
HC 63 T4/T8 2,2/0,37kW (A5:6) (720 RPM - 37,5°)	Inlet	44	52	57	61	62	62	64	58	69
HC 63 T4/T8 2,2/0,37kW (A5:6) (1420 RPM - 37,5°)	Inlet	59	67	72	76	77	77	79	73	84
HC 63 T4/T8 2,2/0,37kW (A5:6) (720 RPM - 40°)	Inlet	45	52	57	62	62	63	65	58	70
HC 63 T4/T8 2,2/0,37kW (A5:6) (1420 RPM - 40°)	Inlet	60	67	72	77	78	78	80	73	85
HC 63 T4/T8 3/0,55kW (A2:9) (720 RPM - 45°)	Inlet	41	48	53	60	63	64	65	59	70
HC 63 T4/T8 3/0,55kW (A2:9) (1420 RPM - 45°)	Inlet	57	64	69	76	78	80	81	75	86
HC 71 T4/T8 0,75/0,12kW (A2:6) (1420 RPM - 20°)	Inlet	55	61	72	79	83	82	84	78	89
HC 71 T4/T8 0,75/0,12kW (A5:6) (720 RPM - 20°)	Inlet	40	51	56	71	70	67	69	61	76

SOUND POWER Lw dB (A)

Model		63 Hz	125 Hz	250 Hz	500 Hz	1000 Hz	2000 Hz	4000 Hz	8000 Hz	Total
HC 71 T4/T8 0,75/0,12kW (A5:6) (1420 RPM - 20°)	Inlet	55	66	71	86	85	82	84	76	91
HC 71 T4/T8 1,1/0,18kW (A2:6) (1420 RPM - 25°)	Inlet	57	63	71	79	81	82	83	77	88
HC 71 T4/T8 1,1/0,18kW (A2:9) (720 RPM - 20°)	Inlet	44	51	60	67	69	69	71	64	76
HC 71 T4/T8 1,1/0,18kW (A2:9) (1420 RPM - 20°)	Inlet	60	66	75	83	85	85	87	79	91
HC 71 T4/T8 1,1/0,18kW (A5:6) (720 RPM - 25°)	Inlet	44	51	56	69	68	67	69	60	75
HC 71 T4/T8 1,1/0,18kW (A5:6) (1420 RPM - 25°)	Inlet	59	67	72	84	84	82	84	75	90
HC 71 T4/T8 1,5/0,25kW (A2:6) (720 RPM - 27,5°)	Inlet	42	48	54	62	64	65	66	61	71
HC 71 T4/T8 1,5/0,25kW (A2:6) (1420 RPM - 27,5°)	Inlet	57	64	70	78	80	81	82	77	87
HC 71 T4/T8 1,5/0,25kW (A2:6) (720 RPM - 30°)	Inlet	42	48	54	62	63	65	66	61	71
HC 71 T4/T8 1,5/0,25kW (A2:6) (1420 RPM - 30°)	Inlet	58	64	70	78	79	81	82	77	87
HC 71 T4/T8 1,5/0,25kW (A2:6) (720 RPM - 32,5°)	Inlet	41	48	53	60	62	64	65	59	70
HC 71 T4/T8 1,5/0,25kW (A2:6) (1420 RPM - 32,5°)	Inlet	57	64	69	76	78	80	81	75	86
HC 71 T4/T8 1,5/0,25kW (A2:9) (720 RPM - 25°)	Inlet	44	51	58	65	68	68	69	63	74
HC 71 T4/T8 1,5/0,25kW (A2:9) (1420 RPM - 25°)	Inlet	60	67	74	81	83	84	85	79	90
HC 71 T4/T8 1,5/0,25kW (A5:6) (720 RPM - 30°)	Inlet	46	53	58	67	67	68	69	58	74
HC 71 T4/T8 1,5/0,25kW (A5:6) (1420 RPM - 30°)	Inlet	61	68	73	82	82	83	84	73	89
HC 71 T4/T8 2,2/0,37kW (A2:6) (720 RPM - 35°)	Inlet	41	48	53	59	61	64	64	58	69
HC 71 T4/T8 2,2/0,37kW (A2:6) (1420 RPM - 35°)	Inlet	57	64	69	75	77	79	80	74	85
HC 71 T4/T8 2,2/0,37kW (A2:6) (720 RPM - 37,5°)	Inlet	42	49	54	60	63	64	64	58	70
HC 71 T4/T8 2,2/0,37kW (A2:6) (1420 RPM - 37,5°)	Inlet	58	65	70	76	78	80	80	74	85
HC 71 T4/T8 2,2/0,37kW (A2:6) (720 RPM - 40°)	Inlet	43	50	55	61	64	65	64	58	70
HC 71 T4/T8 2,2/0,37kW (A2:6) (1420 RPM - 40°)	Inlet	59	66	71	77	80	81	80	74	86
HC 71 T4/T8 2,2/0,37kW (A2:9) (720 RPM - 27,5°)	Inlet	44	51	57	64	66	67	68	63	73

SOUND POWER Lw dB (A)										
Model		63 Hz	125 Hz	250 Hz	500 Hz	1000 Hz	2000 Hz	4000 Hz	8000 Hz	Total
HC 71 T4/T8 2,2/0,37kW (A2:9) (1420 RPM - 27,5°)	Inlet	60	67	73	80	82	83	84	78	89
HC 71 T4/T8 2,2/0,37kW (A2:9) (720 RPM - 30°)	Inlet	44	51	56	63	66	67	68	62	73
HC 71 T4/T8 2,2/0,37kW (A2:9) (1420 RPM - 30°)	Inlet	60	67	72	79	82	83	84	78	89
HC 71 T4/T8 2,2/0,37kW (A2:9) (720 RPM - 32,5°)	Inlet	44	51	56	63	66	67	68	62	73
HC 71 T4/T8 2,2/0,37kW (A2:9) (1420 RPM - 32,5°)	Inlet	60	67	72	79	82	83	83	78	89
HC 71 T4/T8 2,2/0,37kW (A5:6) (720 RPM - 32,5°)	Inlet	46	53	58	64	66	68	68	58	73
HC 71 T4/T8 2,2/0,37kW (A5:6) (1420 RPM - 32,5°)	Inlet	62	69	74	79	81	83	84	73	88
HC 71 T4/T8 2,2/0,37kW (A5:6) (720 RPM - 35°)	Inlet	47	54	59	61	65	67	68	57	72
HC 71 T4/T8 2,2/0,37kW (A5:6) (1420 RPM - 35°)	Inlet	62	69	74	76	80	82	83	72	87
HC 71 T4/T8 3/0,55kW (A2:6) (720 RPM - 42,5°)	Inlet	44	50	56	61	64	65	64	58	70
HC 71 T4/T8 3/0,55kW (A2:6) (1420 RPM - 42,5°)	Inlet	60	66	72	77	80	81	80	74	86
HC 71 T4/T8 3/0,55kW (A2:6) (720 RPM - 45°)	Inlet	46	50	58	61	64	65	65	58	71
HC 71 T4/T8 3/0,55kW (A2:6) (1420 RPM - 45°)	Inlet	62	66	74	77	80	81	81	74	86
HC 71 T4/T8 3/0,55kW (A2:9) (720 RPM - 35°)	Inlet	44	51	56	63	66	68	67	62	73
HC 71 T4/T8 3/0,55kW (A2:9) (1420 RPM - 35°)	Inlet	60	67	72	79	82	83	83	78	89
HC 71 T4/T8 3/0,55kW (A2:9) (720 RPM - 37,5°)	Inlet	45	52	57	63	66	68	67	62	73
HC 71 T4/T8 3/0,55kW (A2:9) (1420 RPM - 37,5°)	Inlet	61	68	73	79	82	83	83	78	89
HC 71 T4/T8 3/0,55kW (A5:6) (720 RPM - 37,5°)	Inlet	50	56	62	64	67	69	70	59	74
HC 71 T4/T8 3/0,55kW (A5:6) (1420 RPM - 37,5°)	Inlet	65	71	77	79	82	84	85	74	89
HC 71 T4/T8 3/0,55kW (A5:6) (720 RPM - 40°)	Inlet	52	58	64	66	69	70	71	61	76
HC 71 T4/T8 3/0,55kW (A5:6) (1420 RPM - 40°)	Inlet	67	73	79	81	84	85	86	76	91
HC 80 T4/T8 1,1/0,18kW (A2:6) (720 RPM - 20°)	Inlet	38	45	55	64	67	67	68	64	73
HC 80 T4/T8 1,1/0,18kW (A2:6) (1420 RPM - 20°)	Inlet	54	61	71	79	83	83	84	79	89

SOUND POWER Lw dB (A)										
Model		63 Hz	125 Hz	250 Hz	500 Hz	1000 Hz	2000 Hz	4000 Hz	8000 Hz	Total
HC 80 T4/T8 1,5/0,25kW (A2:6) (720 RPM - 25°)	Inlet	42	49	56	63	67	67	69	63	73
HC 80 T4/T8 1,5/0,25kW (A2:6) (1420 RPM - 25°)	Inlet	57	64	72	79	83	83	84	79	89
HC 80 T4/T8 1,5/0,25kW (A2:9) (720 RPM - 20°)	Inlet	44	56	61	73	75	74	76	68	81
HC 80 T4/T8 1,5/0,25kW (A2:9) (1420 RPM - 20°)	Inlet	60	72	77	89	91	89	92	84	97
HC 80 T4/T8 2,2/0,37kW (A2:6) (720 RPM - 27,5°)	Inlet	44	51	56	63	66	68	68	62	73
HC 80 T4/T8 2,2/0,37kW (A2:6) (1420 RPM - 27,5°)	Inlet	60	67	72	79	82	84	84	78	89
HC 80 T4/T8 2,2/0,37kW (A2:6) (720 RPM - 30°)	Inlet	44	51	56	63	66	68	68	62	73
HC 80 T4/T8 2,2/0,37kW (A2:6) (1420 RPM - 30°)	Inlet	60	67	72	79	82	84	84	78	89
HC 80 T4/T8 2,2/0,37kW (A2:6) (720 RPM - 32,5°)	Inlet	45	52	57	63	66	68	68	62	73
HC 80 T4/T8 2,2/0,37kW (A2:6) (1420 RPM - 32,5°)	Inlet	61	68	73	79	82	84	84	77	89
HC 80 T4/T8 2,2/0,37kW (A2:9) (720 RPM - 25°)	Inlet	46	55	60	71	73	72	74	67	79
HC 80 T4/T8 2,2/0,37kW (A2:9) (1420 RPM - 25°)	Inlet	62	71	76	86	89	88	90	83	95
HC 80 T4/T8 3/0,55kW (A2:6) (720 RPM - 35°)	Inlet	46	53	58	63	66	68	68	61	73
HC 80 T4/T8 3/0,55kW (A2:6) (1420 RPM - 35°)	Inlet	62	69	74	78	81	84	84	77	89
HC 80 T4/T8 3/0,55kW (A2:6) (720 RPM - 37,5°)	Inlet	46	53	58	62	65	67	67	60	72
HC 80 T4/T8 3/0,55kW (A2:6) (1420 RPM - 37,5°)	Inlet	62	69	74	78	81	83	83	76	88
HC 80 T4/T8 3/0,55kW (A2:9) (720 RPM - 27,5°)	Inlet	48	55	60	69	72	72	73	67	78
HC 80 T4/T8 3/0,55kW (A2:9) (1420 RPM - 27,5°)	Inlet	63	71	76	85	88	88	89	82	94
HC 80 T4/T8 3/0,55kW (A2:9) (720 RPM - 30°)	Inlet	48	55	60	68	71	72	72	66	77
HC 80 T4/T8 3/0,55kW (A2:9) (1420 RPM - 30°)	Inlet	63	70	75	84	87	88	88	82	93
HC 80 T4/T8 3/0,55kW (A5:6) (720 RPM - 30°)	Inlet	49	56	61	68	72	71	74	68	79
HC 80 T4/T8 3/0,55kW (A5:6) (1420 RPM - 30°)	Inlet	64	71	76	83	87	86	90	83	94
HC 80 T4/T8 3/0,55kW (A5:6) (720 RPM - 32,5°)	Inlet	48	55	60	66	69	69	73	64	76

SOUND POWER Lw dB (A)

Model		63 Hz	125 Hz	250 Hz	500 Hz	1000 Hz	2000 Hz	4000 Hz	8000 Hz	Total
HC 80 T4/T8 3/0,55kW (A5:6) (1420 RPM - 32,5°)	Inlet	63	70	75	81	85	84	88	80	91
HC 80 T4/T8 3/0,55kW (A5:6) (720 RPM - 35°)	Inlet	47	54	59	64	67	67	71	61	74
HC 80 T4/T8 3/0,55kW (A5:6) (1420 RPM - 35°)	Inlet	62	69	74	79	82	82	86	76	89
HC 80 T4/T8 4/0,75kW (A2:6) (720 RPM - 40°)	Inlet	46	53	58	62	65	66	66	59	72
HC 80 T4/T8 4/0,75kW (A2:6) (1420 RPM - 40°)	Inlet	61	69	74	78	81	82	82	75	88
HC 80 T4/T8 4/0,75kW (A2:6) (720 RPM - 42,5°)	Inlet	46	53	59	62	65	66	66	59	72
HC 80 T4/T8 4/0,75kW (A2:6) (1420 RPM - 42,5°)	Inlet	62	69	75	78	81	82	82	75	88
HC 80 T4/T8 4/0,75kW (A2:9) (720 RPM - 32,5°)	Inlet	47	54	59	67	70	71	71	65	77
HC 80 T4/T8 4/0,75kW (A2:9) (1420 RPM - 32,5°)	Inlet	63	70	75	83	86	87	87	81	93
HC 80 T4/T8 4/0,75kW (A5:6) (720 RPM - 37,5°)	Inlet	49	56	61	65	68	68	71	61	75
HC 80 T4/T8 4/0,75kW (A5:6) (1420 RPM - 37,5°)	Inlet	64	71	76	80	83	83	86	76	90
HC 80 T4/T8 4/0,75kW (A5:6) (720 RPM - 40°)	Inlet	51	58	63	67	69	69	70	61	76
HC 80 T4/T8 4/0,75kW (A5:6) (1420 RPM - 40°)	Inlet	66	73	78	82	84	84	86	76	91
HC 80 T4/T8 5,5/1,1kW (A2:6) (720 RPM - 45°)	Inlet	46	54	60	63	66	66	66	59	72
HC 80 T4/T8 5,5/1,1kW (A2:6) (1420 RPM - 45°)	Inlet	62	69	75	79	82	82	82	75	88
HC 80 T4/T8 5,5/1,1kW (A2:9) (720 RPM - 35°)	Inlet	47	54	59	65	69	71	70	64	76
HC 80 T4/T8 5,5/1,1kW (A2:9) (1420 RPM - 35°)	Inlet	62	69	74	81	85	87	86	80	92
HC 80 T4/T8 5,5/1,1kW (A2:9) (720 RPM - 37,5°)	Inlet	47	54	59	65	69	71	70	64	76
HC 80 T4/T8 5,5/1,1kW (A2:9) (1420 RPM - 37,5°)	Inlet	63	70	75	81	85	87	86	80	91
HC 80 T4/T8 5,5/1,1kW (A2:9) (720 RPM - 40°)	Inlet	48	55	60	65	68	70	70	63	75
HC 80 T4/T8 5,5/1,1kW (A2:9) (1420 RPM - 40°)	Inlet	64	71	76	81	84	86	85	79	91
HC 90 T4/T8 3/0,55kW (A6:3) (1420 RPM - 20°)	Inlet	60	63	72	75	79	80	84	78	87
HC 90 T4/T8 3/0,55kW (A6:3) (720 RPM - 22°)	Inlet	45	49	57	61	65	66	69	63	73

SOUND POWER Lw dB (A)										
Model		63 Hz	125 Hz	250 Hz	500 Hz	1000 Hz	2000 Hz	4000 Hz	8000 Hz	Total
HC 90 T4/T8 3/0,55kW (A6:3) (1420 RPM - 22°)	Inlet	61	65	73	77	81	82	85	79	89
HC 90 T4/T8 4/0,75kW (A6:3) (720 RPM - 24°)	Inlet	47	51	59	63	66	67	70	64	74
HC 90 T4/T8 4/0,75kW (A6:3) (1420 RPM - 24°)	Inlet	62	67	75	79	82	83	86	80	90
HC 90 T4/T8 4/0,75kW (A6:3) (720 RPM - 26°)	Inlet	47	52	60	65	67	68	71	65	75
HC 90 T4/T8 4/0,75kW (A6:3) (1420 RPM - 26°)	Inlet	63	68	76	81	83	84	87	81	91
HC 90 T4/T8 4/0,75kW (A6:3) (720 RPM - 28°)	Inlet	48	53	61	67	68	69	71	66	76
HC 90 T4/T8 4/0,75kW (A6:3) (1420 RPM - 28°)	Inlet	64	69	77	82	84	85	87	82	92
HC 90 T4/T8 5,5/1,1kW (A6:3) (720 RPM - 30°)	Inlet	49	55	62	68	70	71	72	66	77
HC 90 T4/T8 5,5/1,1kW (A6:3) (1420 RPM - 30°)	Inlet	65	71	78	84	85	86	88	82	93
HC 90 T4/T8 5,5/1,1kW (A6:3) (720 RPM - 32°)	Inlet	49	55	62	70	70	71	73	67	78
HC 90 T4/T8 5,5/1,1kW (A6:3) (1420 RPM - 32°)	Inlet	65	71	78	86	86	87	88	83	94
HC 90 T4/T8 5,5/1,1kW (A6:6) (1420 RPM - 20°)	Inlet	65	75	81	88	92	90	91	86	97
HC 90 T4/T8 5,5/1,1kW (A6:6) (720 RPM - 22°)	Inlet	50	59	65	73	76	75	75	71	82
HC 90 T4/T8 5,5/1,1kW (A6:6) (1420 RPM - 22°)	Inlet	66	75	81	89	92	91	91	86	97
HC 90 T4/T8 7,5/1,5kW (A6:3) (720 RPM - 34°)	Inlet	50	56	63	71	71	72	73	67	78
HC 90 T4/T8 7,5/1,5kW (A6:3) (1420 RPM - 34°)	Inlet	66	72	79	87	87	88	89	83	94
HC 90 T4/T8 7,5/1,5kW (A6:3) (720 RPM - 36°)	Inlet	50	56	63	72	72	73	73	68	79
HC 90 T4/T8 7,5/1,5kW (A6:3) (1420 RPM - 36°)	Inlet	66	72	79	88	87	89	89	84	95
HC 90 T4/T8 7,5/1,5kW (A6:6) (720 RPM - 24°)	Inlet	51	60	66	74	76	75	76	71	82
HC 90 T4/T8 7,5/1,5kW (A6:6) (1420 RPM - 24°)	Inlet	67	76	82	89	92	91	92	87	98
HC 90 T4/T8 7,5/1,5kW (A6:6) (720 RPM - 26°)	Inlet	52	61	67	74	76	76	77	72	82
HC 90 T4/T8 7,5/1,5kW (A6:6) (1420 RPM - 26°)	Inlet	67	77	82	90	92	91	92	88	98
HC 90 T4/T8 7,5/1,5kW (A6:6) (720 RPM - 28°)	Inlet	52	61	67	74	76	76	77	72	83

SOUND POWER Lw dB (A)										
Model		63 Hz	125 Hz	250 Hz	500 Hz	1000 Hz	2000 Hz	4000 Hz	8000 Hz	Total
HC 90 T4/T8 7,5/1,5kW (A6:6) (1420 RPM - 28°)	Inlet	68	77	83	90	92	92	93	88	98
HC 90 T4/T8 11/3kW (A6:3) (720 RPM - 38°)	Inlet	50	58	64	73	73	74	74	69	80
HC 90 T4/T8 11/3kW (A6:3) (1420 RPM - 38°)	Inlet	66	73	80	89	89	90	90	85	96
HC 90 T4/T8 11/3kW (A6:3) (720 RPM - 40°)	Inlet	50	58	65	74	74	75	75	70	81
HC 90 T4/T8 11/3kW (A6:3) (1420 RPM - 40°)	Inlet	66	74	81	89	90	91	91	86	97
HC 90 T4/T8 11/3kW (A6:6) (720 RPM - 30°)	Inlet	53	62	67	75	76	76	77	73	83
HC 90 T4/T8 11/3kW (A6:6) (1420 RPM - 30°)	Inlet	69	78	83	90	92	92	93	89	99
HC 90 T4/T8 11/3kW (A6:6) (720 RPM - 32°)	Inlet	52	61	66	73	74	75	76	71	81
HC 90 T4/T8 11/3kW (A6:6) (1420 RPM - 32°)	Inlet	68	77	82	89	90	90	92	87	97
HC 90 T4/T8 11/3kW (A6:6) (720 RPM - 34°)	Inlet	50	59	64	71	72	73	75	69	80
HC 90 T4/T8 11/3kW (A6:6) (1420 RPM - 34°)	Inlet	66	75	80	87	88	89	91	85	95
HC 90 T4/T8 15/3,5kW (A6:6) (720 RPM - 36°)	Inlet	50	59	64	70	72	73	74	69	79
HC 90 T4/T8 15/3,5kW (A6:6) (1420 RPM - 36°)	Inlet	66	75	80	86	88	89	90	85	95
HC 90 T4/T8 15/3,5kW (A6:6) (720 RPM - 38°)	Inlet	51	60	65	71	72	73	75	69	80
HC 90 T4/T8 15/3,5kW (A6:6) (1420 RPM - 38°)	Inlet	67	76	81	87	88	89	91	85	96
HC 90 T4/T8 15/3,5kW (A6:6) (720 RPM - 40°)	Inlet	52	60	65	72	73	74	75	69	80
HC 90 T4/T8 15/3,5kW (A6:6) (1420 RPM - 40°)	Inlet	68	76	81	88	89	90	91	85	96
HC 100 T4/T8 5,5/1,1kW (A6:3) (1420 RPM - 20°)	Inlet	64	71	76	81	87	88	92	84	95
HC 100 T4/T8 5,5/1,1kW (A6:3) (1420 RPM - 22°)	Inlet	64	71	76	81	87	88	92	84	95
HC 100 T4/T8 5,5/1,1kW (A6:3) (720 RPM - 24°)	Inlet	50	56	62	67	71	73	76	69	79
HC 100 T4/T8 5,5/1,1kW (A6:3) (1420 RPM - 24°)	Inlet	66	72	78	83	87	88	91	85	95
HC 100 T4/T8 5,5/1,1kW (A6:3) (720 RPM - 26°)	Inlet	50	56	62	67	71	72	75	68	79
HC 100 T4/T8 5,5/1,1kW (A6:3) (1420 RPM - 26°)	Inlet	66	72	78	83	87	88	91	84	94

SOUND POWER Lw dB (A)

Model		63 Hz	125 Hz	250 Hz	500 Hz	1000 Hz	2000 Hz	4000 Hz	8000 Hz	Total
HC 100 T4/T8 7,5/1,5kW (A6:3) (720 RPM - 28°)	Inlet	50	56	62	68	71	72	74	68	78
HC 100 T4/T8 7,5/1,5kW (A6:3) (1420 RPM - 28°)	Inlet	66	72	78	83	86	88	90	84	94
HC 100 T4/T8 7,5/1,5kW (A6:3) (720 RPM - 30°)	Inlet	50	56	62	68	70	71	73	67	78
HC 100 T4/T8 7,5/1,5kW (A6:3) (1420 RPM - 30°)	Inlet	66	72	78	84	86	87	89	83	94
HC 100 T4/T8 7,5/1,5kW (A6:6) (1420 RPM - 20°)	Inlet	69	80	85	95	96	95	95	91	102
HC 100 T4/T8 7,5/1,5kW (A6:6) (720 RPM - 22°)	Inlet	53	64	69	79	79	79	79	75	86
HC 100 T4/T8 7,5/1,5kW (A6:6) (1420 RPM - 22°)	Inlet	69	80	85	95	95	95	95	91	102
HC 100 T4/T8 11/3kW (A6:3) (720 RPM - 32°)	Inlet	52	57	64	70	72	73	74	68	79
HC 100 T4/T8 11/3kW (A6:3) (1420 RPM - 32°)	Inlet	68	73	80	85	87	88	90	84	95
HC 100 T4/T8 11/3kW (A6:3) (720 RPM - 34°)	Inlet	53	59	65	71	73	74	74	69	80
HC 100 T4/T8 11/3kW (A6:3) (1420 RPM - 34°)	Inlet	69	75	81	87	89	90	90	85	96
HC 100 T4/T8 11/3kW (A6:3) (720 RPM - 36°)	Inlet	54	59	66	72	74	74	75	70	81
HC 100 T4/T8 11/3kW (A6:3) (1420 RPM - 36°)	Inlet	69	75	82	88	90	90	91	86	96
HC 100 T4/T8 11/3kW (A6:6) (720 RPM - 24°)	Inlet	54	64	69	78	79	79	79	75	86
HC 100 T4/T8 11/3kW (A6:6) (1420 RPM - 24°)	Inlet	70	80	85	94	95	95	95	91	102
HC 100 T4/T8 11/3kW (A6:6) (720 RPM - 26°)	Inlet	55	65	70	79	79	79	80	75	86
HC 100 T4/T8 11/3kW (A6:6) (1420 RPM - 26°)	Inlet	71	81	86	94	95	95	96	91	102
HC 100 T4/T8 11/3kW (A6:6) (720 RPM - 28°)	Inlet	57	65	71	79	79	80	81	76	87
HC 100 T4/T8 11/3kW (A6:6) (1420 RPM - 28°)	Inlet	73	81	87	95	95	95	96	92	103
HC 100 T4/T8 15/3,5kW (A6:3) (720 RPM - 38°)	Inlet	53	60	66	73	74	75	75	71	81
HC 100 T4/T8 15/3,5kW (A6:3) (1420 RPM - 38°)	Inlet	69	76	82	89	90	91	91	86	97
HC 100 T4/T8 15/3,5kW (A6:3) (720 RPM - 40°)	Inlet	53	61	66	74	75	76	76	71	82
HC 100 T4/T8 15/3,5kW (A6:3) (1420 RPM - 40°)	Inlet	69	77	82	90	91	92	92	87	98

SOUND POWER Lw dB (A)										
Model		63 Hz	125 Hz	250 Hz	500 Hz	1000 Hz	2000 Hz	4000 Hz	8000 Hz	Total
HC 100 T4/T8 15/3,5kW (A6:6) (720 RPM - 30°)	Inlet	57	65	72	78	79	79	81	76	86
HC 100 T4/T8 15/3,5kW (A6:6) (1420 RPM - 30°)	Inlet	73	81	87	94	95	95	97	92	102
HC 100 T4/T8 15/3,5kW (A6:6) (720 RPM - 32°)	Inlet	57	65	71	76	78	78	79	74	85
HC 100 T4/T8 15/3,5kW (A6:6) (1420 RPM - 32°)	Inlet	72	80	86	92	94	94	95	90	101
HC 100 T4/T8 17/4,3kW (A6:6) (720 RPM - 34°)	Inlet	56	64	70	74	76	77	78	73	83
HC 100 T4/T8 17/4,3kW (A6:6) (1420 RPM - 34°)	Inlet	72	80	86	90	92	93	94	89	99
HC 100 T4/T8 17/4,3kW (A6:6) (720 RPM - 36°)	Inlet	55	63	69	73	76	76	78	72	83
HC 100 T4/T8 17/4,3kW (A6:6) (1420 RPM - 36°)	Inlet	71	79	85	89	92	92	94	88	99
HC 100 T4/T8 20/5kW (A6:6) (720 RPM - 38°)	Inlet	56	64	70	74	77	77	78	73	84
HC 100 T4/T8 20/5kW (A6:6) (1420 RPM - 38°)	Inlet	72	80	86	90	92	93	94	89	99
HC 112 T4/T8 5,5/1,1kW (A6:3) (1420 RPM - 20°)	Inlet	67	74	79	86	91	92	94	89	99
HC 112 T4/T8 5,5/1,1kW (A6:3) (720 RPM - 22°)	Inlet	53	60	65	71	76	77	79	74	83
HC 112 T4/T8 5,5/1,1kW (A6:3) (1420 RPM - 22°)	Inlet	69	76	81	87	92	93	95	90	99
HC 112 T4/T8 7,5/1,5kW (A6:3) (720 RPM - 24°)	Inlet	54	61	66	72	76	77	80	74	84
HC 112 T4/T8 7,5/1,5kW (A6:3) (1420 RPM - 24°)	Inlet	70	77	82	88	92	93	95	90	100
HC 112 T4/T8 7,5/1,5kW (A6:3) (720 RPM - 26°)	Inlet	55	61	67	73	76	77	80	75	84
HC 112 T4/T8 7,5/1,5kW (A6:3) (1420 RPM - 26°)	Inlet	71	77	83	89	92	93	96	90	100
HC 112 T4/T8 11/3kW (A6:3) (720 RPM - 28°)	Inlet	55	61	67	73	76	77	79	74	84
HC 112 T4/T8 11/3kW (A6:3) (1420 RPM - 28°)	Inlet	71	77	83	89	92	93	95	90	100
HC 112 T4/T8 11/3kW (A6:3) (720 RPM - 30°)	Inlet	55	61	67	73	76	76	79	74	83
HC 112 T4/T8 11/3kW (A6:3) (1420 RPM - 30°)	Inlet	71	77	83	89	92	92	95	90	99
HC 112 T4/T8 11/3kW (A6:6) (1420 RPM - 20°)	Inlet	69	80	86	97	98	97	98	93	104
HC 112 T4/T8 11/3kW (A6:6) (720 RPM - 22°)	Inlet	54	65	70	81	82	81	82	77	88

SOUND POWER Lw dB (A)										
Model		63 Hz	125 Hz	250 Hz	500 Hz	1000 Hz	2000 Hz	4000 Hz	8000 Hz	Total
HC 112 T4/T8 11/3kW (A6:6) (1420 RPM - 22°)	Inlet	70	80	86	96	98	97	98	93	104
HC 112 T4/T8 15/3,5kW (A6:3) (720 RPM - 32°)	Inlet	56	61	68	74	76	76	79	74	83
HC 112 T4/T8 15/3,5kW (A6:3) (1420 RPM - 32°)	Inlet	72	77	84	89	92	92	94	90	99
HC 112 T4/T8 15/3,5kW (A6:3) (720 RPM - 34°)	Inlet	57	61	69	74	76	76	78	74	83
HC 112 T4/T8 15/3,5kW (A6:3) (1420 RPM - 34°)	Inlet	73	77	85	90	92	92	94	90	99
HC 112 T4/T8 15/3,5kW (A6:3) (720 RPM - 36°)	Inlet	57	62	69	74	76	77	78	74	83
HC 112 T4/T8 15/3,5kW (A6:3) (1420 RPM - 36°)	Inlet	73	78	85	90	92	93	94	90	99
HC 112 T4/T8 15/3,5kW (A6:6) (720 RPM - 24°)	Inlet	55	64	70	80	81	80	81	76	87
HC 112 T4/T8 15/3,5kW (A6:6) (1420 RPM - 24°)	Inlet	71	80	86	95	97	96	97	92	103
HC 112 T4/T8 15/3,5kW (A6:6) (720 RPM - 26°)	Inlet	57	65	70	79	81	81	82	76	88
HC 112 T4/T8 15/3,5kW (A6:6) (1420 RPM - 26°)	Inlet	72	81	86	95	97	97	98	92	104
HC 112 T4/T8 15/3,5kW (A6:6) (720 RPM - 28°)	Inlet	58	66	71	79	81	81	82	76	88
HC 112 T4/T8 15/3,5kW (A6:6) (1420 RPM - 28°)	Inlet	74	82	87	95	97	97	98	92	104
HC 112 T4/T8 17/4,3kW (A6:3) (720 RPM - 38°)	Inlet	57	63	69	75	77	78	78	74	84
HC 112 T4/T8 17/4,3kW (A6:3) (1420 RPM - 38°)	Inlet	73	79	85	91	93	93	94	90	100
HC 112 T4/T8 17/4,3kW (A6:6) (720 RPM - 30°)	Inlet	59	66	71	78	80	81	82	75	87
HC 112 T4/T8 17/4,3kW (A6:6) (1420 RPM - 30°)	Inlet	75	82	87	94	96	97	98	91	103
HC 112 T4/T8 20/5kW (A6:3) (720 RPM - 40°)	Inlet	57	63	69	75	77	78	78	74	84
HC 112 T4/T8 20/5kW (A6:3) (1420 RPM - 40°)	Inlet	73	79	85	91	93	94	94	90	100
HC 112 T4/T8 20/5kW (A6:6) (720 RPM - 32°)	Inlet	59	66	71	77	79	80	81	74	86
HC 112 T4/T8 20/5kW (A6:6) (1420 RPM - 32°)	Inlet	74	81	86	92	95	96	97	90	102
HC 112 T4/T8 28/6,5kW (A6:6) (720 RPM - 34°)	Inlet	58	65	70	75	78	79	80	73	85
HC 112 T4/T8 28/6,5kW (A6:6) (1420 RPM - 34°)	Inlet	74	81	86	91	94	95	96	89	101

SOUND POWER Lw dB (A)										
Model		63 Hz	125 Hz	250 Hz	500 Hz	1000 Hz	2000 Hz	4000 Hz	8000 Hz	Total
HC 112 T4/T8 28/6,5kW (A6:6) (720 RPM - 36°)	Inlet	59	66	71	75	78	80	80	73	86
HC 112 T4/T8 28/6,5kW (A6:6) (1420 RPM - 36°)	Inlet	75	82	87	91	94	95	96	89	102
HC 112 T4/T8 28/6,5kW (A6:6) (720 RPM - 38°)	Inlet	61	67	73	77	80	81	82	75	87
HC 112 T4/T8 28/6,5kW (A6:6) (1420 RPM - 38°)	Inlet	77	83	89	92	96	97	98	91	103
HC 112 T4/T8 35/8kW (A6:6) (720 RPM - 40°)	Inlet	62	69	74	78	81	82	83	76	88
HC 112 T4/T8 35/8kW (A6:6) (1420 RPM - 40°)	Inlet	78	85	90	94	97	98	99	92	104
HC 125 T4/T8 11/3kW (A7:4) (720 RPM - 22°)	Inlet	59	70	75	82	86	87	89	85	93
HC 125 T4/T8 11/3kW (A7:4) (1420 RPM - 22°)	Inlet	75	86	91	98	102	103	105	101	109
HC 125 T4/T8 15/3,5kW (A7:4) (720 RPM - 24°)	Inlet	59	69	74	80	84	85	87	82	91
HC 125 T4/T8 15/3,5kW (A7:4) (1420 RPM - 24°)	Inlet	75	85	90	96	100	101	103	98	107
HC 125 T4/T8 15/3,5kW (A7:4) (720 RPM - 26°)	Inlet	60	68	73	78	82	83	85	80	90
HC 125 T4/T8 15/3,5kW (A7:4) (1420 RPM - 26°)	Inlet	76	84	89	94	98	99	101	95	106
HC 125 T4/T8 15/3,5kW (A7:8) (1420 RPM - 20°)	Inlet	77	85	92	101	107	110	109	104	115
HC 125 T4/T8 17/4,3kW (A7:4) (720 RPM - 28°)	Inlet	59	66	71	77	80	82	83	77	88
HC 125 T4/T8 17/4,3kW (A7:4) (1420 RPM - 28°)	Inlet	75	82	87	92	96	98	99	93	104
HC 125 T4/T8 20/5kW (A7:4) (720 RPM - 30°)	Inlet	58	65	70	74	78	80	81	74	86
HC 125 T4/T8 20/5kW (A7:4) (1420 RPM - 30°)	Inlet	74	81	86	90	94	96	97	90	102
HC 125 T4/T8 20/5kW (A7:8) (720 RPM - 22°)	Inlet	62	69	75	83	90	93	92	87	97
HC 125 T4/T8 20/5kW (A7:8) (1420 RPM - 22°)	Inlet	77	85	91	99	106	109	108	103	113
HC 125 T4/T8 28/6,5kW (A7:4) (720 RPM - 32°)	Inlet	58	65	70	74	78	79	80	73	85
HC 125 T4/T8 28/6,5kW (A7:4) (1420 RPM - 32°)	Inlet	74	81	86	90	93	95	96	89	101
HC 125 T4/T8 28/6,5kW (A7:4) (720 RPM - 34°)	Inlet	57	64	69	74	77	79	80	72	85
HC 125 T4/T8 28/6,5kW (A7:4) (1420 RPM - 34°)	Inlet	73	80	85	90	93	95	96	88	101

SOUND POWER Lw dB (A)										
Model		63 Hz	125 Hz	250 Hz	500 Hz	1000 Hz	2000 Hz	4000 Hz	8000 Hz	Total
HC 125 T4/T8 28/6,5kW (A7:4) (720 RPM - 36°)	Inlet	58	65	70	75	77	79	80	72	85
HC 125 T4/T8 28/6,5kW (A7:4) (1420 RPM - 36°)	Inlet	74	81	86	90	93	95	96	88	101
HC 125 T4/T8 28/6,5kW (A7:8) (720 RPM - 24°)	Inlet	61	68	75	82	89	91	91	85	96
HC 125 T4/T8 28/6,5kW (A7:8) (1420 RPM - 24°)	Inlet	77	84	91	98	105	107	107	101	112
HC 125 T4/T8 28/6,5kW (A7:8) (720 RPM - 26°)	Inlet	61	68	74	81	87	90	90	84	95
HC 125 T4/T8 28/6,5kW (A7:8) (1420 RPM - 26°)	Inlet	77	84	90	97	103	106	106	99	111
HC 125 T4/T8 35/8kW (A7:4) (720 RPM - 38°)	Inlet	59	66	71	76	78	80	81	73	86
HC 125 T4/T8 35/8kW (A7:4) (1420 RPM - 38°)	Inlet	75	82	87	91	94	96	96	89	102
HC 125 T4/T8 35/8kW (A7:4) (720 RPM - 40°)	Inlet	59	66	71	76	78	80	81	74	86
HC 125 T4/T8 35/8kW (A7:4) (1420 RPM - 40°)	Inlet	75	82	87	92	94	96	96	90	102
HC 125 T4/T8 35/8kW (A7:8) (720 RPM - 28°)	Inlet	61	68	74	80	86	89	89	82	94
HC 125 T4/T8 35/8kW (A7:8) (1420 RPM - 28°)	Inlet	77	83	90	96	102	105	105	98	110
HC 125 T4/T8 35/8kW (A7:8) (720 RPM - 30°)	Inlet	61	67	73	79	84	87	87	80	92
HC 125 T4/T8 35/8kW (A7:8) (1420 RPM - 30°)	Inlet	77	83	89	95	100	103	103	96	108
HC 125 T4/T8 37/9,2kW (A7:8) (720 RPM - 32°)	Inlet	61	67	73	79	83	85	86	78	90
HC 125 T4/T8 37/9,2kW (A7:8) (1420 RPM - 32°)	Inlet	77	83	89	94	99	101	102	94	106
HC 125 T4/T8 44/11kW (A7:8) (720 RPM - 34°)	Inlet	61	68	73	78	82	84	84	76	89
HC 125 T4/T8 44/11kW (A7:8) (1420 RPM - 34°)	Inlet	77	83	89	94	98	100	100	92	105

ERP DATA

ERP	
Fan type	Axial fan
Installation category	A
Efficiency category	Static
The fan has to be installed with FSC	NO

ERP / 2 poles

Model	Mot. power (kW)	Maximum efficiency point data						
		Max. efficiency (%)	Efficiency grade (N)	Air Flow (m3/h)	Ps (Pa)	Pabs (kW)	Speed (rpm)	Specific Ratio
HC 35 M2 0,55kW (A0:6) (30°)	0,55	36,32	43,50	2.837,83	322,23	0,74	2800	1,00
HC 35 M2 1,1kW (A0:6) (35°)	1,1	36,49	42,85	3.621,61	353,93	0,99	2800	1,00
HC 35 T2 0,55kW (A0:6) (30°)	0,55	36,32	43,50	2.837,83	322,23	0,74	2800	1,00
HC 35 T2 1,1kW (A0:6) (35°)	1,1	38,92	45,45	3.621,60	353,93	0,93	2800	1,00
HC 40 T2 1,1kW (A0:6) (30°)	1,1	39,39	45,28	5.024,53	308,78	1,18	2800	1,00
HC 45 T2 1,5kW (A0:6) (25°)	1,5	47,17	52,37	5.963,51	418,46	1,51	2800	1,00
HC 45 T2 2,2kW (A0:6) (35°)	2,2	46,64	50,91	7.736,77	443,93	2,12	2800	1,00

ERP / 4 poles

Model	Mot. power (kW)	Maximum efficiency point data						
		Max. efficiency (%)	Efficiency grade (N)	Air Flow (m3/h)	Ps (Pa)	Pabs (kW)	Speed (rpm)	Specific Ratio
HC 35 M4 0,12kW (A0:6) (40°)	0,12	25,37	36,38	1.882,54	86,41	0,18	1380	1,00
HC 35 T4 0,12kW (A0:6) (40°)	0,12	25,37	36,38	1.882,54	86,41	0,18	1400	1,00
HC 40 M4 0,25kW (A0:6) (40°)	0,25	29,93	39,71	2.832,37	106,08	0,28	1400	1,00
HC 40 T4 0,25kW (A0:6) (40°)	0,25	31,41	41,32	2.832,37	106,08	0,27	1400	1,00
HC 45 M4 0,37kW (A0:6) (40°)	0,37	27,90	36,87	4.031,59	88,07	0,38	1400	1,00
HC 45 T4 0,55kW (A0:6) (45°)	0,55	32,81	41,31	4.467,33	117,89	0,45	1400	1,00
HC 50 M4 0,55kW (A0:6) (40°)	0,55	34,91	42,59	5.600,18	134,36	0,61	1400	1,00
HC 50 T4 0,55kW (A0:6) (45°)	0,55	34,91	42,59	5.600,18	134,36	0,61	1400	1,00
HC 56 M4 0,37kW (A5:6) (20°)	0,37	39,16	47,30	4.450,98	158,25	0,52	1400	1,00
HC 56 M4 0,55kW (A2:6) (20°)	0,55	38,89	47,20	4.044,51	159,60	0,48	1400	1,00
HC 56 M4 0,55kW (A2:6) (25°)	0,55	38,90	46,29	5.079,11	177,41	0,68	1400	1,00
HC 56 M4 0,55kW (A5:6) (25°)	0,55	40,67	48,26	5.579,79	156,10	0,63	1400	1,00
HC 56 T4 0,37kW (A5:6) (20°)	0,37	39,16	47,30	4.450,98	158,25	0,52	1400	1,00
HC 56 T4 0,55kW (A2:6) (20°)	0,55	38,89	47,20	4.044,51	159,60	0,48	1400	1,00

Model	Mot. power (kW)	Maximum efficiency point data						
		Max. efficiency (%)	Efficiency grade (N)	Air Flow (m3/h)	Ps (Pa)	Pabs (kW)	Speed (rpm)	Specific Ratio
HC 56 T4 0,55kW (A2:6) (25°)	0,55	38,90	46,29	5.079,11	177,41	0,68	1400	1,00
HC 56 T4 0,55kW (A2:9) (20°)	0,55	37,73	45,06	4.058,71	213,78	0,69	1400	1,00
HC 56 T4 0,55kW (A5:6) (25°)	0,55	40,67	48,26	5.579,79	156,10	0,63	1400	1,00
HC 56 T4 0,75kW (A2:6) (27,5°)	0,75	43,99	51,28	5.734,45	186,22	0,71	1390	1,00
HC 56 T4 0,75kW (A2:6) (30°)	0,75	43,09	50,15	6.025,67	189,79	0,77	1390	1,00
HC 56 T4 0,75kW (A2:6) (32,5°)	0,75	41,28	47,96	6.535,55	193,03	0,88	1390	1,00
HC 56 T4 0,75kW (A2:9) (25°)	0,75	44,82	51,79	5.157,47	228,92	0,79	1390	1,00
HC 56 T4 0,75kW (A5:6) (30°)	0,75	42,61	49,73	6.724,10	158,14	0,75	1390	1,00
HC 56 T4 0,75kW (A5:6) (32,5°)	0,75	40,86	47,66	7.150,49	165,55	0,84	1390	1,00
HC 56 T4 1,1kW (A2:9) (27,5°)	1,1	45,64	52,18	5.992,84	236,38	0,92	1400	1,00
HC 56 T4 1,1kW (A2:9) (30°)	1,1	44,95	51,27	6.352,21	239,91	1	1400	1,00
HC 56 T4 1,1kW (A2:9) (32,5°)	1,1	43,48	49,50	6.869,63	242,32	1,12	1400	1,00
HC 56 T4 1,1kW (A2:9) (35°)	1,1	42,11	47,86	7.380,42	245	1,24	1400	1,00
HC 56 T4 1,1kW (A5:6) (35°)	1,1	39,49	46,01	7.592,48	167,07	0,93	1400	1,00
HC 56 T4 1,1kW (A5:6) (37,5°)	1,1	38,19	44,24	8.313,94	173,66	1,11	1400	1,00
HC 56 T4 1,5kW (A5:6) (40°)	1,5	37,56	43,20	9.053,32	177,82	1,28	1400	1,00
HC 63 T4 0,55kW (A2:6) (20°)	0,55	40,93	48,54	5.260,91	166,30	0,63	1400	1,00
HC 63 T4 0,75kW (A2:6) (25°)	0,75	47,89	54,87	6.888,27	187,16	0,79	1390	1,00
HC 63 T4 0,75kW (A2:9) (20°)	0,75	47,89	54,70	5.526,55	241,34	0,84	1390	1,00
HC 63 T4 0,75kW (A5:6) (25°)	0,75	48,90	55,52	7.749,60	190,49	0,90	1390	1,00
HC 63 T4 1,1kW (A2:6) (27,5°)	1,1	49,29	55,79	7.966,26	201,05	0,94	1400	1,00
HC 63 T4 1,1kW (A2:6) (30°)	1,1	48,85	55,10	8.449,86	206,50	1,03	1400	1,00
HC 63 T4 1,1kW (A2:6) (32,5°)	1,1	46,88	52,72	9.219,91	212,37	1,20	1400	1,00
HC 63 T4 1,1kW (A2:9) (25°)	1,1	50,67	56,74	7.174,29	258,99	1,10	1400	1,00
HC 63 T4 1,1kW (A5:6) (30°)	1,1	48,36	54,02	9.471,59	223,11	1,28	1400	1,00
HC 63 T4 1,5kW (A2:6) (35°)	1,5	45,36	50,84	9.987,52	218,17	1,37	1400	1,00
HC 63 T4 1,5kW (A2:6) (37,5°)	1,5	43,42	48,58	10.729,36	219,84	1,53	1400	1,00
HC 63 T4 1,5kW (A2:6) (40°)	1,5	41,51	46,36	11.480,66	221,80	1,72	1400	1,00
HC 63 T4 1,5kW (A2:9) (27,5°)	1,5	49,93	55,39	8.384,96	273,56	1,37	1400	1,00
HC 63 T4 1,5kW (A2:9) (30°)	1,5	49,14	54,34	8.876,93	280,13	1,51	1400	1,00
HC 63 T4 1,5kW (A2:9) (32,5°)	1,5	47,16	51,95	9.819,66	285,37	1,75	1400	1,00
HC 63 T4 1,5kW (A5:6) (32,5°)	1,5	46,28	51,63	10.049,43	224,61	1,43	1400	1,00
HC 63 T4 1,5kW (A5:6) (35°)	1,5	44,66	49,73	10.634,82	229,88	1,58	1400	1,00
HC 63 T4 2,2kW (A2:6) (45°)	2,2	40,27	44,89	12.588,71	211,11	1,87	1430	1,00
HC 63 T4 2,2kW (A2:9) (35°)	2,2	45,66	50,13	10.690,55	291,58	1,97	1430	1,00
HC 63 T4 2,2kW (A2:9) (37,5°)	2,2	44,34	48,55	11.486,98	291,40	2,17	1430	1,00
HC 63 T4 2,2kW (A2:9) (40°)	2,2	42,79	46,74	12.282,15	291,76	2,38	1430	1,00
HC 63 T4 2,2kW (A2:9) (42,5°)	2,2	42,28	46,13	12.682,54	289,33	2,47	1430	1,00

Model	Mot. power (kW)	Maximum efficiency point data						
		Max. efficiency (%)	Efficiency grade (N)	Air Flow (m3/h)	Ps (Pa)	Pabs (kW)	Speed (rpm)	Specific Ratio
HC 63 T4 2,2kW (A5:6) (37,5°)	2,2	42,15	46,86	11.401	228,88	1,81	1430	1,00
HC 63 T4 2,2kW (A5:6) (40°)	2,2	40,29	44,68	12.192,25	230,28	2,03	1430	1,00
HC 63 T4 3kW (A2:9) (45°)	3	40,70	44,29	13.704,56	281,82	2,71	1430	1,00
HC 71 T4 0,75kW (A2:6) (20°)	0,75	50,66	57,75	6.869,32	190,84	0,76	1390	1,00
HC 71 T4 0,75kW (A5:6) (20°)	0,75	49,90	56,29	8.372,10	200,34	0,98	1390	1,00
HC 71 T4 1,1kW (A2:6) (25°)	1,1	52,73	58,78	9.220,18	216,65	1,11	1400	1,00
HC 71 T4 1,1kW (A2:9) (20°)	1,1	52,93	59,06	7.068,49	271,48	1,07	1400	1,00
HC 71 T4 1,1kW (A5:6) (25°)	1,1	48,19	53,62	10.397,53	221,33	1,39	1400	1,00
HC 71 T4 1,5kW (A2:6) (27,5°)	1,5	52,09	57,50	10.912,22	229,75	1,40	1400	1,00
HC 71 T4 1,5kW (A2:6) (30°)	1,5	51	56,11	11.661,78	234,90	1,56	1400	1,00
HC 71 T4 1,5kW (A2:6) (32,5°)	1,5	49,42	54,12	12.767,22	242,94	1,82	1400	1,00
HC 71 T4 1,5kW (A2:9) (25°)	1,5	54,01	59,15	9.622,26	286,74	1,54	1400	1,00
HC 71 T4 1,5kW (A5:6) (30°)	1,5	48,69	53,41	12.484,67	240,66	1,80	1400	1,00
HC 71 T4 2,2kW (A2:6) (35°)	2,2	48,42	52,77	13.900,24	250,94	2,06	1430	1,00
HC 71 T4 2,2kW (A2:6) (37,5°)	2,2	46,76	50,85	14.856,44	249,66	2,26	1430	1,00
HC 71 T4 2,2kW (A2:6) (40°)	2,2	44,69	48,50	15.873,28	248,35	2,51	1430	1,00
HC 71 T4 2,2kW (A2:9) (27,5°)	2,2	53,24	57,78	11.364,26	301,56	1,92	1430	1,00
HC 71 T4 2,2kW (A2:9) (30°)	2,2	52,47	56,76	12.076,33	309,57	2,10	1430	1,00
HC 71 T4 2,2kW (A2:9) (32,5°)	2,2	50,87	54,79	13.241,46	315,36	2,41	1430	1,00
HC 71 T4 2,2kW (A5:6) (32,5°)	2,2	46,08	50,34	13.584,40	248,47	2,13	1430	1,00
HC 71 T4 2,2kW (A5:6) (35°)	2,2	44,44	48,31	14.711,90	256,35	2,46	1430	1,00
HC 71 T4 3kW (A2:6) (45°)	3	40,79	44,17	17.525,73	237,19	2,93	1430	1,00
HC 71 T4 3kW (A2:9) (35°)	3	49,76	53,34	14.476,09	320,58	2,73	1430	1,00
HC 71 T4 3kW (A2:9) (37,5°)	3	47,86	51,12	15.671,19	322,48	3,07	1430	1,00
HC 71 T4 3kW (A5:6) (37,5°)	3	42,73	46,36	15.385,79	256,45	2,67	1430	1,00
HC 71 T4 3kW (A5:6) (40°)	3	41,28	44,71	16.071,79	257,98	2,89	1430	1,00
HC 80 T4 1,1kW (A2:6) (20°)	1,1	54,76	61,15	8.717,96	212,26	0,98	1400	1,00
HC 80 T4 1,5kW (A2:6) (25°)	1,5	55,12	60,30	12.084,38	236,27	1,52	1400	1,00
HC 80 T4 1,5kW (A2:9) (20°)	1,5	54,96	60,20	9.312,63	298,57	1,49	1400	1,00
HC 80 T4 2,2kW (A2:6) (27,5°)	2,2	55,24	59,75	14.418,13	254,06	1,94	1430	1,00
HC 80 T4 2,2kW (A2:6) (30°)	2,2	54,26	58,46	15.422,24	262,37	2,18	1430	1,00
HC 80 T4 2,2kW (A2:6) (32,5°)	2,2	52,93	56,72	16.968,83	270,13	2,53	1430	1,00
HC 80 T4 2,2kW (A2:9) (25°)	2,2	55,64	59,77	12.722,75	323,27	2,24	1430	1,00
HC 80 T4 3kW (A2:6) (35°)	3	52,33	55,77	18.524,04	278,91	2,88	1430	1,00
HC 80 T4 3kW (A2:6) (37,5°)	3	49,42	52,48	20.023,66	281,83	3,30	1430	1,00
HC 80 T4 3kW (A2:9) (27,5°)	3	55	58,54	15.084,16	335,23	2,77	1430	1,00
HC 80 T4 3kW (A2:9) (30°)	3	54,50	57,80	16.131,69	341,20	3,03	1430	1,00
HC 80 T4 3kW (A5:6) (30°)	3	55,68	59,36	17.060,33	297,05	2,63	1430	1,00

Model	Mot. power (kW)	Maximum efficiency point data						
		Max. efficiency (%)	Efficiency grade (N)	Air Flow (m3/h)	Ps (Pa)	Pabs (kW)	Speed (rpm)	Specific Ratio
HC 80 T4 3kW (A5:6) (32,5°)	3	52,36	55,66	18.296,01	296,87	3,02	1430	1,00
HC 80 T4 3kW (A5:6) (35°)	3	49,80	52,77	19.560,26	299,70	3,41	1430	1,00
HC 80 T4 4kW (A2:6) (40°)	4	46,89	49,62	21.482,19	284,61	3,72	1440	1,00
HC 80 T4 4kW (A2:6) (42,5°)	4	44,72	47,25	22.250,17	282,99	4	1440	1,00
HC 80 T4 4kW (A2:9) (32,5°)	4	51,81	54,64	17.915,03	349,60	3,60	1440	1,00
HC 80 T4 4kW (A2:9) (35°)	4	48,42	50,73	19.784,99	357,65	4,32	1440	1,00
HC 80 T4 4kW (A5:6) (37,5°)	4	48,62	51,28	21.096,99	306,23	3,82	1440	1,00
HC 80 T4 4kW (A5:6) (40°)	4	47,80	50,18	22.715,02	308,46	4,22	1440	1,00
HC 80 T4 5,5kW (A2:6) (45°)	5,5	40,21	42,30	24.071,60	277,60	4,69	1440	1,00
HC 80 T4 5,5kW (A2:9) (37,5°)	5,5	47,48	49,53	21.293,55	364,53	4,77	1440	1,00
HC 80 T4 5,5kW (A2:9) (40°)	5,5	46,29	48,05	22.877,51	371,99	5,31	1440	1,00
HC 80 T4 5,5kW (A2:9) (42,5°)	5,5	44,93	46,54	23.818,35	368,51	5,61	1440	1,00
HC 90 T4 3kW (A6:3) (20°)	3	49,24	53,01	17.038,58	253,36	2,54	1430	1,00
HC 90 T4 3kW (A6:3) (22°)	3	49,14	52,47	18.593,33	272,71	2,99	1430	1,00
HC 90 T4 4kW (A6:3) (24°)	4	49,02	51,96	20.176,85	290,07	3,44	1440	1,00
HC 90 T4 4kW (A6:3) (26°)	4	47,64	50,20	21.621,45	305,39	3,95	1440	1,00
HC 90 T4 4kW (A6:3) (28°)	4	46,32	48,52	23.127,77	320,19	4,51	1440	1,00
HC 90 T4 5,5kW (A6:3) (30°)	5,5	44,67	46,56	24.523,24	324,85	5,05	1440	1,00
HC 90 T4 5,5kW (A6:3) (32°)	5,5	42,51	44,07	25.979,43	325,52	5,70	1440	1,00
HC 90 T4 5,5kW (A6:6) (20°)	5,5	52,33	54,63	18.994,33	402,25	4,36	1440	1,00
HC 90 T4 5,5kW (A6:6) (22°)	5,5	52,09	53,95	20.849,42	427,50	5,10	1440	1,00
HC 90 T4 7,5kW (A6:3) (34°)	7,5	40,44	41,70	27.421,18	326,25	6,36	1440	1,00
HC 90 T4 7,5kW (A6:3) (36°)	7,5	37,69	38,61	28.887,19	325,88	7,19	1440	1,00
HC 90 T4 7,5kW (A6:6) (24°)	7,5	52,03	53,52	22.583,12	453,19	5,86	1440	1,00
HC 90 T4 7,5kW (A6:6) (26°)	7,5	50,47	51,56	24.007,62	478,74	6,76	1440	1,00
HC 90 T4 7,5kW (A6:6) (28°)	7,5	49,11	49,82	25.483,88	502,92	7,77	1440	1,00
HC 90 T4 11kW (A6:6) (30°)	11	47,73	48,14	27.036,29	517,97	8,68	1460	1,00
HC 90 T4 11kW (A6:6) (32°)	11	45,83	45,93	28.603,97	528,78	9,71	1460	1,00
HC 90 T4 11kW (A6:6) (34°)	11	44,02	44,05	30.278,42	536,63	10,78	1460	1,00
HC 90 T4 15kW (A6:6) (36°)	15	42,56	42,53	32.348,89	530,89	11,68	1460	1,00
HC 90 T4 15kW (A6:6) (38°)	15	40,84	40,73	34.393,14	529,97	12,77	1460	1,00
HC 90 T4 15kW (A6:6) (40°)	15	38,70	38,52	35.693,49	524,48	13,93	1460	1,00
HC 100 T4 5,5kW (A6:3) (20°)	5,5	55,26	58,08	22.586,33	303,57	3,60	1440	1,00
HC 100 T4 5,5kW (A6:3) (22°)	5,5	54,92	57,78	24.876,14	326,93	3,55	1440	1,00
HC 100 T4 5,5kW (A6:3) (24°)	5,5	53,98	55,89	27.115,65	348	5,01	1440	1,00
HC 100 T4 5,5kW (A6:3) (26°)	5,5	51,93	53,44	29.182,08	364,29	5,80	1440	1,00
HC 100 T4 7,5kW (A6:3) (28°)	7,5	50,50	51,66	31.271,98	379,40	6,61	1440	1,00
HC 100 T4 7,5kW (A6:3) (30°)	7,5	48,09	48,91	33.404,84	381,28	7,47	1440	1,00

Model	Mot. power (kW)	Maximum efficiency point data						
		Max. efficiency (%)	Efficiency grade (N)	Air Flow (m3/h)	Ps (Pa)	Pabs (kW)	Speed (rpm)	Specific Ratio
HC 100 T4 7,5kW (A6:6) (20°)	7,5	55,71	56,99	24.343,21	481,25	6,33	1440	1,00
HC 100 T4 7,5kW (A6:6) (22°)	7,5	55,67	56,47	27.135,33	513,68	7,53	1440	1,00
HC 100 T4 11kW (A6:3) (32°)	11	46	46,52	35.700,53	378,41	8,34	1460	1,00
HC 100 T4 11kW (A6:3) (34°)	11	42,98	43,16	37.709,85	376,65	9,43	1460	1,00
HC 100 T4 11kW (A6:3) (36°)	11	40,08	40,13	39.152,83	372,58	10,53	1460	1,00
HC 100 T4 11kW (A6:6) (24°)	11	55,82	56,24	29.855,14	541,52	8,67	1460	1,00
HC 100 T4 11kW (A6:6) (26°)	11	55,05	55,13	32.630,11	557,41	9,78	1460	1,00
HC 100 T4 11kW (A6:6) (28°)	11	53,63	53,63	35.488,84	574,93	11,11	1460	1,00
HC 100 T4 15kW (A6:6) (30°)	15	51,97	51,88	38.100,43	584,23	12,47	1460	1,00
HC 100 T4 15kW (A6:6) (32°)	15	50,07	49,90	40.698,13	591,56	13,95	1460	1,00
HC 100 T4 18,5kW (A6:6) (34°)	18,5	48,12	47,86	43.258,41	598,12	15,55	1465	1,00
HC 100 T4 18,5kW (A6:6) (36°)	18,5	45,61	45,26	45.749,12	601,46	17,37	1465	1,00
HC 100 T4 22kW (A6:6) (38°)	22	43,50	43,08	48.316,64	603,86	19,22	1470	1,00
HC 100 T4 22kW (A6:6) (40°)	22	41,11	40,62	50.228,34	595,14	20,96	1470	1,00
HC 112 T4 5,5kW (A6:3) (20°)	5,5	52,66	54,65	27.306,06	330,01	4,88	1440	1,00
HC 112 T4 5,5kW (A6:3) (22°)	5,5	54,25	55,76	30.997,21	358,03	5,82	1440	1,00
HC 112 T4 7,5kW (A6:3) (24°)	7,5	54,90	55,97	34.623,10	381,96	6,82	1440	1,00
HC 112 T4 7,5kW (A6:3) (26°)	7,5	53,05	53,66	38.016,12	397,60	8,05	1440	1,00
HC 112 T4 11kW (A6:3) (28°)	11	51,95	52,16	41.611,52	412,38	9,32	1460	1,00
HC 112 T4 11kW (A6:3) (30°)	11	49,77	49,81	44.242,32	420,80	10,58	1460	1,00
HC 112 T4 11kW (A6:6) (20°)	11	54,88	55,27	30.082,65	539,13	8,72	1460	1,00
HC 112 T4 11kW (A6:6) (22°)	11	55,93	55,99	34.046,39	574,11	10,34	1460	1,00
HC 112 T4 15kW (A6:3) (32°)	15	47,99	47,94	46.861,26	428,16	11,84	1460	1,00
HC 112 T4 15kW (A6:3) (34°)	15	45,05	44,90	49.204,26	432,78	13,44	1460	1,00
HC 112 T4 15kW (A6:3) (36°)	15	42,11	41,87	51.227,83	432,64	15,09	1460	1,00
HC 112 T4 15kW (A6:6) (24°)	15	56,68	56,62	37.975,26	606,49	12	1460	1,00
HC 112 T4 15kW (A6:6) (26°)	15	56,60	56,43	42.073,29	625,95	13,77	1460	1,00
HC 112 T4 15kW (A6:6) (28°)	15	56,36	56,09	46.246,85	646,55	15,69	1460	1,00
HC 112 T4 18,5kW (A6:3) (38°)	18,5	39,21	38,89	53.213,23	431,91	16,92	1465	1,00
HC 112 T4 18,5kW (A6:6) (30°)	18,5	55,23	54,87	49.777,71	670,80	17,71	1465	1,00
HC 112 T4 22kW (A6:6) (32°)	22	54,11	53,66	53.425,81	693,47	19,83	1470	1,00
HC 112 T4 22kW (A6:6) (34°)	22	52,42	51,89	56.927	709,72	22,10	1470	1,00
HC 112 T4 30kW (A6:6) (36°)	30	50,27	49,65	60.259,07	714,30	24,46	1475	1,00
HC 112 T4 30kW (A6:6) (38°)	30	47,93	47,23	63.563,76	719,57	27,13	1475	1,00
HC 112 T4 30kW (A6:6) (40°)	30	45,08	44,31	66.879,03	709,13	29,95	1475	1,00
HC 125 T4 11kW (A7:4) (20°)	11	50,56	50,75	36.598,97	451,89	9,42	1460	1,00
HC 125 T4 11kW (A7:4) (22°)	11	52,76	52,77	41.381,22	490,92	11,07	1460	1,00
HC 125 T4 15kW (A7:4) (24°)	15	54,08	53,97	46.299,44	524,29	12,87	1460	1,00

Model	Mot. power (kW)	Maximum efficiency point data						
		Max. efficiency (%)	Efficiency grade (N)	Air Flow (m3/h)	Ps (Pa)	Pabs (kW)	Speed (rpm)	Specific Ratio
HC 125 T4 15kW (A7:4) (26°)	15	53,91	53,68	51.353,96	552,14	15,01	1460	1,00
HC 125 T4 15kW (A7:8) (20°)	15	52,26	51,99	39.157,13	716,62	15,77	1460	1,00
HC 125 T4 18,5kW (A7:4) (28°)	18,5	53,91	53,56	56.643,01	578,72	17,27	1465	1,00
HC 125 T4 18,5kW (A7:4) (30°)	18,5	52,29	51,84	60.854,33	594,58	19,69	1465	1,00
HC 125 T4 18,5kW (A7:8) (22°)	18,5	53,09	52,68	44.346,10	765,42	18,80	1465	1,00
HC 125 T4 22kW (A7:4) (32°)	22	50,53	49,99	65.025,18	610,99	22,31	1470	1,00
HC 125 T4 22kW (A7:8) (24°)	22	53,73	53,20	49.919,85	809,99	22,10	1470	1,00
HC 125 T4 30kW (A7:4) (34°)	30	48,16	47,52	68.749,63	620,53	25,10	1475	1,00
HC 125 T4 30kW (A7:4) (36°)	30	45,11	44,38	72.444,23	614,48	28,19	1475	1,00
HC 125 T4 30kW (A7:8) (26°)	30	54,82	54,18	56.057,61	847,78	25,48	1475	1,00
HC 125 T4 30kW (A7:8) (28°)	30	55,29	54,54	62.225,48	888,81	29,39	1475	1,00
HC 125 T4 37kW (A7:8) (30°)	37	54,34	53,49	67.473,87	910,36	33,08	1475	1,00
HC 125 T4 37kW (A7:8) (32°)	37	53,08	52,14	72.689,59	929,84	37,24	1475	1,00
HC 125 T4 45kW (A7:8) (34°)	45	51,54	50,52	77.693,38	950,51	41,53	1475	1,00
HC 125 T4 45kW (A7:8) (36°)	45	50,43	49,32	83.131,28	959,99	46,25	1475	1,00

ERP / 6 poles

Model	Mot. power (kW)	Maximum efficiency point data						
		Max. efficiency (%)	Efficiency grade (N)	Air Flow (m3/h)	Ps (Pa)	Pabs (kW)	Speed (rpm)	Specific Ratio
HC 45 M6 0,13kW (A0:6) (45°)	0,13	25,97	37,40	2.887,40	49,55	0,16	920	1,00
HC 45 T6 0,13kW (A0:6) (45°)	0,13	26,43	37,91	2.887,40	49,55	0,15	920	1,00
HC 50 M6 0,13kW (A0:6) (45°)	0,13	29,27	40,04	3.636,18	56,31	0,20	920	1,00
HC 50 T6 0,13kW (A0:6) (45°)	0,13	29,27	40,04	3.636,18	56,31	0,20	920	1,00
HC 56 M6 0,25kW (A2:6) (20°)	0,55	37,73	49,53	2.618,06	67,01	0,14	870	1,00
HC 56 M6 0,25kW (A2:6) (25°)	0,55	37,78	48,65	3.290,52	74,56	0,19	870	1,00
HC 56 M6 0,25kW (A2:6) (27,5°)	0,55	35,98	46,28	3.720,36	78,10	0,24	870	1,00
HC 56 M6 0,25kW (A2:6) (30°)	0,55	35,18	45,24	3.905,40	79,61	0,26	870	1,00
HC 56 M6 0,25kW (A2:6) (32,5°)	0,55	33,70	43,39	4.236,90	81,15	0,29	870	1,00
HC 56 M6 0,25kW (A2:6) (35°)	0,55	32,40	41,73	4.575,43	82,53	0,33	870	1,00
HC 56 M6 0,25kW (A2:6) (37,5°)	0,55	31,22	40,30	4.886,93	82,18	0,37	870	1,00
HC 56 M6 0,25kW (A5:6) (30°)	0,25	26,78	36,19	4.271,14	68,72	0,33	870	1,00
HC 56 M6 0,25kW (A5:6) (32,5°)	0,25	27,74	36,93	4.582,34	72,80	0,35	870	1,00
HC 56 M6 0,25kW (A5:6) (35°)	0,25	28,82	37,81	4.864,42	77,53	0,38	870	1,00
HC 56 M6 0,37kW (A5:6) (37,5°)	0,37	30,31	39,11	5.318,94	80,35	0,41	890	1,00
HC 56 M6 0,37kW (A5:6) (40°)	0,37	31,90	40,51	5.744,66	83,54	0,44	890	1,00

Model	Mot. power (kW)	Maximum efficiency point data						
		Max. efficiency (%)	Efficiency grade (N)	Air Flow (m3/h)	Ps (Pa)	Pabs (kW)	Speed (rpm)	Specific Ratio
HC 56 T6 0,25kW (A5:6) (30°)	0,25	26,78	36,19	4.271,14	68,72	0,33	900	1,00
HC 56 T6 0,25kW (A5:6) (32,5°)	0,25	27,74	36,93	4.582,34	72,80	0,35	900	1,00
HC 56 T6 0,25kW (A5:6) (35°)	0,25	28,82	37,81	4.864,42	77,53	0,38	900	1,00
HC 56 T6 0,37kW (A5:6) (37,5°)	0,37	30,31	39,11	5.318,94	80,35	0,41	900	1,00
HC 56 T6 0,37kW (A5:6) (40°)	0,37	31,90	40,51	5.744,66	83,54	0,44	900	1,00
HC 56 T6 0,55kW (A2:9) (20°)	0,55	36,62	47,44	2.632,92	89,63	0,19	900	1,00
HC 56 T6 0,55kW (A2:9) (25°)	0,55	36,53	46,51	3.341,50	95,93	0,26	900	1,00
HC 56 T6 0,55kW (A2:9) (27,5°)	0,55	35,37	44,80	3.880,39	99,20	0,32	900	1,00
HC 56 T6 0,55kW (A2:9) (30°)	0,55	34,84	44,04	4.113,59	100,74	0,35	900	1,00
HC 56 T6 0,55kW (A2:9) (32,5°)	0,55	33,76	42,65	4.449,87	101,65	0,39	900	1,00
HC 56 T6 0,55kW (A2:9) (35°)	0,55	32,66	41,27	4.788,49	102,55	0,43	900	1,00
HC 56 T6 0,55kW (A2:9) (37,5°)	0,55	31,38	39,73	5.119,29	102,25	0,48	900	1,00
HC 56 T6 0,55kW (A2:9) (40°)	0,55	30,10	38,18	5.461,11	101,52	0,53	900	1,00
HC 56 T6 0,55kW (A2:9) (42,5°)	0,55	29,34	37,26	5.649,54	101,96	0,56	900	1,00
HC 56 T6 0,55kW (A2:9) (45°)	0,55	27,60	35,17	6.102,14	102,89	0,64	900	1,00
HC 63 M6 0,37kW (A5:6) (35°)	0,37	34,33	42,68	7.125,79	79,11	0,48	890	1,00
HC 63 M6 0,55kW (A2:9) (20°)	0,55	39,08	48,90	3.579,19	101,46	0,28	890	1,00
HC 63 M6 0,55kW (A2:9) (25°)	0,55	39,37	48,31	4.652,77	108,59	0,39	890	1,00
HC 63 M6 0,55kW (A2:9) (27,5°)	0,55	38,17	46,46	5.426,28	114,90	0,49	890	1,00
HC 63 M6 0,55kW (A2:9) (30°)	0,55	37,71	45,75	5.763,40	117,74	0,54	890	1,00
HC 63 M6 0,55kW (A2:9) (32,5°)	0,55	35,99	43,62	6.350,37	119,73	0,62	890	1,00
HC 63 M6 0,55kW (A2:9) (35°)	0,55	34,53	41,78	6.937,81	122,53	0,72	890	1,00
HC 63 M6 0,55kW (A2:9) (37,5°)	0,55	33,38	40,37	7.444,91	122,36	0,79	890	1,00
HC 63 M6 0,55kW (A5:6) (37,5°)	0,55	34,80	42,77	7.553,35	87,18	0,55	890	1,00
HC 63 M6 0,55kW (A5:6) (40°)	0,55	35,49	43,12	7.980,88	94,79	0,62	890	1,00
HC 63 T6 0,37kW (A5:6) (35°)	0,37	34,33	42,68	7.125,79	79,11	0,48	900	1,00
HC 63 T6 0,55kW (A2:9) (20°)	0,55	39,08	48,90	3.579,19	101,46	0,28	900	1,00
HC 63 T6 0,55kW (A2:9) (25°)	0,55	39,37	48,31	4.652,77	108,59	0,39	900	1,00
HC 63 T6 0,55kW (A2:9) (27,5°)	0,55	38,17	46,46	5.426,28	114,90	0,49	900	1,00
HC 63 T6 0,55kW (A2:9) (30°)	0,55	37,71	45,75	5.763,40	117,74	0,54	900	1,00
HC 63 T6 0,55kW (A2:9) (32,5°)	0,55	35,99	43,62	6.350,37	119,73	0,62	900	1,00
HC 63 T6 0,55kW (A2:9) (35°)	0,55	34,53	41,78	6.937,81	122,53	0,72	900	1,00
HC 63 T6 0,55kW (A2:9) (37,5°)	0,55	33,38	40,37	7.444,91	122,36	0,79	900	1,00
HC 63 T6 0,55kW (A5:6) (37,5°)	0,55	34,80	42,77	7.553,35	87,18	0,55	900	1,00
HC 63 T6 0,55kW (A5:6) (40°)	0,55	35,49	43,12	7.980,88	94,79	0,62	900	1,00
HC 63 T6 0,75kW (A2:9) (40°)	0,75	39,18	46,45	7.944,08	122,86	0,71	910	1,00
HC 63 T6 0,75kW (A2:9) (45°)	0,75	36,84	43,73	8.888,20	118,82	0,82	910	1,00
HC 71 M6 0,55kW (A2:6) (20°)	0,55	41,40	51,50	4.446,72	80,22	0,25	890	1,00

Model	Mot. power (kW)	Maximum efficiency point data						
		Max. efficiency (%)	Efficiency grade (N)	Air Flow (m3/h)	Ps (Pa)	Pabs (kW)	Speed (rpm)	Specific Ratio
HC 71 M6 0,55kW (A2:6) (25°)	0,55	41,04	49,96	5.975,43	91,17	0,39	890	1,00
HC 71 M6 0,55kW (A2:6) (27,5°)	0,55	39,83	48,07	7.059,87	96,95	0,50	890	1,00
HC 71 M6 0,55kW (A2:6) (30°)	0,55	39,08	47,01	7.544,57	98,89	0,56	890	1,00
HC 71 M6 0,55kW (A2:6) (32,5°)	0,55	37,74	45,27	8.264,30	102,16	0,65	890	1,00
HC 71 M6 0,55kW (A2:6) (35°)	0,55	36,48	43,62	9.000,05	106,02	0,75	890	1,00
HC 71 M6 0,55kW (A2:6) (37,5°)	0,55	35,11	41,99	9.639,37	104,36	0,82	890	1,00
HC 71 M6 0,55kW (A2:9) (20°)	0,55	41	50	4.573,69	114,08	0,38	890	1,00
HC 71 M6 0,55kW (A2:9) (25°)	0,55	41,36	49,34	6.232,52	120,80	0,55	890	1,00
HC 71 M6 0,55kW (A2:9) (27,5°)	0,55	39,99	47,33	7.341,10	127	0,69	890	1,00
HC 71 M6 0,55kW (A2:9) (30°)	0,55	39,35	46,43	7.802,30	129,68	0,76	890	1,00
HC 71 T6 0,55kW (A2:6) (20°)	0,55	41,40	51,50	4.446,72	80,22	0,25	900	1,00
HC 71 T6 0,55kW (A2:6) (25°)	0,55	41,04	49,96	5.975,43	91,17	0,39	900	1,00
HC 71 T6 0,55kW (A2:6) (27,5°)	0,55	39,83	48,07	7.059,87	96,95	0,50	900	1,00
HC 71 T6 0,55kW (A2:6) (30°)	0,55	39,08	47,01	7.544,57	98,89	0,56	900	1,00
HC 71 T6 0,55kW (A2:6) (32,5°)	0,55	37,74	45,27	8.264,30	102,16	0,65	900	1,00
HC 71 T6 0,55kW (A2:6) (35°)	0,55	36,48	43,62	9.000,05	106,02	0,75	900	1,00
HC 71 T6 0,55kW (A2:6) (37,5°)	0,55	35,11	41,99	9.639,37	104,36	0,82	900	1,00
HC 71 T6 0,55kW (A2:9) (20°)	0,55	41	50	4.573,69	114,08	0,38	900	1,00
HC 71 T6 0,55kW (A2:9) (25°)	0,55	41,36	49,34	6.232,52	120,80	0,55	900	1,00
HC 71 T6 0,55kW (A2:9) (27,5°)	0,55	39,99	47,33	7.341,10	127	0,69	900	1,00
HC 71 T6 0,55kW (A2:9) (30°)	0,55	39,35	46,43	7.802,30	129,68	0,76	900	1,00
HC 71 T6 0,75kW (A2:6) (40°)	0,75	40,74	47,87	10.283,96	104,14	0,75	910	1,00
HC 71 T6 0,75kW (A2:6) (45°)	0,75	36,78	43,46	11.362,70	99,33	0,88	910	1,00
HC 71 T6 0,75kW (A2:9) (32,5°)	0,75	46,42	53,65	8.589,10	131,97	0,72	910	1,00
HC 71 T6 0,75kW (A2:9) (35°)	0,75	44,96	51,82	9.376,53	134,55	0,82	910	1,00
HC 71 T6 0,75kW (A2:9) (37,5°)	0,75	43,18	49,72	10.144,23	135,39	0,92	910	1,00
HC 71 T6 0,75kW (A5:6) (35°)	0,75	35,49	42,50	9.362,64	103,18	0,78	910	1,00
HC 71 T6 0,75kW (A5:6) (37,5°)	0,75	33,55	40,29	9.840,66	100,67	0,86	910	1,00
HC 71 T6 0,75kW (A5:6) (40°)	0,75	31,91	38,41	10.328,24	101,24	0,94	910	1,00
HC 71 T6 1,1kW (A2:9) (40°)	1,1	42,70	49	10.946,69	135,89	1,01	910	1,00
HC 71 T6 1,1kW (A2:9) (42,5°)	1,1	41,46	47,63	11.326,60	134,81	1,06	910	1,00
HC 71 T6 1,1kW (A2:9) (45°)	1,1	38,91	44,78	12.244,32	131,81	1,18	910	1,00
HC 80 T6 0,75kW (A2:6) (20°)	0,75	51,65	61,44	5.659,76	88,98	0,28	910	1,00
HC 80 T6 0,75kW (A2:6) (25°)	0,75	51,21	59,75	7.840	98,60	0,45	910	1,00
HC 80 T6 0,75kW (A2:6) (27,5°)	0,75	50,48	58,31	9.327,07	106,90	0,58	910	1,00
HC 80 T6 0,75kW (A2:6) (30°)	0,75	49,45	56,97	9.995,22	109,62	0,65	910	1,00
HC 80 T6 0,75kW (A2:6) (32,5°)	0,75	48,60	55,71	11.007,98	113,61	0,75	910	1,00
HC 80 T6 0,75kW (A2:6) (35°)	0,75	47,33	54,05	12.022	117,04	0,87	910	1,00

Model	Mot. power (kW)	Maximum efficiency point data						
		Max. efficiency (%)	Efficiency grade (N)	Air Flow (m3/h)	Ps (Pa)	Pabs (kW)	Speed (rpm)	Specific Ratio
HC 80 T6 0,75kW (A2:9) (20°)	0,75	51,15	59,75	6.039,64	125,58	0,44	910	1,00
HC 80 T6 0,75kW (A2:9) (25°)	0,75	50,78	58,23	8.247,01	135,76	0,67	910	1,00
HC 80 T6 0,75kW (A2:9) (27,5°)	0,75	49,68	56,51	9.763,49	141,33	0,83	910	1,00
HC 80 T6 0,75kW (A2:9) (30°)	0,75	49,16	55,74	10.452,65	142,94	0,91	910	1,00
HC 80 T6 0,75kW (A5:6) (30°)	0,75	48,82	55,52	11.351,24	130,06	0,87	910	1,00
HC 80 T6 1,1kW (A2:6) (37,5°)	1,1	45,63	52,06	12.932,13	118,34	0,97	910	1,00
HC 80 T6 1,1kW (A2:6) (40°)	1,1	42,97	49,02	13.905,12	119,50	1,10	910	1,00
HC 80 T6 1,1kW (A2:6) (42,5°)	1,1	40,97	46,83	14.413,14	118,38	1,19	910	1,00
HC 80 T6 1,1kW (A2:9) (32,5°)	1,1	47,56	53,72	11.618,99	147,10	1,07	910	1,00
HC 80 T6 1,1kW (A2:9) (35°)	1,1	44,35	50	12.800,43	150,44	1,28	910	1,00
HC 80 T6 1,1kW (A5:6) (32,5°)	1,1	48,07	54,43	12.170,74	135,71	0,99	910	1,00
HC 80 T6 1,1kW (A5:6) (35°)	1,1	47,76	53,81	12.992,65	140,55	1,11	910	1,00
HC 80 T6 1,5kW (A2:6) (45°)	1,5	37,05	42,50	15.583,74	116,39	1,38	940	1,00
HC 80 T6 1,5kW (A2:9) (37,5°)	1,5	44,17	49,57	13.839,19	153,38	1,40	940	1,00
HC 80 T6 1,5kW (A2:9) (40°)	1,5	42,82	47,92	14.809,78	156,28	1,56	940	1,00
HC 80 T6 1,5kW (A2:9) (42,5°)	1,5	41,39	46,35	15.398,36	154,31	1,65	940	1,00
HC 80 T6 1,5kW (A5:6) (37,5°)	1,5	45,66	51,42	13.963,94	139,11	1,23	940	1,00
HC 80 T6 1,5kW (A5:6) (40°)	1,5	44,04	49,53	14.943,38	138,87	1,36	940	1,00
HC 80 T6 2,2kW (A2:9) (45°)	2,2	39,15	43,82	16.841,74	150,78	1,84	940	1,00
HC 80 T6 2,2kW (A5:6) (42,5°)	2,2	37,82	42,75	16.483,69	133,86	1,67	940	1,00
HC 90 T6 1,5kW (A6:3) (20°)	1,5	46,53	53,71	11.049,13	106,04	0,73	940	1,00
HC 90 T6 1,5kW (A6:3) (22°)	1,5	44,19	50,81	12.040,66	114	0,90	940	1,00
HC 90 T6 1,5kW (A6:3) (24°)	1,5	45,04	51,32	13.102,42	121,72	1,02	940	1,00
HC 90 T6 1,5kW (A6:3) (26°)	1,5	43,55	49,45	13.995,03	128,23	1,17	940	1,00
HC 90 T6 1,5kW (A6:3) (28°)	1,5	42,43	47,96	14.944,10	135,05	1,34	940	1,00
HC 90 T6 1,5kW (A6:3) (30°)	1,5	41,34	46,58	15.917,03	136,16	1,49	940	1,00
HC 90 T6 1,5kW (A6:3) (32°)	1,5	39,35	44,27	16.809,08	136,87	1,67	940	1,00
HC 90 T6 1,5kW (A6:6) (20°)	1,5	48,31	53,96	12.310,53	168,90	1,28	940	1,00
HC 90 T6 1,5kW (A6:6) (22°)	1,5	48,29	53,50	13.505,88	180,16	1,50	940	1,00
HC 90 T6 1,5kW (A6:6) (24°)	1,5	47,78	52,60	14.647,73	190,42	1,74	940	1,00
HC 90 T6 2,2kW (A6:3) (34°)	2,2	37,87	42,52	17.780,14	136,86	1,85	940	1,00
HC 90 T6 2,2kW (A6:3) (36°)	2,2	35,24	39,56	18.724,46	136,48	2,09	940	1,00
HC 90 T6 2,2kW (A6:3) (38°)	2,2	32,77	36,74	19.695,80	135,90	2,36	940	1,00
HC 90 T6 2,2kW (A6:6) (26°)	2,2	47,31	51,79	15.582,28	200,59	1,97	940	1,00
HC 90 T6 2,2kW (A6:6) (28°)	2,2	45,84	49,93	16.508,24	211,14	2,26	940	1,00
HC 90 T6 2,2kW (A6:6) (30°)	2,2	44,25	48,02	17.521,81	217,17	2,55	940	1,00
HC 90 T6 3kW (A6:6) (32°)	3	43,13	46,63	18.538,35	222,48	2,81	960	1,00
HC 90 T6 3kW (A6:6) (34°)	3	41,37	44,59	19.650,23	224,54	3,12	960	1,00

Model	Mot. power (kW)	Maximum efficiency point data						
		Max. efficiency (%)	Efficiency grade (N)	Air Flow (m3/h)	Ps (Pa)	Pabs (kW)	Speed (rpm)	Specific Ratio
HC 90 T6 3kW (A6:6) (36°)	3	39,76	42,73	20.938,71	223,55	3,41	960	1,00
HC 90 T6 4kW (A6:6) (38°)	4	38,59	41,36	22.286,60	222,21	3,67	960	1,00
HC 90 T6 4kW (A6:6) (40°)	4	36,53	39,06	23.107,01	219,93	4,01	960	1,00
HC 100 T6 1,5kW (A6:3) (20°)	1,5	51,16	57,33	14.633,57	127,64	1,06	940	1,00
HC 100 T6 1,5kW (A6:3) (22°)	1,5	50,86	56,56	16.135,36	137,29	1,26	940	1,00
HC 100 T6 1,5kW (A6:3) (24°)	1,5	49,88	55,15	17.589,13	145,98	1,48	940	1,00
HC 100 T6 1,5kW (A6:3) (26°)	1,5	48,13	53	18.925,84	152,83	1,71	940	1,00
HC 100 T6 2,2kW (A6:3) (28°)	2,2	47,28	51,82	20.251,64	159,59	1,92	940	1,00
HC 100 T6 2,2kW (A6:3) (30°)	2,2	45	49,21	21.655,26	159,68	2,17	940	1,00
HC 100 T6 2,2kW (A6:3) (32°)	2,2	42,52	46,40	23.101,11	158,96	2,45	940	1,00
HC 100 T6 2,2kW (A6:6) (20°)	2,2	52,24	56,90	15.778	202,55	1,84	940	1,00
HC 100 T6 2,2kW (A6:6) (22°)	2,2	52,06	56,24	17.553,65	216,02	2,19	940	1,00
HC 100 T6 2,2kW (A6:6) (24°)	2,2	51,77	55,54	19.371,57	226,97	2,55	940	1,00
HC 100 T6 3kW (A6:3) (34°)	3	40,48	44,07	24.437,67	158,30	2,73	960	1,00
HC 100 T6 3kW (A6:3) (36°)	3	37,64	40,92	25.341,47	156,32	3,05	960	1,00
HC 100 T6 3kW (A6:6) (26°)	3	51,77	55,25	21.130,05	233,99	2,83	960	1,00
HC 100 T6 3kW (A6:6) (28°)	3	50,38	53,51	22.985,89	241,37	3,22	960	1,00
HC 100 T6 4kW (A6:6) (30°)	4	49,19	52,02	24.663,05	244,95	3,58	960	1,00
HC 100 T6 4kW (A6:6) (32°)	4	47,35	49,86	26.363,33	248,26	4,02	960	1,00
HC 100 T6 5,5kW (A6:6) (34°)	5,5	45,94	48,19	28.013,51	251,12	4,44	960	1,00
HC 100 T6 5,5kW (A6:6) (36°)	5,5	43,59	45,54	29.655,60	251,84	4,94	960	1,00
HC 100 T6 5,5kW (A6:6) (38°)	5,5	41,40	43,06	31.327,21	253,54	5,50	960	1,00
HC 100 T6 7,5kW (A6:6) (40°)	7,5	39,55	41	32.552,02	249,75	5,93	965	1,00
HC 112 T6 2,2kW (A6:3) (20°)	2,2	48,67	54,01	17.663,44	138,88	1,43	940	1,00
HC 112 T6 2,2kW (A6:3) (22°)	2,2	50,13	54,99	20.083,71	150,52	1,71	940	1,00
HC 112 T6 2,2kW (A6:3) (24°)	2,2	51,43	55,89	22.448,74	160,06	1,98	940	1,00
HC 112 T6 2,2kW (A6:3) (26°)	2,2	49,71	53,71	24.666,23	166,82	2,34	940	1,00
HC 112 T6 2,2kW (A6:6) (20°)	2,2	50,77	54,53	19.469,18	226,39	2,56	940	1,00
HC 112 T6 3kW (A6:3) (28°)	3	48,85	52,46	26.933,70	173,25	2,69	960	1,00
HC 112 T6 3kW (A6:3) (30°)	3	46,88	50,15	28.670,07	177,02	3,06	960	1,00
HC 112 T6 3kW (A6:3) (32°)	3	44,65	47,58	30.325,90	179,95	3,46	960	1,00
HC 112 T6 3kW (A6:6) (22°)	3	52,55	55,88	22.033,24	241,42	2,99	960	1,00
HC 112 T6 3kW (A6:6) (24°)	3	52,74	55,63	24.619,37	254,58	3,51	960	1,00
HC 112 T6 4kW (A6:3) (34°)	4	42,56	45,18	31.869,26	181,68	3,86	960	1,00
HC 112 T6 4kW (A6:3) (36°)	4	39,73	42,04	33.163,20	181,48	4,34	960	1,00
HC 112 T6 4kW (A6:6) (26°)	4	53,43	55,98	27.277,52	262,50	3,97	960	1,00
HC 112 T6 4kW (A6:6) (28°)	4	53,34	55,54	29.954	271,77	4,52	960	1,00
HC 112 T6 5,5kW (A6:6) (30°)	5,5	52,72	54,62	32.264,04	281,42	5,04	960	1,00

Model	Mot. power (kW)	Maximum efficiency point data						
		Max. efficiency (%)	Efficiency grade (N)	Air Flow (m3/h)	Ps (Pa)	Pabs (kW)	Speed (rpm)	Specific Ratio
HC 112 T6 5,5kW (A6:6) (32°)	5,5	51,38	52,95	34.613,85	291,08	5,68	960	1,00
HC 112 T6 7,5kW (A6:6) (34°)	7,5	50,50	51,81	36.917,55	298,05	6,25	965	1,00
HC 112 T6 7,5kW (A6:6) (36°)	7,5	48,09	49,11	39.059,20	299,94	6,96	965	1,00
HC 112 T6 7,5kW (A6:6) (38°)	7,5	45,84	46,57	41.197,43	302,20	7,72	965	1,00
HC 112 T6 11kW (A6:6) (40°)	11	43,54	44,04	43.201,03	298,10	8,41	970	1,00
HC 125 T6 3kW (A7:4) (20°)	3	47,66	51,24	23.707,37	190,07	2,72	960	1,00
HC 125 T6 3kW (A7:4) (22°)	3	49,56	52,70	26.786,32	206,52	3,20	960	1,00
HC 125 T6 4kW (A7:4) (24°)	4	51,11	53,86	29.962,16	220,31	3,70	960	1,00
HC 125 T6 4kW (A7:4) (26°)	4	50,89	53,21	33.253,17	231,61	4,32	960	1,00
HC 125 T6 5,5kW (A7:4) (28°)	5,5	51,47	53,43	36.692,25	243,05	4,92	960	1,00
HC 125 T6 5,5kW (A7:4) (30°)	5,5	49,87	51,48	39.379,74	250,06	5,60	960	1,00
HC 125 T6 5,5kW (A7:8) (20°)	5,5	49,88	52,10	25.267,62	301,94	4,48	960	1,00
HC 125 T6 5,5kW (A7:8) (22°)	5,5	50,62	52,36	28.758,19	320,60	5,35	960	1,00
HC 125 T6 7,5kW (A7:4) (32°)	7,5	48,53	49,81	42.093,44	256,76	6,31	965	1,00
HC 125 T6 7,5kW (A7:4) (34°)	7,5	46,27	47,21	44.722,16	259,70	7,14	965	1,00
HC 125 T6 7,5kW (A7:4) (36°)	7,5	43,42	44,05	47.114,88	257,74	8,02	965	1,00
HC 125 T6 7,5kW (A7:8) (24°)	7,5	51,77	53,08	32.420,23	339,13	6,24	965	1,00
HC 125 T6 7,5kW (A7:8) (26°)	7,5	52,42	53,33	36.294,27	356,30	7,25	965	1,00
HC 125 T6 11kW (A7:8) (28°)	11	53,60	54,14	40.297,84	373,57	8,25	970	1,00
HC 125 T6 11kW (A7:8) (30°)	11	52,38	52,60	43.692,63	381,99	9,33	970	1,00
HC 125 T6 11kW (A7:8) (32°)	11	51,12	51,17	47.063,91	390,88	10,49	970	1,00
HC 125 T6 11kW (A7:8) (34°)	11	49,85	49,81	50.429,59	397,94	11,71	970	1,00
HC 125 T6 15kW (A7:8) (36°)	15	48,79	48,68	53.758,73	403,42	12,94	970	1,00
HC 125 T6 15kW (A7:8) (38°)	15	46,53	46,32	56.998,53	409,20	14,59	970	1,00
HC 125 T6 15kW (A7:8) (40°)	15	44,08	43,80	59.793,88	406,49	15,96	970	1,00

ERP / 4/6 poles

Model	Mot. power (kW)	Maximum efficiency point data						
		Max. efficiency (%)	Efficiency grade (N)	Air Flow (m3/h)	Ps (Pa)	Pabs (kW)	Speed (rpm)	Specific Ratio
HC 45 T4/T6 0,55/0,18kW (A0:6) (45°)	0,55	32,81	41,31	4.467,33	117,89	0,45	1410	1,00
HC 50 T4/T6 0,55/0,18kW (A0:6) (45°)	0,55	34,91	42,59	5.600,18	134,36	0,61	1410	1,00
HC 56 T4/T6 0,37/0,13kW (A5:6) (20°)	0,37	39,16	47,30	4.450,98	158,25	0,52	1380	1,00
HC 56 T4/T6 0,55/0,18kW (A2:6) (20°)	0,55	38,89	47,20	4.044,51	159,60	0,48	1410	1,00
HC 56 T4/T6 0,55/0,18kW (A2:6) (25°)	0,55	38,90	46,29	5.079,11	177,41	0,68	1410	1,00
HC 56 T4/T6 0,55/0,18kW (A2:9) (20°)	0,55	37,73	45,06	4.058,71	213,78	0,69	1410	1,00

Model	Mot. power (kW)	Maximum efficiency point data						
		Max. efficiency (%)	Efficiency grade (N)	Air Flow (m3/h)	Ps (Pa)	Pabs (kW)	Speed (rpm)	Specific Ratio
HC 56 T4/T6 0,55/0,18kW (A5:6) (25°)	0,55	40,67	48,26	5.579,79	156,10	0,63	1410	1,00
HC 56 T4/T6 0,75/0,25kW (A2:6) (27,5°)	0,75	43,99	51,28	5.734,45	186,22	0,71	1420	1,00
HC 56 T4/T6 0,75/0,25kW (A2:6) (30°)	0,75	43,09	50,15	6.025,67	189,79	0,77	1420	1,00
HC 56 T4/T6 0,75/0,25kW (A2:6) (32,5°)	0,75	41,28	47,96	6.535,55	193,03	0,88	1420	1,00
HC 56 T4/T6 0,75/0,25kW (A2:9) (25°)	0,75	44,82	51,79	5.157,47	228,92	0,79	1420	1,00
HC 56 T4/T6 0,75/0,25kW (A5:6) (30°)	0,75	42,61	49,73	6.724,10	158,14	0,75	1420	1,00
HC 56 T4/T6 0,75/0,25kW (A5:6) (32,5°)	0,75	40,86	47,66	7.150,49	165,55	0,84	1420	1,00
HC 56 T4/T6 1,1/0,37kW (A2:9) (27,5°)	1,1	45,64	52,18	5.992,84	236,38	0,92	1430	1,00
HC 56 T4/T6 1,1/0,37kW (A2:9) (30°)	1,1	44,95	51,27	6.352,21	239,91	1	1430	1,00
HC 56 T4/T6 1,1/0,37kW (A2:9) (32,5°)	1,1	43,48	49,50	6.869,63	242,32	1,12	1430	1,00
HC 56 T4/T6 1,1/0,37kW (A2:9) (35°)	1,1	42,11	47,86	7.380,42	245	1,24	1430	1,00
HC 56 T4/T6 1,1/0,37kW (A5:6) (35°)	1,1	39,49	46,01	7.592,48	167,07	0,93	1430	1,00
HC 56 T4/T6 1,1/0,37kW (A5:6) (37,5°)	1,1	38,19	44,24	8.313,94	173,66	1,11	1430	1,00
HC 56 T4/T6 1,5/0,5kW (A5:6) (40°)	1,5	37,56	43,20	9.053,32	177,82	1,28	1430	1,00
HC 63 T4/T6 0,55/0,18kW (A2:6) (20°)	0,55	40,93	48,54	5.260,91	166,30	0,63	1410	1,00
HC 63 T4/T6 0,75/0,25kW (A2:6) (25°)	0,75	47,89	54,87	6.888,27	187,16	0,79	1420	1,00
HC 63 T4/T6 0,75/0,25kW (A2:9) (20°)	0,75	47,89	54,70	5.526,55	241,34	0,84	1420	1,00
HC 63 T4/T6 0,75/0,25kW (A5:6) (25°)	0,75	48,90	55,52	7.749,60	190,49	0,90	1420	1,00
HC 63 T4/T6 1,1/0,37kW (A2:6) (27,5°)	1,1	49,29	55,79	7.966,26	201,05	0,94	1430	1,00
HC 63 T4/T6 1,1/0,37kW (A2:6) (30°)	1,1	48,85	55,10	8.449,86	206,50	1,03	1430	1,00
HC 63 T4/T6 1,1/0,37kW (A2:6) (32,5°)	1,1	46,88	52,72	9.219,91	212,37	1,20	1430	1,00
HC 63 T4/T6 1,1/0,37kW (A2:9) (25°)	1,1	50,67	56,74	7.174,29	258,99	1,10	1430	1,00
HC 63 T4/T6 1,1/0,37kW (A5:6) (30°)	1,1	48,36	54,02	9.471,59	223,11	1,28	1430	1,00
HC 63 T4/T6 1,5/0,5kW (A2:6) (35°)	1,5	45,36	50,84	9.987,52	218,17	1,37	1430	1,00
HC 63 T4/T6 1,5/0,5kW (A2:6) (37,5°)	1,5	43,42	48,58	10.729,36	219,84	1,53	1430	1,00
HC 63 T4/T6 1,5/0,5kW (A2:6) (40°)	1,5	41,51	46,36	11.480,66	221,80	1,72	1430	1,00
HC 63 T4/T6 1,5/0,5kW (A2:9) (27,5°)	1,5	49,93	55,39	8.384,96	273,56	1,37	1430	1,00
HC 63 T4/T6 1,5/0,5kW (A2:9) (30°)	1,5	49,14	54,34	8.876,93	280,13	1,51	1430	1,00
HC 63 T4/T6 1,5/0,5kW (A2:9) (32,5°)	1,5	47,16	51,95	9.819,66	285,37	1,75	1430	1,00
HC 63 T4/T6 1,5/0,5kW (A5:6) (32,5°)	1,5	46,28	51,63	10.049,43	224,61	1,43	1430	1,00
HC 63 T4/T6 1,5/0,5kW (A5:6) (35°)	1,5	44,66	49,73	10.634,82	229,88	1,58	1430	1,00
HC 63 T4/T6 2,2/0,6kW (A2:6) (45°)	2,2	40,27	44,89	12.588,71	211,11	1,87	1430	1,00
HC 63 T4/T6 2,2/0,6kW (A2:9) (35°)	2,2	45,66	50,13	10.690,55	291,58	1,97	1430	1,00
HC 63 T4/T6 2,2/0,6kW (A2:9) (37,5°)	2,2	44,34	48,55	11.486,98	291,40	2,17	1430	1,00
HC 63 T4/T6 2,2/0,6kW (A2:9) (40°)	2,2	42,79	46,74	12.282,15	291,76	2,38	1430	1,00
HC 63 T4/T6 2,2/0,6kW (A2:9) (42,5°)	2,2	42,28	46,13	12.682,54	289,33	2,47	1430	1,00
HC 63 T4/T6 2,2/0,6kW (A5:6) (37,5°)	2,2	42,15	46,86	11.401	228,88	1,81	1430	1,00
HC 63 T4/T6 2,2/0,6kW (A5:6) (40°)	2,2	40,29	44,68	12.192,25	230,28	2,03	1430	1,00

Model	Mot. power (kW)	Maximum efficiency point data						
		Max. efficiency (%)	Efficiency grade (N)	Air Flow (m3/h)	Ps (Pa)	Pabs (kW)	Speed (rpm)	Specific Ratio
HC 63 T4/T6 3/0,9kW (A2:9) (45°)	3	40,70	44,29	13.704,56	281,82	2,71	1440	1,00
HC 71 T4/T6 0,75/0,25kW (A2:6) (20°)	0,75	50,66	57,75	6.869,32	190,84	0,76	1420	1,00
HC 71 T4/T6 0,75/0,25kW (A5:6) (20°)	0,75	49,90	56,29	8.372,10	200,34	0,98	1420	1,00
HC 71 T4/T6 1,1/0,37kW (A2:6) (25°)	1,1	52,73	58,78	9.220,18	216,65	1,11	1430	1,00
HC 71 T4/T6 1,1/0,37kW (A2:9) (20°)	1,1	52,93	59,06	7.068,49	271,48	1,07	1430	1,00
HC 71 T4/T6 1,1/0,37kW (A5:6) (25°)	1,1	48,19	53,62	10.397,53	221,33	1,39	1430	1,00
HC 71 T4/T6 1,5/0,5kW (A2:6) (27,5°)	1,5	52,09	57,50	10.912,22	229,75	1,40	1430	1,00
HC 71 T4/T6 1,5/0,5kW (A2:6) (30°)	1,5	51	56,11	11.661,78	234,90	1,56	1430	1,00
HC 71 T4/T6 1,5/0,5kW (A2:6) (32,5°)	1,5	49,42	54,12	12.767,22	242,94	1,82	1430	1,00
HC 71 T4/T6 1,5/0,5kW (A2:9) (25°)	1,5	54,01	59,15	9.622,26	286,74	1,54	1430	1,00
HC 71 T4/T6 1,5/0,5kW (A5:6) (30°)	1,5	48,69	53,41	12.484,67	240,66	1,80	1430	1,00
HC 71 T4/T6 2,2/0,6kW (A2:6) (35°)	2,2	48,42	52,77	13.900,24	250,94	2,06	1430	1,00
HC 71 T4/T6 2,2/0,6kW (A2:6) (37,5°)	2,2	46,76	50,85	14.856,44	249,66	2,26	1430	1,00
HC 71 T4/T6 2,2/0,6kW (A2:6) (40°)	2,2	44,69	48,50	15.873,28	248,35	2,51	1430	1,00
HC 71 T4/T6 2,2/0,6kW (A2:9) (27,5°)	2,2	53,24	57,78	11.364,26	301,56	1,92	1430	1,00
HC 71 T4/T6 2,2/0,6kW (A2:9) (30°)	2,2	52,47	56,76	12.076,33	309,57	2,10	1430	1,00
HC 71 T4/T6 2,2/0,6kW (A2:9) (32,5°)	2,2	50,87	54,79	13.241,46	315,36	2,41	1430	1,00
HC 71 T4/T6 2,2/0,6kW (A5:6) (32,5°)	2,2	46,08	50,34	13.584,40	248,47	2,13	1430	1,00
HC 71 T4/T6 2,2/0,6kW (A5:6) (35°)	2,2	44,44	48,31	14.711,90	256,35	2,46	1430	1,00
HC 71 T4/T6 3/0,9kW (A2:6) (45°)	3	40,79	44,17	17.525,73	237,19	2,93	1440	1,00
HC 71 T4/T6 3/0,9kW (A2:9) (35°)	3	49,76	53,34	14.476,09	320,58	2,73	1440	1,00
HC 71 T4/T6 3/0,9kW (A2:9) (37,5°)	3	47,86	51,12	15.671,19	322,48	3,07	1440	1,00
HC 71 T4/T6 3/0,9kW (A5:6) (37,5°)	3	42,73	46,36	15.385,79	256,45	2,67	1440	1,00
HC 71 T4/T6 3/0,9kW (A5:6) (40°)	3	41,28	44,71	16.071,79	257,98	2,89	1440	1,00
HC 80 T4/T6 1,1/0,37kW (A2:6) (20°)	1,1	54,76	61,15	8.717,96	212,26	0,98	1430	1,00
HC 80 T4/T6 1,5/0,5kW (A2:6) (25°)	1,5	55,12	60,30	12.084,38	236,27	1,52	1430	1,00
HC 80 T4/T6 1,5/0,5kW (A2:9) (20°)	1,5	54,96	60,20	9.312,63	298,57	1,49	1430	1,00
HC 80 T4/T6 2,2/0,6kW (A2:6) (27,5°)	2,2	55,24	59,75	14.418,13	254,06	1,94	1430	1,00
HC 80 T4/T6 2,2/0,6kW (A2:6) (30°)	2,2	54,26	58,46	15.422,24	262,37	2,18	1430	1,00
HC 80 T4/T6 2,2/0,6kW (A2:6) (32,5°)	2,2	52,93	56,72	16.968,83	270,13	2,53	1430	1,00
HC 80 T4/T6 2,2/0,6kW (A2:9) (25°)	2,2	55,64	59,77	12.722,75	323,27	2,24	1430	1,00
HC 80 T4/T6 3/0,9kW (A2:6) (35°)	3	52,33	55,77	18.524,04	278,91	2,88	1440	1,00
HC 80 T4/T6 3/0,9kW (A2:6) (37,5°)	3	49,42	52,48	20.023,66	281,83	3,30	1440	1,00
HC 80 T4/T6 3/0,9kW (A2:9) (27,5°)	3	55	58,54	15.084,16	335,23	2,77	1440	1,00
HC 80 T4/T6 3/0,9kW (A2:9) (30°)	3	54,50	57,80	16.131,69	341,20	3,03	1440	1,00
HC 80 T4/T6 3/0,9kW (A5:6) (30°)	3	55,68	59,36	17.060,33	297,05	2,63	1440	1,00
HC 80 T4/T6 3/0,9kW (A5:6) (32,5°)	3	52,36	55,66	18.296,01	296,87	3,02	1440	1,00
HC 80 T4/T6 3/0,9kW (A5:6) (35°)	3	49,80	52,77	19.560,26	299,70	3,41	1440	1,00

Model	Mot. power (kW)	Maximum efficiency point data						
		Max. efficiency (%)	Efficiency grade (N)	Air Flow (m3/h)	Ps (Pa)	Pabs (kW)	Speed (rpm)	Specific Ratio
HC 80 T4/T6 4/1,1kW (A2:6) (40°)	4	46,89	49,62	21.482,19	284,61	3,72	1430	1,00
HC 80 T4/T6 4/1,1kW (A2:6) (42,5°)	4	44,72	47,25	22.250,17	282,99	4	1430	1,00
HC 80 T4/T6 4/1,1kW (A2:9) (32,5°)	4	51,81	54,64	17.915,03	349,60	3,60	1430	1,00
HC 80 T4/T6 4/1,1kW (A2:9) (35°)	4	48,42	50,73	19.784,99	357,65	4,32	1430	1,00
HC 80 T4/T6 4/1,1kW (A5:6) (37,5°)	4	48,62	51,28	21.096,99	306,23	3,82	1430	1,00
HC 80 T4/T6 4/1,1kW (A5:6) (40°)	4	47,80	50,18	22.715,02	308,46	4,22	1430	1,00
HC 80 T4/T6 5,5/1,85kW (A2:6) (45°)	5,5	40,21	42,30	24.071,60	277,60	4,69	1450	1,00
HC 80 T4/T6 5,5/1,85kW (A2:9) (37,5°)	5,5	47,48	49,53	21.293,55	364,53	4,77	1450	1,00
HC 80 T4/T6 5,5/1,85kW (A2:9) (40°)	5,5	46,29	48,05	22.877,51	371,99	5,31	1450	1,00
HC 80 T4/T6 5,5/1,85kW (A2:9) (42,5°)	5,5	44,93	46,54	23.818,35	368,51	5,61	1450	1,00
HC 90 T4/T6 3/0,9kW (A6:3) (20°)	3	49,24	53,01	17.038,58	253,36	2,54	1440	1,00
HC 90 T4/T6 3/0,9kW (A6:3) (22°)	3	49,14	52,47	18.593,33	272,71	2,99	1440	1,00
HC 90 T4/T6 4/1,1kW (A6:3) (24°)	4	49,02	51,96	20.176,85	290,07	3,44	1430	1,00
HC 90 T4/T6 4/1,1kW (A6:3) (26°)	4	47,64	50,20	21.621,45	305,39	3,95	1430	1,00
HC 90 T4/T6 4/1,1kW (A6:3) (28°)	4	46,32	48,52	23.127,77	320,19	4,51	1430	1,00
HC 90 T4/T6 5,5/1,85kW (A6:3) (30°)	5,5	44,67	46,56	24.523,24	324,85	5,05	1450	1,00
HC 90 T4/T6 5,5/1,85kW (A6:3) (32°)	5,5	42,51	44,07	25.979,43	325,52	5,70	1450	1,00
HC 90 T4/T6 5,5/1,85kW (A6:6) (20°)	5,5	52,33	54,63	18.994,33	402,25	4,36	1450	1,00
HC 90 T4/T6 5,5/1,85kW (A6:6) (22°)	5,5	52,09	53,95	20.849,42	427,50	5,10	1450	1,00
HC 90 T4/T6 7,5/2,2kW (A6:3) (34°)	7,5	40,44	41,70	27.421,18	326,25	6,36	1450	1,00
HC 90 T4/T6 7,5/2,2kW (A6:3) (36°)	7,5	37,69	38,61	28.887,19	325,88	7,19	1450	1,00
HC 90 T4/T6 7,5/2,2kW (A6:6) (24°)	7,5	52,03	53,52	22.583,12	453,19	5,86	1450	1,00
HC 90 T4/T6 7,5/2,2kW (A6:6) (26°)	7,5	50,47	51,56	24.007,62	478,74	6,76	1450	1,00
HC 90 T4/T6 7,5/2,2kW (A6:6) (28°)	7,5	49,11	49,82	25.483,88	502,92	7,77	1450	1,00
HC 90 T4/T6 11/3,6kW (A6:3) (38°)	11	35,39	36	30.411,02	323,70	8,06	1430	1,00
HC 90 T4/T6 11/3,6kW (A6:6) (30°)	11	47,73	48,14	27.036,29	517,97	8,68	1430	1,00
HC 90 T4/T6 11/3,6kW (A6:6) (32°)	11	45,83	45,93	28.603,97	528,78	9,71	1430	1,00
HC 90 T4/T6 11/3,6kW (A6:6) (34°)	11	44,02	44,05	30.278,42	536,63	10,78	1430	1,00
HC 90 T4/T6 15/4,4kW (A6:6) (36°)	15	42,56	42,53	32.348,89	530,89	11,68	1420	1,00
HC 90 T4/T6 15/4,4kW (A6:6) (38°)	15	40,84	40,73	34.393,14	529,97	12,77	1420	1,00
HC 90 T4/T6 15/4,4kW (A6:6) (40°)	15	38,70	38,52	35.693,49	524,48	13,93	1420	1,00
HC 100 T4/T6 5,5/1,85kW (A6:3) (20°)	5,5	55,26	58,08	22.586,33	303,57	3,60	1450	1,00
HC 100 T4/T6 5,5/1,85kW (A6:3) (22°)	5,5	54,92	57,78	24.876,14	326,93	3,55	1450	1,00
HC 100 T4/T6 5,5/1,85kW (A6:3) (24°)	5,5	53,98	55,89	27.115,65	348	5,01	1450	1,00
HC 100 T4/T6 5,5/1,85kW (A6:3) (26°)	5,5	51,93	53,44	29.182,08	364,29	5,80	1450	1,00
HC 100 T4/T6 7,5/2,2kW (A6:3) (28°)	7,5	50,50	51,66	31.271,98	379,40	6,61	1450	1,00
HC 100 T4/T6 7,5/2,2kW (A6:3) (30°)	7,5	48,09	48,91	33.404,84	381,28	7,47	1450	1,00
HC 100 T4/T6 7,5/2,2kW (A6:6) (20°)	7,5	55,71	56,99	24.343,21	481,25	6,33	1450	1,00

Model	Mot. power (kW)	Maximum efficiency point data						
		Max. efficiency (%)	Efficiency grade (N)	Air Flow (m3/h)	Ps (Pa)	Pabs (kW)	Speed (rpm)	Specific Ratio
HC 100 T4/T6 7,5/2,2kW (A6:6) (22°)	7,5	55,67	56,47	27.135,33	513,68	7,53	1450	1,00
HC 100 T4/T6 11/3,6kW (A6:3) (32°)	11	46	46,52	35.700,53	378,41	8,34	1430	1,00
HC 100 T4/T6 11/3,6kW (A6:3) (34°)	11	42,98	43,16	37.709,85	376,65	9,43	1430	1,00
HC 100 T4/T6 11/3,6kW (A6:3) (36°)	11	40,08	40,13	39.152,83	372,58	10,53	1430	1,00
HC 100 T4/T6 11/3,6kW (A6:6) (24°)	11	55,82	56,24	29.855,14	541,52	8,67	1430	1,00
HC 100 T4/T6 11/3,6kW (A6:6) (26°)	11	55,05	55,13	32.630,11	557,41	9,78	1430	1,00
HC 100 T4/T6 11/3,6kW (A6:6) (28°)	11	53,63	53,63	35.488,84	574,93	11,11	1430	1,00
HC 100 T4/T6 15/4,4kW (A6:3) (38°)	15	37,57	37,54	40.656,41	369,08	11,69	1420	1,00
HC 100 T4/T6 15/4,4kW (A6:6) (30°)	15	51,97	51,88	38.100,43	584,23	12,47	1420	1,00
HC 100 T4/T6 15/4,4kW (A6:6) (32°)	15	50,07	49,90	40.698,13	591,56	13,95	1420	1,00
HC 100 T4/T6 18,5/6kW (A6:6) (34°)	18,5	48,12	47,86	43.258,41	598,12	15,55	1420	1,00
HC 100 T4/T6 18,5/6kW (A6:6) (36°)	18,5	45,61	45,26	45.749,12	601,46	17,37	1420	1,00
HC 100 T4/T6 22/7,5kW (A6:6) (38°)	22	43,50	43,08	48.316,64	603,86	19,22	1420	1,00
HC 100 T4/T6 22/7,5kW (A6:6) (40°)	22	41,11	40,62	50.228,34	595,14	20,96	1420	1,00
HC 112 T4/T6 5,5/1,85kW (A6:3) (20°)	5,5	52,66	54,65	27.306,06	330,01	4,88	1450	1,00
HC 112 T4/T6 5,5/1,85kW (A6:3) (22°)	5,5	54,25	55,76	30.997,21	358,03	5,82	1450	1,00
HC 112 T4/T6 7,5/2,2kW (A6:3) (24°)	7,5	54,90	55,97	34.623,10	381,96	6,82	1450	1,00
HC 112 T4/T6 7,5/2,2kW (A6:3) (26°)	7,5	53,05	53,66	38.016,12	397,60	8,05	1450	1,00
HC 112 T4/T6 11/3,6kW (A6:3) (28°)	11	51,95	52,16	41.611,52	412,38	9,32	1430	1,00
HC 112 T4/T6 11/3,6kW (A6:3) (30°)	11	49,77	49,81	44.242,32	420,80	10,58	1430	1,00
HC 112 T4/T6 11/3,6kW (A6:6) (20°)	11	54,88	55,27	30.082,65	539,13	8,72	1430	1,00
HC 112 T4/T6 11/3,6kW (A6:6) (22°)	11	55,93	55,99	34.046,39	574,11	10,34	1430	1,00
HC 112 T4/T6 15/4,4kW (A6:3) (32°)	15	47,99	47,94	46.861,26	428,16	11,84	1420	1,00
HC 112 T4/T6 15/4,4kW (A6:3) (34°)	15	45,05	44,90	49.204,26	432,78	13,44	1420	1,00
HC 112 T4/T6 15/4,4kW (A6:3) (36°)	15	42,11	41,87	51.227,83	432,64	15,09	1420	1,00
HC 112 T4/T6 15/4,4kW (A6:6) (24°)	15	56,68	56,62	37.975,26	606,49	12	1420	1,00
HC 112 T4/T6 15/4,4kW (A6:6) (26°)	15	56,60	56,43	42.073,29	625,95	13,77	1420	1,00
HC 112 T4/T6 15/4,4kW (A6:6) (28°)	15	56,36	56,09	46.246,85	646,55	15,69	1420	1,00
HC 112 T4/T6 18,5/6kW (A6:3) (38°)	18,5	39,21	38,89	53.213,23	431,91	16,92	1420	1,00
HC 112 T4/T6 18,5/6kW (A6:6) (30°)	18,5	55,23	54,87	49.777,71	670,80	17,71	1420	1,00
HC 112 T4/T6 22/7,5kW (A6:6) (32°)	22	54,11	53,66	53.425,81	693,47	19,83	1420	1,00
HC 112 T4/T6 22/7,5kW (A6:6) (34°)	22	52,42	51,89	56.927	709,72	22,10	1420	1,00
HC 125 T4/T6 11/3,6kW (A7:4) (20°)	11	50,56	50,75	36.598,97	451,89	9,42	1430	1,00
HC 125 T4/T6 11/3,6kW (A7:4) (22°)	11	52,76	52,77	41.381,22	490,92	11,07	1430	1,00
HC 125 T4/T6 15/4,4kW (A7:4) (24°)	15	54,08	53,97	46.299,44	524,29	12,87	1420	1,00
HC 125 T4/T6 15/4,4kW (A7:4) (26°)	15	53,91	53,68	51.353,96	552,14	15,01	1420	1,00
HC 125 T4/T6 15/4,4kW (A7:8) (20°)	15	52,26	51,99	39.157,13	716,62	15,77	1420	1,00
HC 125 T4/T6 18,5/6kW (A7:4) (28°)	18,5	53,91	53,56	56.643,01	578,72	17,27	1420	1,00

Model	Mot. power (kW)	Maximum efficiency point data						
		Max. efficiency (%)	Efficiency grade (N)	Air Flow (m3/h)	Ps (Pa)	Pabs (kW)	Speed (rpm)	Specific Ratio
HC 125 T4/T6 18,5/6kW (A7:4) (30°)	18,5	52,29	51,84	60.854,33	594,58	19,69	1420	1,00
HC 125 T4/T6 18,5/6kW (A7:8) (22°)	18,5	53,09	52,68	44.346,10	765,42	18,80	1420	1,00
HC 125 T4/T6 22/7,5kW (A7:4) (32°)	22	50,53	49,99	65.025,18	610,99	22,31	1420	1,00
HC 125 T4/T6 22/7,5kW (A7:8) (24°)	22	53,73	53,20	49.919,85	809,99	22,10	1420	1,00

ERP / 4/8 poles

Model	Mot. power (kW)	Maximum efficiency point data						
		Max. efficiency (%)	Efficiency grade (N)	Air Flow (m3/h)	Ps (Pa)	Pabs (kW)	Speed (rpm)	Specific Ratio
HC 45 T4/T8 0,33/0,04kW (A0:6) (40°)	0,33/0,04	27,90	36,87	4.031,59	88,07	0,38	1420	1,00
HC 50 T4/T8 0,55/0,09kW (A0:6) (40°)	0,55/0,09	34,91	42,59	5.600,18	134,36	0,61	1420	1,00
HC 56 T4/T8 0,33/0,04kW (A5:6) (20°)	0,33/0,04	39,16	47,30	4.450,98	158,25	0,52	1420	1,00
HC 56 T4/T8 0,55/0,09kW (A2:6) (20°)	0,55/0,09	38,89	47,20	4.044,51	159,60	0,48	1420	1,00
HC 56 T4/T8 0,55/0,09kW (A2:6) (25°)	0,55/0,09	38,90	46,29	5.079,11	177,41	0,68	1420	1,00
HC 56 T4/T8 0,55/0,09kW (A2:9) (20°)	0,55/0,09	37,73	45,06	4.058,71	213,78	0,69	1420	1,00
HC 56 T4/T8 0,55/0,09kW (A5:6) (25°)	0,55/0,09	40,67	48,26	5.579,79	156,10	0,63	1420	1,00
HC 56 T4/T8 0,75/0,12kW (A2:6) (27,5°)	0,75/0,12	43,99	51,28	5.734,45	186,22	0,71	1420	1,00
HC 56 T4/T8 0,75/0,12kW (A2:6) (30°)	0,75/0,12	43,09	50,15	6.025,67	189,79	0,77	1420	1,00
HC 56 T4/T8 0,75/0,12kW (A2:6) (32,5°)	0,75/0,12	41,28	47,96	6.535,55	193,03	0,88	1420	1,00
HC 56 T4/T8 0,75/0,12kW (A2:9) (25°)	0,75/0,12	44,82	51,79	5.157,47	228,92	0,79	1420	1,00
HC 56 T4/T8 0,75/0,12kW (A5:6) (30°)	0,75/0,12	40,86	47,99	7.150,49	147,76	0,75	1420	1,00
HC 56 T4/T8 0,75/0,12kW (A5:6) (32,5°)	0,75/0,12	42,61	49,42	6.724,10	173,51	0,84	1420	1,00
HC 56 T4/T8 1,1/0,18kW (A2:9) (27,5°)	1,1/0,18	45,64	52,18	5.992,84	236,38	0,92	1420	1,00
HC 56 T4/T8 1,1/0,18kW (A2:9) (30°)	1,1/0,18	44,95	51,27	6.352,21	239,91	1	1420	1,00
HC 56 T4/T8 1,1/0,18kW (A2:9) (32,5°)	1,1/0,18	43,48	49,50	6.869,63	242,32	1,12	1420	1,00
HC 56 T4/T8 1,1/0,18kW (A2:9) (35°)	1,1/0,18	42,11	47,86	7.380,42	245	1,24	1420	1,00
HC 56 T4/T8 1,1/0,18kW (A5:6) (35°)	1,1/0,18	39,49	46,01	7.592,48	167,07	0,93	1420	1,00
HC 56 T4/T8 1,1/0,18kW (A5:6) (37,5°)	1,1/0,18	38,19	44,24	8.313,94	173,66	1,11	1420	1,00
HC 56 T4/T8 1,5/0,25kW (A2:9) (37,5°)	1,5/0,25	41,07	46,57	7.899,82	243,19	1,35	1420	1,00
HC 56 T4/T8 1,5/0,25kW (A2:9) (40°)	1,5/0,25	39,25	44,49	8.409,63	242,60	1,49	1420	1,00
HC 56 T4/T8 1,5/0,25kW (A5:6) (40°)	1,5/0,25	37,56	43,20	9.053,32	177,82	1,28	1420	1,00
HC 63 T4/T8 0,55/0,09kW (A2:6) (20°)	0,55/0,09	40,93	48,54	5.260,91	166,30	0,63	1420	1,00
HC 63 T4/T8 0,75/0,12kW (A2:6) (25°)	0,75/0,12	47,89	54,87	6.888,27	187,16	0,79	1420	1,00
HC 63 T4/T8 0,75/0,12kW (A2:9) (20°)	0,75/0,12	47,89	54,70	5.526,55	241,34	0,84	1420	1,00
HC 63 T4/T8 0,75/0,12kW (A5:6) (25°)	0,75/0,12	48,90	55,52	7.749,60	190,49	0,90	1420	1,00
HC 63 T4/T8 1,1/0,18kW (A2:6) (27,5°)	1,1/0,18	49,29	55,79	7.966,26	201,05	0,94	1420	1,00

Model	Mot. power (kW)	Maximum efficiency point data						
		Max. efficiency (%)	Efficiency grade (N)	Air Flow (m3/h)	Ps (Pa)	Pabs (kW)	Speed (rpm)	Specific Ratio
HC 63 T4/T8 1,1/0,18kW (A2:6) (30°)	1,1/0,18	48,85	55,10	8.449,86	206,50	1,03	1420	1,00
HC 63 T4/T8 1,1/0,18kW (A2:6) (32,5°)	1,1/0,18	46,88	52,72	9.219,91	212,37	1,20	1420	1,00
HC 63 T4/T8 1,1/0,18kW (A2:9) (25°)	1,1/0,18	50,67	56,74	7.174,29	258,99	1,10	1420	1,00
HC 63 T4/T8 1,1/0,18kW (A2:9) (27,5°)	1,1/0,18	49,93	55,39	8.384,96	273,56	1,37	1420	1,00
HC 63 T4/T8 1,1/0,18kW (A5:6) (30°)	1,1/0,18	48,36	54,02	9.471,59	223,11	1,28	1420	1,00
HC 63 T4/T8 1,5/0,25kW (A2:6) (35°)	1,5/0,25	45,36	50,84	9.987,52	218,17	1,37	1420	1,00
HC 63 T4/T8 1,5/0,25kW (A2:6) (37,5°)	1,5/0,25	43,42	48,58	10.729,36	219,84	1,53	1420	1,00
HC 63 T4/T8 1,5/0,25kW (A2:6) (40°)	1,5/0,25	41,51	46,36	11.480,66	221,80	1,72	1420	1,00
HC 63 T4/T8 1,5/0,25kW (A2:9) (30°)	1,5/0,25	49,14	54,34	8.876,93	280,13	1,51	1420	1,00
HC 63 T4/T8 1,5/0,25kW (A2:9) (32,5°)	1,5/0,25	47,16	51,95	9.819,66	285,37	1,75	1420	1,00
HC 63 T4/T8 1,5/0,25kW (A5:6) (32,5°)	1,5/0,25	46,28	51,63	10.049,43	224,61	1,43	1420	1,00
HC 63 T4/T8 1,5/0,25kW (A5:6) (35°)	1,5/0,25	44,66	49,73	10.634,82	229,88	1,58	1420	1,00
HC 63 T4/T8 2,2/0,37kW (A2:9) (35°)	2,2/0,37	45,66	50,13	10.690,55	291,58	1,97	1420	1,00
HC 63 T4/T8 2,2/0,37kW (A2:9) (37,5°)	2,2/0,37	44,34	48,55	11.486,98	291,40	2,17	1420	1,00
HC 63 T4/T8 2,2/0,37kW (A2:9) (40°)	2,2/0,37	42,79	46,74	12.282,15	291,76	2,38	1420	1,00
HC 63 T4/T8 2,2/0,37kW (A2:9) (42,5°)	2,2/0,37	42,28	46,13	12.682,54	289,33	2,47	1420	1,00
HC 63 T4/T8 2,2/0,37kW (A5:6) (37,5°)	2,2/0,37	42,15	46,86	11.401	228,88	1,81	1420	1,00
HC 63 T4/T8 2,2/0,37kW (A5:6) (40°)	2,2/0,37	40,29	44,68	12.192,25	230,28	2,03	1420	1,00
HC 63 T4/T8 3/0,55kW (A2:9) (45°)	3/0,55	40,70	44,29	13.704,56	281,82	2,71	1420	1,00
HC 71 T4/T8 0,75/0,12kW (A2:6) (20°)	0,75/0,12	50,66	57,75	6.869,32	190,84	0,76	1420	1,00
HC 71 T4/T8 0,75/0,12kW (A5:6) (20°)	0,75/0,12	49,90	56,29	8.372,10	200,34	0,98	1420	1,00
HC 71 T4/T8 1,1/0,18kW (A2:6) (25°)	1,1/0,18	52,73	58,78	9.220,18	216,65	1,11	1420	1,00
HC 71 T4/T8 1,1/0,18kW (A2:9) (20°)	1,1/0,18	53,69	59,86	7.068,49	271,48	1,06	1420	1,00
HC 71 T4/T8 1,1/0,18kW (A5:6) (25°)	1,1/0,18	48,19	53,62	10.397,53	221,33	1,39	1420	1,00
HC 71 T4/T8 1,5/0,25kW (A2:6) (27,5°)	1,5/0,25	52,09	57,50	10.912,22	229,75	1,40	1420	1,00
HC 71 T4/T8 1,5/0,25kW (A2:6) (30°)	1,5/0,25	51	56,11	11.661,78	234,90	1,56	1420	1,00
HC 71 T4/T8 1,5/0,25kW (A2:6) (32,5°)	1,5/0,25	49,42	54,12	12.767,22	242,94	1,82	1420	1,00
HC 71 T4/T8 1,5/0,25kW (A2:9) (25°)	1,5/0,25	54,01	59,15	9.622,26	286,74	1,54	1420	1,00
HC 71 T4/T8 1,5/0,25kW (A5:6) (30°)	1,5/0,25	48,69	53,41	12.484,67	240,66	1,80	1420	1,00
HC 71 T4/T8 2,2/0,37kW (A2:6) (35°)	2,2/0,37	48,42	52,77	13.900,24	250,94	2,06	1420	1,00
HC 71 T4/T8 2,2/0,37kW (A2:6) (37,5°)	2,2/0,37	46,76	50,85	14.856,44	249,66	2,26	1420	1,00
HC 71 T4/T8 2,2/0,37kW (A2:6) (40°)	2,2/0,37	44,69	48,50	15.873,28	248,35	2,51	1420	1,00
HC 71 T4/T8 2,2/0,37kW (A2:9) (27,5°)	2,2/0,37	53,24	57,78	11.364,26	301,56	1,92	1420	1,00
HC 71 T4/T8 2,2/0,37kW (A2:9) (30°)	2,2/0,37	52,47	56,76	12.076,33	309,57	2,10	1420	1,00
HC 71 T4/T8 2,2/0,37kW (A2:9) (32,5°)	2,2/0,37	50,87	54,79	13.241,46	315,36	2,41	1420	1,00
HC 71 T4/T8 2,2/0,37kW (A5:6) (32,5°)	2,2/0,37	46,08	50,34	13.584,40	248,47	2,13	1420	1,00
HC 71 T4/T8 2,2/0,37kW (A5:6) (35°)	2,2/0,37	44,44	48,31	14.711,90	256,35	2,46	1420	1,00
HC 71 T4/T8 3/0,55kW (A2:6) (45°)	3/0,55	40,79	44,17	17.525,73	237,19	2,93	1420	1,00

Model	Mot. power (kW)	Maximum efficiency point data						
		Max. efficiency (%)	Efficiency grade (N)	Air Flow (m3/h)	Ps (Pa)	Pabs (kW)	Speed (rpm)	Specific Ratio
HC 71 T4/T8 3/0,55kW (A2:9) (35°)	3/0,55	49,76	53,34	14.476,09	320,58	2,73	1420	1,00
HC 71 T4/T8 3/0,55kW (A2:9) (37,5°)	3/0,55	47,86	51,12	15.671,19	322,48	3,07	1420	1,00
HC 71 T4/T8 3/0,55kW (A5:6) (37,5°)	3/0,55	42,73	46,36	15.385,79	256,45	2,67	1420	1,00
HC 71 T4/T8 3/0,55kW (A5:6) (40°)	3/0,55	41,28	44,71	16.071,79	257,98	2,89	1420	1,00
HC 80 T4/T8 1,1/0,18kW (A2:6) (20°)	1,1/0,18	54,76	61,15	8.717,96	212,26	0,98	1420	1,00
HC 80 T4/T8 1,5/0,25kW (A2:6) (25°)	1,5/0,25	55,12	60,30	12.084,38	236,27	1,52	1420	1,00
HC 80 T4/T8 1,5/0,25kW (A2:9) (20°)	1,5/0,25	54,96	60,20	9.312,63	298,57	1,49	1420	1,00
HC 80 T4/T8 2,2/0,37kW (A2:6) (27,5°)	2,2/0,37	55,24	59,75	14.418,13	254,06	1,94	1420	1,00
HC 80 T4/T8 2,2/0,37kW (A2:6) (30°)	2,2/0,37	54,26	58,46	15.422,24	262,37	2,18	1420	1,00
HC 80 T4/T8 2,2/0,37kW (A2:6) (32,5°)	2,2/0,37	52,93	56,72	16.968,83	270,13	2,53	1420	1,00
HC 80 T4/T8 2,2/0,37kW (A2:9) (25°)	2,2/0,37	55,64	59,77	12.722,75	323,27	2,24	1420	1,00
HC 80 T4/T8 3/0,55kW (A2:6) (35°)	3/0,55	52,33	55,77	18.524,04	278,91	2,88	1420	1,00
HC 80 T4/T8 3/0,55kW (A2:6) (37,5°)	3/0,55	49,42	52,48	20.023,66	281,83	3,30	1420	1,00
HC 80 T4/T8 3/0,55kW (A2:9) (27,5°)	3/0,55	55	58,54	15.084,16	335,23	2,77	1420	1,00
HC 80 T4/T8 3/0,55kW (A2:9) (30°)	3/0,55	54,50	57,80	16.131,69	341,20	3,03	1420	1,00
HC 80 T4/T8 3/0,55kW (A5:6) (30°)	3/0,55	55,68	59,36	17.060,33	297,05	2,63	1420	1,00
HC 80 T4/T8 3/0,55kW (A5:6) (32,5°)	3/0,55	52,36	55,66	18.296,01	296,87	3,02	1420	1,00
HC 80 T4/T8 3/0,55kW (A5:6) (35°)	3/0,55	49,80	52,77	19.560,26	299,70	3,41	1420	1,00
HC 80 T4/T8 4/0,75kW (A2:6) (40°)	4/0,75	46,89	49,62	21.482,19	284,61	3,72	1420	1,00
HC 80 T4/T8 4/0,75kW (A2:6) (42,5°)	4/0,75	44,72	47,25	22.250,17	282,99	4	1420	1,00
HC 80 T4/T8 4/0,75kW (A2:9) (32,5°)	4/0,75	51,81	54,64	17.915,03	349,60	3,60	1420	1,00
HC 80 T4/T8 4/0,75kW (A5:6) (37,5°)	4/0,75	48,62	51,28	21.096,99	306,23	3,82	1420	1,00
HC 80 T4/T8 4/0,75kW (A5:6) (40°)	4/0,75	47,80	50,18	22.715,02	308,46	4,22	1420	1,00
HC 80 T4/T8 5,5/1,1kW (A2:6) (45°)	5,5/1,1	40,21	42,30	24.071,60	277,60	4,69	1420	1,00
HC 80 T4/T8 5,5/1,1kW (A2:9) (35°)	5,5/1,1	48,42	50,73	19.784,99	357,65	4,32	1420	1,00
HC 80 T4/T8 5,5/1,1kW (A2:9) (37,5°)	5,5/1,1	47,48	49,53	21.293,55	364,53	4,77	1420	1,00
HC 80 T4/T8 5,5/1,1kW (A2:9) (40°)	5,5/1,1	46,29	48,05	22.877,51	371,99	5,31	1420	1,00
HC 90 T4/T8 3/0,55kW (A6:3) (20°)	3/0,55	49,24	53,01	17.038,58	253,36	2,54	1420	1,00
HC 90 T4/T8 3/0,55kW (A6:3) (22°)	3/0,55	49,14	52,47	18.593,33	272,71	2,99	1420	1,00
HC 90 T4/T8 4/0,75kW (A6:3) (24°)	4/0,75	49,02	51,96	20.176,85	290,07	3,44	1420	1,00
HC 90 T4/T8 4/0,75kW (A6:3) (26°)	4/0,75	47,64	50,20	21.621,45	305,39	3,95	1420	1,00
HC 90 T4/T8 4/0,75kW (A6:3) (28°)	4/0,75	46,32	48,52	23.127,77	320,19	4,51	1420	1,00
HC 90 T4/T8 5,5/1,1kW (A6:3) (30°)	5,5/1,1	44,67	46,56	24.523,24	324,85	5,05	1420	1,00
HC 90 T4/T8 5,5/1,1kW (A6:3) (32°)	5,5/1,1	42,51	44,07	25.979,43	325,52	5,70	1420	1,00
HC 90 T4/T8 5,5/1,1kW (A6:6) (20°)	5,5/1,1	52,33	54,63	18.994,33	402,25	4,36	1420	1,00
HC 90 T4/T8 5,5/1,1kW (A6:6) (22°)	5,5/1,1	52,09	53,95	20.849,42	427,50	5,10	1420	1,00
HC 90 T4/T8 7,5/1,5kW (A6:3) (34°)	7,5/1,5	40,44	41,70	27.421,18	326,25	6,36	1420	1,00
HC 90 T4/T8 7,5/1,5kW (A6:3) (36°)	7,5/1,5	37,69	38,61	28.887,19	325,88	7,19	1420	1,00

Model	Mot. power (kW)	Maximum efficiency point data						
		Max. efficiency (%)	Efficiency grade (N)	Air Flow (m3/h)	Ps (Pa)	Pabs (kW)	Speed (rpm)	Specific Ratio
HC 90 T4/T8 7,5/1,5kW (A6:6) (24°)	7,5/1,5	52,03	53,52	22.583,12	453,19	5,86	1420	1,00
HC 90 T4/T8 7,5/1,5kW (A6:6) (26°)	7,5/1,5	50,47	51,56	24.007,62	478,74	6,76	1420	1,00
HC 90 T4/T8 7,5/1,5kW (A6:6) (28°)	7,5/1,5	49,11	49,82	25.483,88	502,92	7,77	1420	1,00
HC 90 T4/T8 11/3kW (A6:6) (30°)	11/3	47,73	48,14	27.036,29	517,97	8,68	1420	1,00
HC 90 T4/T8 11/3kW (A6:6) (32°)	11/3	45,83	45,93	28.603,97	528,78	9,71	1420	1,00
HC 90 T4/T8 11/3kW (A6:6) (34°)	11/3	44,02	44,05	30.278,42	536,63	10,78	1420	1,00
HC 90 T4/T8 15/3,5kW (A6:6) (36°)	15/3,5	42,56	42,53	32.348,89	530,89	11,68	1420	1,00
HC 90 T4/T8 15/3,5kW (A6:6) (38°)	15/3,5	40,84	40,73	34.393,14	529,97	12,77	1420	1,00
HC 90 T4/T8 15/3,5kW (A6:6) (40°)	15/3,5	38,70	38,52	35.693,49	524,48	13,93	1420	1,00
HC 100 T4/T8 5,5/1,1kW (A6:3) (20°)	5,5/1,1	55,26	58,08	22.586,33	303,57	3,60	1420	1,00
HC 100 T4/T8 5,5/1,1kW (A6:3) (22°)	5,5/1,1	54,92	57,78	24.876,14	326,93	3,55	1420	1,00
HC 100 T4/T8 5,5/1,1kW (A6:3) (24°)	5,5/1,1	53,98	55,89	27.115,65	348	5,01	1420	1,00
HC 100 T4/T8 5,5/1,1kW (A6:3) (26°)	5,5/1,1	51,93	53,44	29.182,08	364,29	5,80	1420	1,00
HC 100 T4/T8 7,5/1,5kW (A6:3) (28°)	7,5/1,5	50,50	51,66	31.271,98	379,40	6,61	1420	1,00
HC 100 T4/T8 7,5/1,5kW (A6:3) (30°)	7,5/1,5	48,09	48,91	33.404,84	381,28	7,47	1420	1,00
HC 100 T4/T8 7,5/1,5kW (A6:6) (20°)	7,5/1,5	55,71	56,99	24.343,21	481,25	6,33	1420	1,00
HC 100 T4/T8 7,5/1,5kW (A6:6) (22°)	7,5/1,5	55,67	56,47	27.135,33	513,68	7,53	1420	1,00
HC 100 T4/T8 11/3kW (A6:3) (32°)	11/3	46	46,52	35.700,53	378,41	8,34	1420	1,00
HC 100 T4/T8 11/3kW (A6:3) (34°)	11/3	42,98	43,16	37.709,85	376,65	9,43	1420	1,00
HC 100 T4/T8 11/3kW (A6:3) (36°)	11/3	40,08	40,13	39.152,83	372,58	10,53	1420	1,00
HC 100 T4/T8 11/3kW (A6:6) (24°)	11/3	55,82	56,24	29.855,14	541,52	8,67	1420	1,00
HC 100 T4/T8 11/3kW (A6:6) (26°)	11/3	55,05	55,13	32.630,11	557,41	9,78	1420	1,00
HC 100 T4/T8 11/3kW (A6:6) (28°)	11/3	53,63	53,63	35.488,84	574,93	11,11	1420	1,00
HC 100 T4/T8 15/3,5kW (A6:6) (30°)	15/3,5	51,97	51,88	38.100,43	584,23	12,47	1420	1,00
HC 100 T4/T8 15/3,5kW (A6:6) (32°)	15/3,5	50,07	49,90	40.698,13	591,56	13,95	1420	1,00
HC 100 T4/T8 17/4,3kW (A6:6) (34°)	17/4,3	48,12	47,86	43.258,41	598,12	15,55	1420	1,00
HC 100 T4/T8 17/4,3kW (A6:6) (36°)	17/4,3	45,61	45,26	45.749,12	601,46	17,37	1420	1,00
HC 100 T4/T8 20/5kW (A6:6) (38°)	20/5	43,50	43,08	48.316,64	603,86	19,22	1420	1,00
HC 112 T4/T8 5,5/1,1kW (A6:3) (20°)	5,5/1,1	52,66	54,65	27.306,06	330,01	4,88	1420	1,00
HC 112 T4/T8 5,5/1,1kW (A6:3) (22°)	5,5/1,1	54,25	55,76	30.997,21	358,03	5,82	1420	1,00
HC 112 T4/T8 7,5/1,5kW (A6:3) (24°)	7,5/1,5	54,90	55,97	34.623,10	381,96	6,82	1420	1,00
HC 112 T4/T8 7,5/1,5kW (A6:3) (26°)	7,5/1,5	53,05	53,66	38.016,12	397,60	8,05	1420	1,00
HC 112 T4/T8 11/3kW (A6:3) (28°)	11/3	51,95	52,16	41.611,52	412,38	9,32	1420	1,00
HC 112 T4/T8 11/3kW (A6:3) (30°)	11/3	49,77	49,81	44.242,32	420,80	10,58	1420	1,00
HC 112 T4/T8 11/3kW (A6:6) (20°)	11/3	54,88	55,27	30.082,65	539,13	8,72	1420	1,00
HC 112 T4/T8 11/3kW (A6:6) (22°)	11/3	55,93	55,99	34.046,39	574,11	10,34	1420	1,00
HC 112 T4/T8 15/3,5kW (A6:3) (32°)	15/3,5	47,99	47,94	46.861,26	428,16	11,84	1420	1,00
HC 112 T4/T8 15/3,5kW (A6:3) (34°)	15/3,5	45,05	44,90	49.204,26	432,78	13,44	1420	1,00

Model	Mot. power (kW)	Maximum efficiency point data						
		Max. efficiency (%)	Efficiency grade (N)	Air Flow (m3/h)	Ps (Pa)	Pabs (kW)	Speed (rpm)	Specific Ratio
HC 112 T4/T8 15/3,5kW (A6:3) (36°)	15/3,5	42,11	41,87	51.227,83	432,64	15,09	1420	1,00
HC 112 T4/T8 15/3,5kW (A6:6) (24°)	15/3,5	56,68	56,62	37.975,26	606,49	12	1420	1,00
HC 112 T4/T8 15/3,5kW (A6:6) (26°)	15/3,5	56,60	56,43	42.073,29	625,95	13,77	1420	1,00
HC 112 T4/T8 15/3,5kW (A6:6) (28°)	15/3,5	56,36	56,09	46.246,85	646,55	15,69	1420	1,00
HC 112 T4/T8 17/4,3kW (A6:3) (38°)	17/4,3	39,21	38,89	53.213,23	431,91	16,92	1420	1,00
HC 112 T4/T8 17/4,3kW (A6:6) (30°)	17/4,3	55,23	54,87	49.777,71	670,80	17,71	1420	1,00
HC 112 T4/T8 20/5kW (A6:6) (32°)	20/5	54,11	53,66	53.425,81	693,47	19,83	1420	1,00
HC 112 T4/T8 28/6,5kW (A6:6) (34°)	28/6,5	52,42	51,89	56.927	709,72	22,10	1420	1,00
HC 112 T4/T8 28/6,5kW (A6:6) (36°)	28/6,5	50,27	49,65	60.259,07	714,30	24,46	1420	1,00
HC 112 T4/T8 28/6,5kW (A6:6) (38°)	28/6,5	47,93	47,23	63.563,76	719,57	27,13	1420	1,00
HC 112 T4/T8 35/8kW (A6:6) (40°)	35/8	45,08	44,31	66.879,03	709,13	29,95	1420	1,00
HC 125 T4/T8 11/3kW (A7:4) (22°)	11/3	52,76	52,77	41.381,22	490,92	11,07	1420	1,00
HC 125 T4/T8 15/3,5kW (A7:4) (24°)	15/3,5	54,08	53,97	46.299,44	524,29	12,87	1420	1,00
HC 125 T4/T8 15/3,5kW (A7:4) (26°)	15/3,5	53,91	53,68	51.353,96	552,14	15,01	1420	1,00
HC 125 T4/T8 15/3,5kW (A7:8) (20°)	15/3,5	52,26	51,99	39.157,13	716,62	15,77	1420	1,00
HC 125 T4/T8 17/4,3kW (A7:4) (28°)	17/4,3	53,91	53,56	56.643,01	578,72	17,27	1420	1,00
HC 125 T4/T8 20/5kW (A7:4) (30°)	20/5	52,29	51,84	60.854,33	594,58	19,69	1420	1,00
HC 125 T4/T8 20/5kW (A7:8) (22°)	20/5	53,09	52,68	44.346,10	765,42	18,80	1420	1,00
HC 125 T4/T8 28/6,5kW (A7:4) (32°)	28/6,5	50,53	49,99	65.025,18	610,99	22,31	1420	1,00
HC 125 T4/T8 28/6,5kW (A7:4) (34°)	28/6,5	48,16	47,52	68.749,63	620,53	25,10	1420	1,00
HC 125 T4/T8 28/6,5kW (A7:4) (36°)	28/6,5	45,11	44,38	72.444,23	614,48	28,19	1420	1,00
HC 125 T4/T8 28/6,5kW (A7:8) (24°)	28/6,5	53,73	53,20	49.919,85	809,99	22,10	1420	1,00
HC 125 T4/T8 28/6,5kW (A7:8) (26°)	28/6,5	54,82	54,18	56.057,61	847,78	25,48	1420	1,00
HC 125 T4/T8 35/8kW (A7:8) (28°)	35/8	55,29	54,54	62.225,48	888,81	29,39	1420	1,00
HC 125 T4/T8 35/8kW (A7:8) (30°)	35/8	54,34	53,49	67.473,87	910,36	33,08	1420	1,00
HC 125 T4/T8 37/9,2kW (A7:8) (32°)	37/9,2	53,08	52,14	72.689,59	929,84	37,24	1420	1,00
HC 125 T4/T8 44/11kW (A7:8) (34°)	44/11	51,54	50,52	77.693,38	950,51	41,53	1420	1,00