

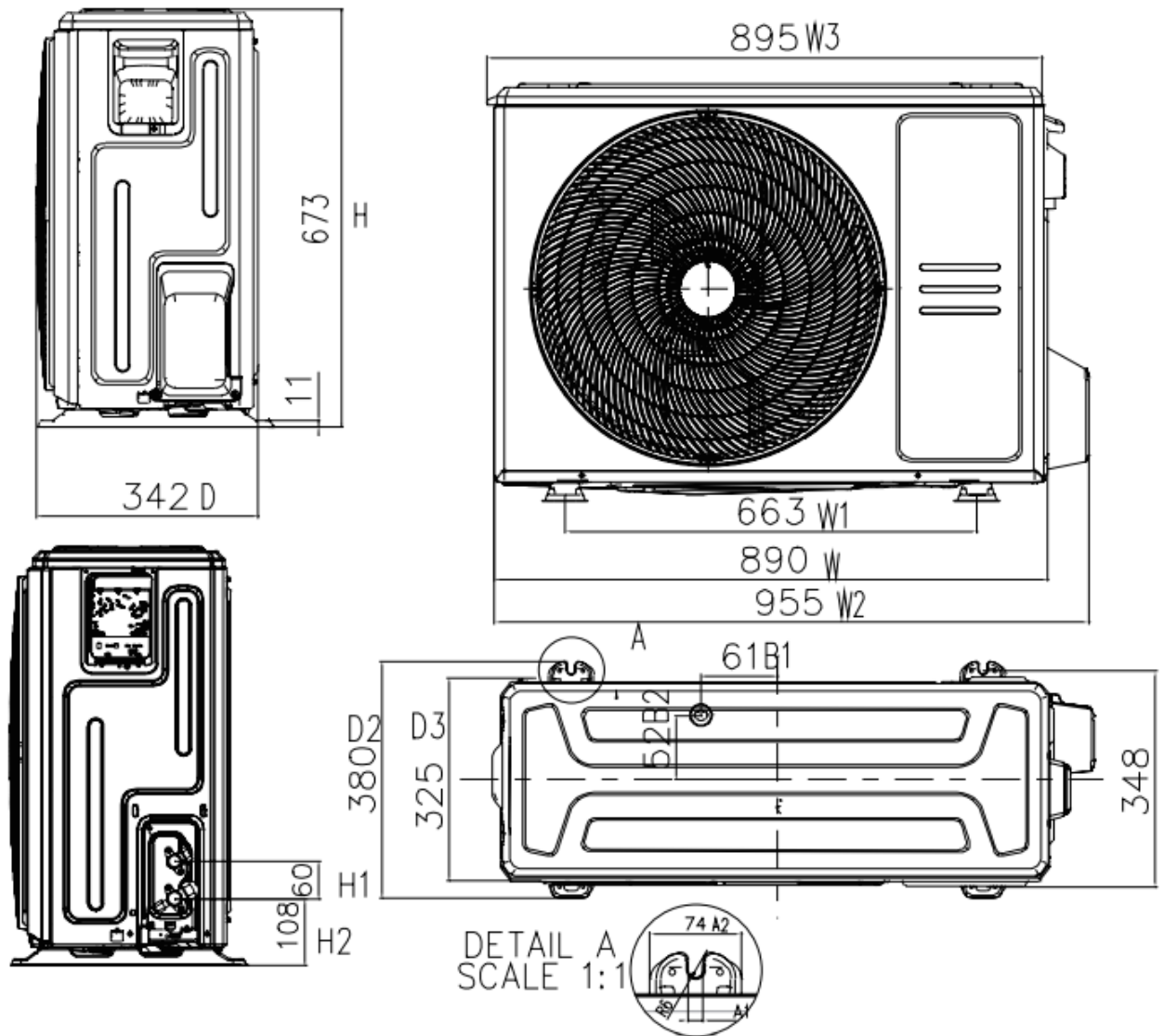

Capacity (kBtu/h)	unit	Outline Dimension				Air Outlet Opening Size		Air Return Opening Size		Size Of Mounted Lug		Fresh Air Intake Opening Size		Size of refrigerant pipe			
		A	B	C	D	E	F	G	H	I	J	K	L	H1	H2	W1	W2
ATI-53	mm	700	245	750	795	527	178	592	212	740	640	100	126	72	144	120	165
	inch	27.6	9.6	29.5	31.3	20.7	7.0	23.3	8.3	29.1	25.2	3.9	5.0	2.8	5.7	4.7	6.5
ATI-71	mm	1000	245	750	795	827	178	892	212	1040	640	100	126	80	151	120	165
	inch	39.4	9.6	29.5	31.3	32.6	7.0	35.1	8.3	40.9	25.2	3.9	5.0	3.1	5.9	4.7	6.5

Model:	
ATI-53_71HRDC1C	
Outline Dimensions Drawing	



Model:	
AOU-71HRDC1A	
Outline Dimensions Drawing	2