



Internal Use Only

<http://biz.lgservice.com>

# Air Conditioner

## SVC MANUAL(General)

### CAUTION

Before Servicing the unit, read the safety precautions in General SVC manual.  
Only for authorized service personnel.

# TABLE OF CONTENTS

<b>Part 1</b>	<b>General Information</b> .....	3
	1. Safety Precautions.....	4
	2. Model Line Up.....	7
	3. Nomenclature .....	10
<b>Part 2</b>	<b>Functions &amp; Controls</b> .....	14
	1. List of Functions & Accessory .....	15
	2. Air Flow .....	18
	3. Air Purifying.....	20
	4. Installation Functions .....	21
	5. Reliability .....	27
	6. Convenience Functions & Controls .....	28
	7. Special Function & KIT .....	36
<b>Part 3</b>	<b>Basic Control</b> .....	39
	1. Normal operation .....	40
	2 Compressor control .....	40
	3. EEV( Electronic Expansion Valve) control .....	40
<b>Part 4</b>	<b>Trouble Shooting Guide</b> .....	41
	1. Self-diagnosis Function .....	42
	2. Pump Down .....	44
	3. Evacuation (All amount of refrigerant leaked) .....	45
	4. Gas Charging (After Evacuation).....	46
	5. Cycle Part.....	47
	6. Electronic Parts.....	48

---



# Part 1 General Information

1. Safety Precautions .....	4
2. Model Line Up .....	7
3. Nomenclature.....	10



## 1. Safety Precautions

To prevent injury to the user or other people and property damage, the following instructions must be followed.







- Incorrect operation due to ignoring instruction will cause harm or damage. The seriousness is classified by the following indications.

 <b>WARNING</b>	This symbol indicates the possibility of death or serious injury.
 <b>CAUTION</b>	This symbol indicates the possibility of injury or damage to properties only.





- Meanings of symbols used in this manual are as shown below.







	<b>Be sure not to do.</b>
	<b>Be sure to follow the instruction.</b>
	<b>Dangerous Voltage</b>

### 1.1 Cautions in Repair





 <b>WARNING</b>	
Be sure to disconnect the power cable plug from the plug socket before disassembling the equipment for a repair. Internal components and circuit boards are at main potential when the equipment is connected to the power cables. This voltage is extremely dangerous and may cause death or severe injury if come in contact with it.	
Do not touch the discharging refrigerant gas during the repair work. The discharging refrigerant gas. The refrigerant gas can cause frostbite.	
Release the refrigerant gas completely at a well-ventilated place first. Otherwise, when the pipe is disconnected, refrigerant gas or refrigerating machine oil discharges and it Can cause injury.	
When the refrigerant gas leaks during work, execute ventilation. If the refrigerant gas touches to a fire, poisonous gas generates. A case of leakage of the refrigerant and the closed room full with gas is dangerous because a shortage of oxygen occurs. Be sure to execute ventilation.	
When removing the front panel or cabinet, execute short-circuit and discharge between high voltage capacitor terminals. If discharge is not executed, an electric shock is caused by high voltage resulted in a death or injury.	
Do not turn the air-conditioner ON or OFF by plugging or unplugging the power plug. There is risk of fire or electrical shock.	





Part 1 General Information

<p>Do not use a defective or underrated circuit breaker. Use the correctly rated breaker and fuse. Otherwise there is a risk of fire or electric shock.</p>	
<p>Install the panel and the cover of control box securely. Otherwise there is risk of fire or electric shock due to dust, water etc.</p>	
<p>Indoor/outdoor wiring connections must be secured tightly and the cable should be routed properly so that there is no force pulling the cable from the connection terminals. Improper or loose connections can cause heat generation or fire.</p>	
<p>Do not touch, operate, or repair the product with wet hands. Holding the plug by hand when taking out. Otherwise there is risk of electric shock or fire.</p>	
<p>Use a vacuum pump or Inert (nitrogen) gas when doing leakage test or air purge. Do not compress air or Oxygen and Do not use Flammable gases. Otherwise, it may cause fire or explosion. - There is the risk of death, injury, fire or explosion.</p>	

 <b>CAUTION</b>	
<p>Do not turn on the breaker under condition that front panel and cabinet are removed.</p>	
<p>Be sure to earth the air conditioner with an earthing conductor connected to the earthing terminal.</p>	
<p>Conduct repair works after checking that the refrigerating cycle section has cooled down sufficiently. Otherwise, working on the unit, the hot refrigerating cycle section can cause burns.</p>	
<p>Do not tilt the unit when removing panels. Otherwise, the water inside the unit can spill and wet floor.</p>	
<p>Do not use the welder in a well-ventilated place. Using the welder in an enclosed room can cause oxygen deficiency.</p>	
<p>Be sure to turn off power switch before connect or disconnect connector, or parts damage may be occurred.</p>	

## 1.2 Inspections after Repair

<b>⚠ WARNING</b>	
Check to see if the power cable plug is not dirty or loose. If the plug is dust or loose it can cause an electrical shock or fire.	
Do not use a joined power cable or extension cable, or share the same power outlet with other electrical appliances. otherwise, it can cause an electrical shock, excessive heat generation or fire.	
Do not insert hands or other objects through the air inlet or outlet while the product is operating. There are sharp and moving parts that could cause personal injury.	
Do not block the inlet or outlet of air flow. It may cause product failure	

<b>⚠ CAUTION</b>	
Check to see if the parts are mounted correctly and wires are connected. Improper installation and connections can cause an electric shock or an injury.	
Check the installation platform or frame has corroded. Corroded installation platform or frame can cause the unit to fall, resulting in injury.	
Be sure to check the earth wire is correctly connected.	
After the work has finished, be sure to do an insulation test to check the resistance is 2[Mohm] or more between the charge section and the non-charge metal section (Earth position). If the resistance value is low, a disaster such as a leak or electric shock is caused at user's side.	
Check the drainage of the indoor unit after the repair. If drainage is faulty the water to enter the room and wet floor.	

## 2. Model Line Up

### 2.1 Indoor units

Category		Chassis Name	Capacity Index [kW (kBTu/h)]											
			1.5 (5)	2.1 (7)	2.5 (9)	3.5 (12)	5.0 (18)	7.1 (24)	8.0 (30)	10.0 (36)	12.5 (42)	14.0 (48)	15.0 (60)	
Wall mounted	Libero-R	SB		AMNW07GRBL0 [MS07AQ NBO]	AMNW09GRBL0 [MS09AQ NBO]	AMNW12GRBL0 [MS12AQ NBO]								
		SC					AMNW18GRCL0 [MS18AQ NCO]	AMNW24GRCL0 [MS24AQ NCO]						
	Libero-E	SW	AMNW06GEWA0 [MS06SQ NNW0]	AMNW07GEWA0 [MS07SQ NNW0]										
		SB			AMNW09GEBA0 [MS09SQ NBO]	AMNW12GEBA0 [MS12SQ NBO]								
		SC					AMNW18GEC A0 [MS18SQ NCO]	AMNW24GEC A0 [MS24SQ NCO]						
ART COOL	SF			AMNH09GAF*1 [MA09AH* NF1]	AMNH12GAF*1 [MA12AH* NF1]									
ART COOL Mirror	SB		AMNW07GDB*0 [MS07AW* NBO]	AMNW09GDB*0 [MS09AW* NBO]	AMNW12GDB*0 [MS12AW* NBO]									
	SC					AMNW18GDC*0 [MS18AW* NCO]	AMNW24GDC*0 [MS24AW* NCO]							
Ceiling Cassette	1-Way	TU			AMNH09GTUC0 [MT09AH NU1]	AMNH12GTUC0 [MT11AH NU1]								
	4-Way	TR	AMNH05GTRA0 [MT06AH NRO]	AMNH07GTRA0 [MT08AH NRO]	ATNH09GRLE2 [CT09 NR2]	ATNH12GRLE2 [CT12 NR2]								
		TQ					ATNH18GQLE2 [CT18 NQ2]							
		TP						ATNH24GPLE2 [CT24 NP2]	ATNH30GPLE2 [UT30 NP2]					
		TN								ATNH36GNLE2 [UT36 NN2]				
		TM									ATNH42GMLE2 [UT42 NM2]	ATNH48GMLE2 [UT48 NM2]	ATNH60GMLE2 [UT60 NM2]	
Ceiling Concealed Duct	High Static Pressure	BH					ABNH18GHLA2 [CB18 NH2]	ABNH24GHLA2 [CB24 NH2]						
		BG						ABNH30GGLA2 [UB30 NG2]	ABNH36GGLA2 [UB36 NG2]					
		BR								ABNH42GRLA2 [UB42 NR2]	ABNH48GRLA2 [UB48 NR2]	ABNH60GRLA2 [UB60 NR2]		
	Low Static Pressure (Slim)	B1			AMNH09GB1A2 [MB09AHL N13]	AMNH12GB1A2 [MB12AHL N13]								
		B2					AMNH18GB2A2 [MB18AHL N23]	AMNH24GB2A2 [MB24AHL N23]						
Ceiling & Floor	VE			AVNH09GELA2 [CV09 NE2]	AVNH12GELA2 [CV12 NE2]									
Ceiling Suspended	VJ					UVNH18GJLA2 [CV18 NJ2]	UVNH24GJLA2 [CV24 NJ2]	UVNH30GJLA2 [UV30 NJ2]						
	VK								UVNH36GKLA2 [UV36 NK2]					
	VL									UVNH42GLLA2 [UV42 NL2]	UVNH48GLLA2 [UV48 NL2]	UVNH60GLLA2 [UV60 NL2]		
Console	QA			AQNH09GALA0 [CQ09 NAO]	AQNH24GALA0 [CQ12 NAO]	AQNH18GALA0 [CQ18 NAO]								

**Notes :**

1. Refer the Combination Table of Product Data Book for Outdoor Units.
  - : connectable with Multi type outdoor units.
  - : connectable with Single CAC outdoor units..

2. \* indicates color of panel.

- ART COOL : Silver(V), Gold(G), White Silver(H), Red(E), Gallery(1)
- ART COOL Mirror : Mirror(R), Silver(V), White(W)

<p>• Wall Mounted(LIBERO-R)</p> <p>AMNW07GRBL0 [MS07AQ NB0]            AMNW09GRBL0 [MS09AQ NB0]            AMNW12GRBL0 [MS12AQ NB0]            AMNW18GRCL0 [MS18AQ NC0]            AMNW24GRCL0 [MS24AQ NC0]</p> 	<p>• ART COOL Mirror</p> <p>AMNW07GDB*0 [MS07AW* NB0]            AMNW09GDB*0 [MS09AW* NB0]            AMNW12GDB*0 [MS12AW* NB0]            AMNW18GDC*0 [MS18AW* NC0]            AMNW24GDC*0 [MS24AW* NC0]</p>  <p>* : Mirror(R), Silver(V), White(W)</p>
<p>• Wall Mounted(LIBERO-E)</p> <p>AMNW05GEWA0 [MS05SQ NW0]            AMNW07GEWA0 [MS07SQ NW0]            AMNW09GEBA0 [MS09SQ NB0]            AMNW12GEBA0 [MS12SQ NB0]            AMNW18GECA0 [MS18SQ NC0]            AMNW24GECA0 [MS24SQ NC0]</p> 	<p>• Ceiling Concealed Duct – High static pressure</p> <p>ABNH18GHLA2 [CB18 NH2]            ABNH24GHLA2 [CB24 NH2]            ABNH30GGLA2 [UB30 NG2]            ABNH36GGLA2 [UB36 NG2]            ABNH42GRLA2 [UB42 NR2]            ABNH48GRLA2 [UB48 NR2]            ABNH60GRLA2 [UB60 NR2]</p> 
<p>• ART COOL</p> <p>AMNH09GAF*1 [MA09AH* NF1]            AMNH12GAF*1 [MA12AH* NF1]</p>   <p>* : Silver(V), Gold(G), White Silver(H), Red(E), Gallery(1)</p>	<p>• Ceiling Concealed Duct – Low static pressure</p> <p>AMNH09GB1A2 [MB09AHL N13]            AMNH12GB1A2 [MB12AHL N13]            AMNH18GB2A2 [MB18AHL N23]            AMNH24GB2A2 [MB24AHL N23]</p> 
<p>• Ceiling Cassette 1-way</p> <p>AMNH09GTUC0 [MT09AH NU1]            AMNH12GTUC0 [MT11AH NU1]</p> 	<p>• Ceiling &amp; Floor</p> <p>AVNH09GELA2 [CV09 NE2]            AVNH12GELA2 [CV12 NE2]</p>  <p>• Ceiling Suspended</p> <p>UVNH18GJLA2 [CV18 NJ2]            UVNH24GJLA2 [CV24 NJ2]            UVNH30GJLA2 [UV30 NJ2]            UVNH36GKLA2 [UV36 NK2]            UVNH42GLLA2 [UV42 NL2]            UVNH48GLLA2 [UV48 NL2]            UVNH60GLLA2 [UV60 NL2]</p> 
<p>• Ceiling Cassette 4-way</p> <p>AMNH05GTRA0 [MT06AH NR0]            AMNH07GTRA0 [MT08AH NR0]            ATNH09GRLE2 [CT09 NR2]            ATNH12GRLE2 [CT12 NR2]            ATNH18GQLE2 [CT18 NQ2]            ATNH24GPLE2 [CT24 NP2]            ATNH30GPLE2 [UT30 NP2]            ATNH36GNLE2 [UT36 NN2]            ATNH42GMLE2 [UT42 NM2]            ATNH48GMLE2 [UT48 NM2]            ATNH60GMLE2 [UT60 NM2]</p> 	<p>• Console</p> <p>AQNH09GALA0 [CQ09 NA0]            AQNH12GALA0 [CQ12 NA0]            AQNH18GALA0 [CQ18 NA0]</p> 



## 2.2 Outdoor units

DC Inverter	AUUW368D2 [UU37W UO2]		
No. of connectable indoor units	1		
Total capacity index of connectable indoor units(kW)	10.0		
Power supply	3Ø, 380 - 415V, 50Hz		
Chassis			

DC Inverter	AUUW428D2 [UU43W U32]	AUUW488D2 [UU49W U32]	AUUW608D2 [UU61W U32]
No. of connectable indoor units	1 ~ 4		
Total capacity index of connectable indoor units(kW)	12.5	14.0	15.0
Power supply	3Ø, 380 - 415V, 50Hz		
Chassis			

### 3. Nomenclature

#### 3.1 Indoor Unit(Global)

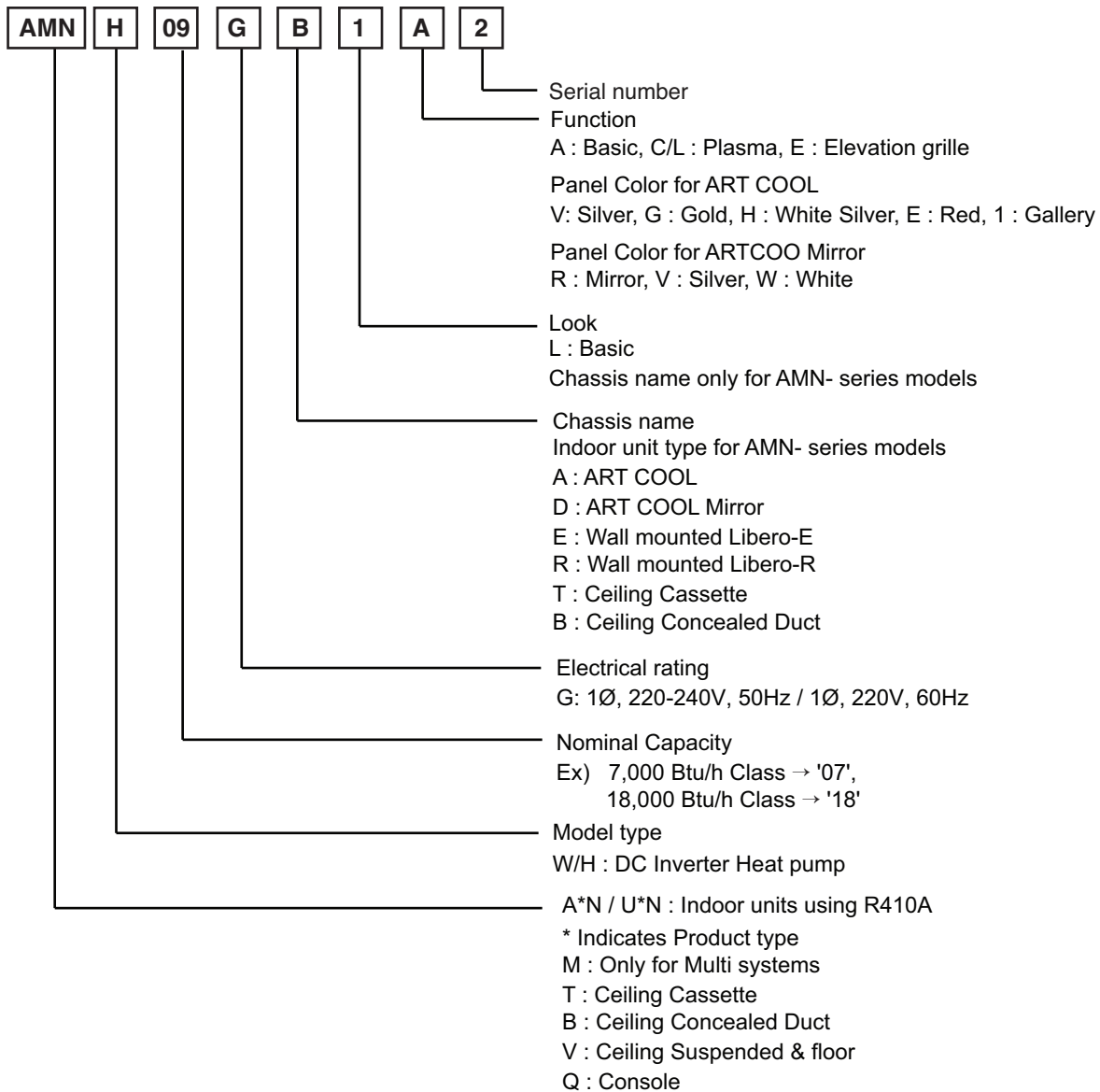

#### 3.2 Decoration panel(For ceiling cassette models)

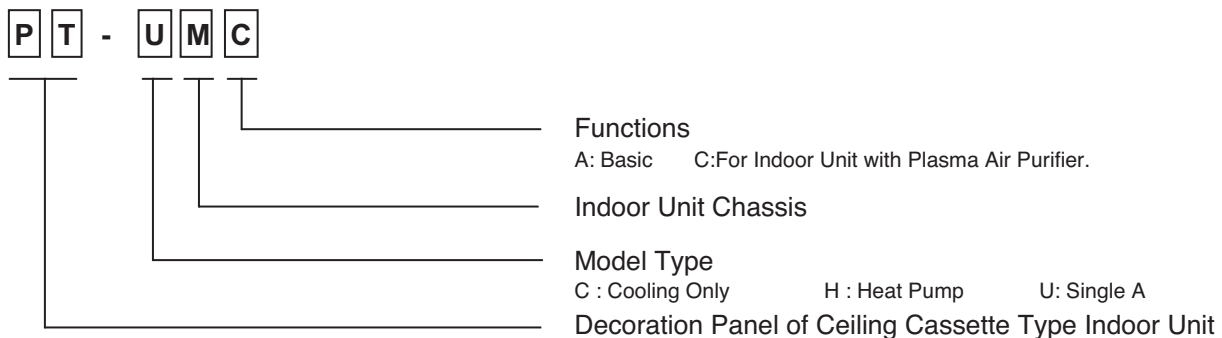

### 3.3 Outdoor Unit(Global)

A U U W 2 4 6 D 2

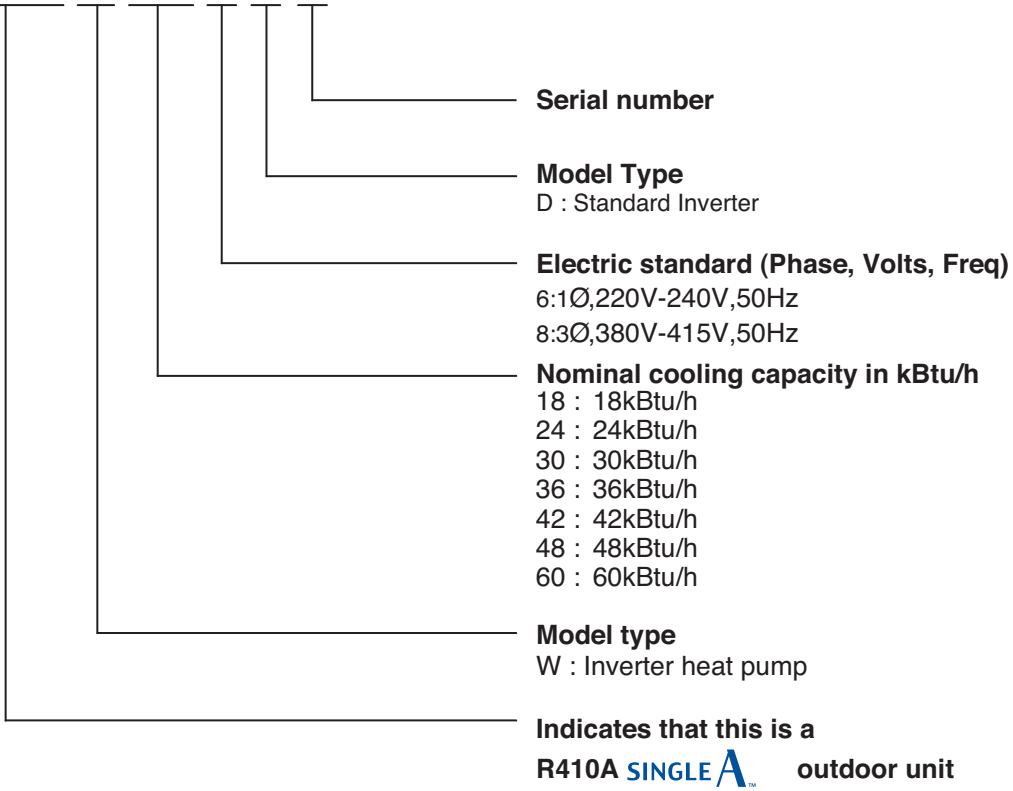

### 3.4 Indoor Unit(Europe)

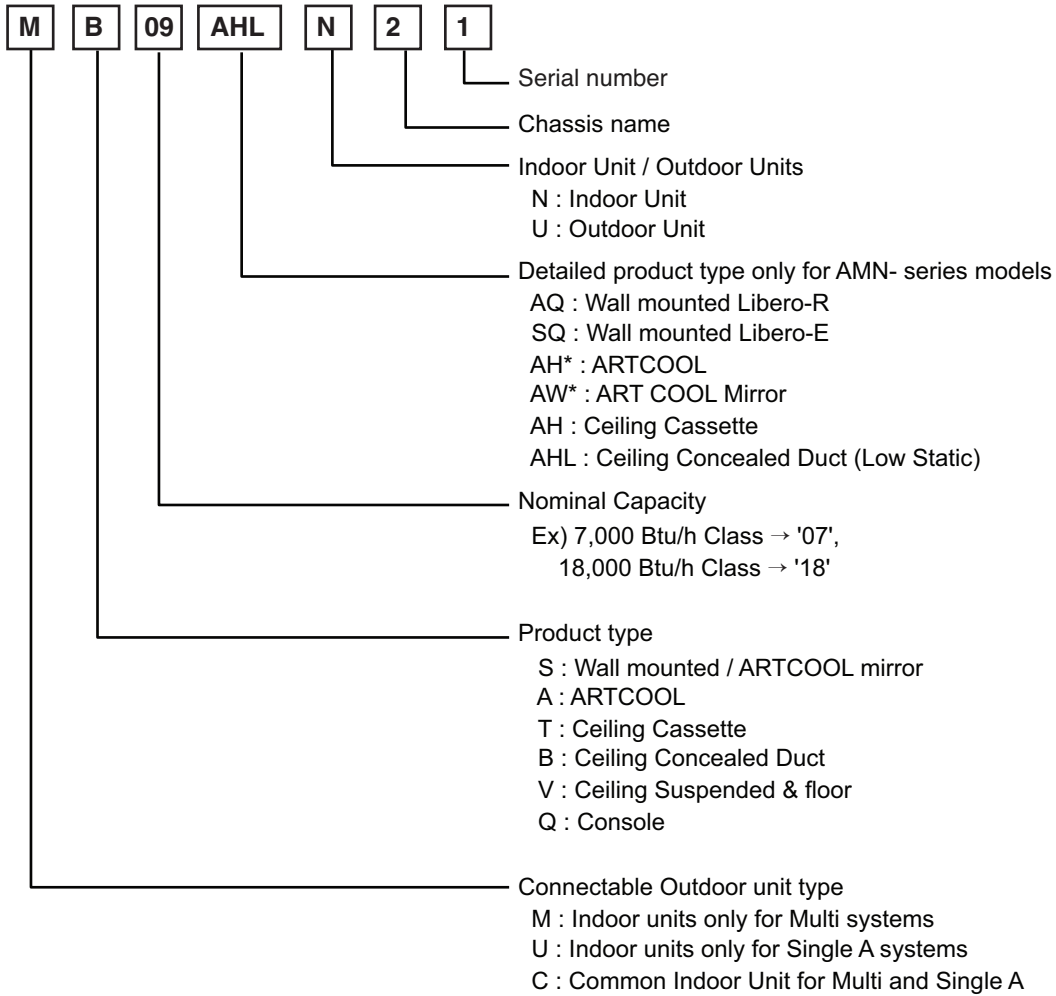

### 3.5 Decoration panel(For ceiling cassette models)

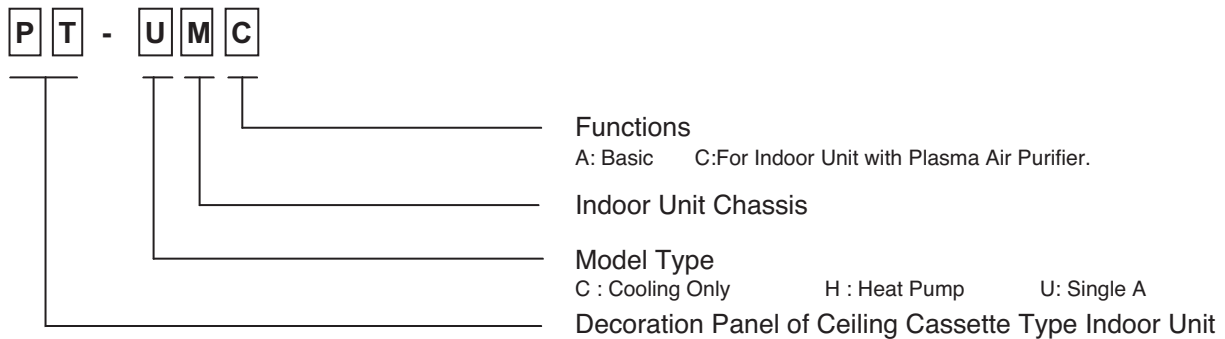

U U 2 4 W U4 2

### 3.6 Outdoor Unit(Europe)

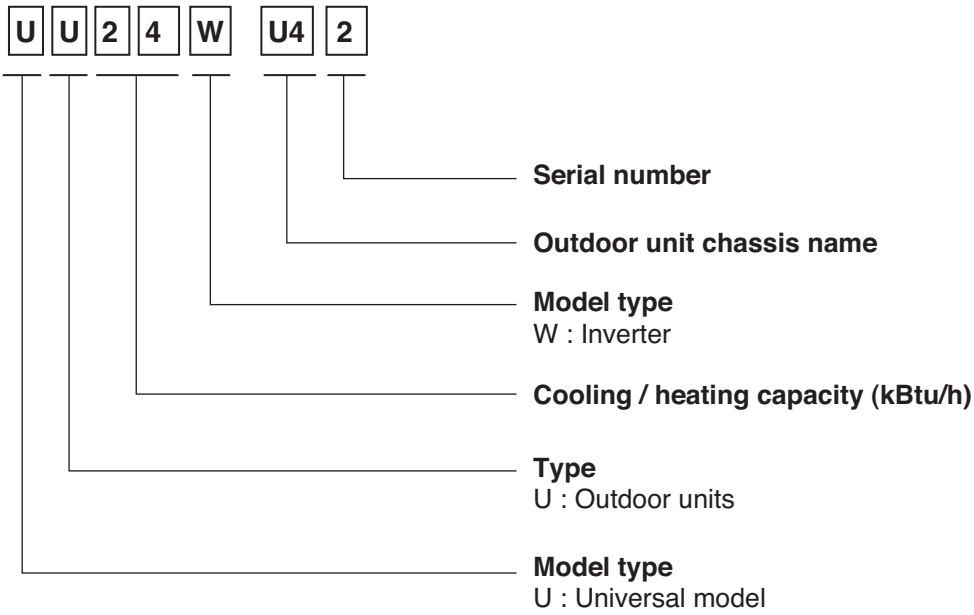

# Part 2 Functions & Controls

<b>1. List of Functions &amp; Accessory</b> .....	15
<b>2. Air flow</b> .....	18
2.1 Auto swing (left & right) .....	18
2.2 Auto swing (up & down) .....	18
2.3 Chaos swing (up/down).....	18
2.4 Air flow step.....	19
2.5 Chaos wind (auto wind).....	19
2.6 Jet Cool Mode Operation .....	19
2.7 Swirl wind Swing .....	19
<b>3. Air purifying</b> .....	20
3.1 PLASMA Air Purifying System .....	20
<b>4. Installation Functions</b> .....	21
4.1 E.S.P. (External Static Pressure) Setting .....	21
4.2 High Ceiling operation.....	26
<b>5. Reliability</b> .....	27
5.1 Hot start.....	27
5.2 Self-diagnosis Function.....	27
5.3 Soft dry operation.....	27
<b>6. Convenience Functions &amp; Controls</b> .....	28
6.1 Cooling & heating Operations .....	28
6.2 Auto cleaning operation .....	29
6.3 Auto changeover operation.....	29
6.4 Auto restart Opeartion.....	29
6.5 Child Lock Function.....	30
6.6 Forced operation .....	30
6.7 Group Control.....	31
6.8 Sleep Timer Operation .....	32
6.9 Timer(On/Off) .....	32
6.10 Weekly Program.....	33
6.11 Two Thermistor Control .....	35
<b>7. Special Function &amp; KIT</b> .....	36
7.1 Low Ambient control.....	36
7.2 Space Control .....	36
7.3 Auto Elevation Grille.....	36

## 1. List of Functions & Accessory

### 1. 4-Way Ceiling Cassette Indoor

Category	Function	Remark
Air flow	Air supply outlet	4
	Airflow direction control(left & right)	-
	Airflow direction control(up & down)	Auto
	Auto swing(left & right)	X
	Auto swing(up & down)	O
	Airflow steps(fan/cool/heat)	4 / 5 / 4
	Chaos swing	X
	Chaos wind(auto wind)	-
	Jet cool(Power wind)	O
	Swirl wind	O
Air purifying	Deodorizing filter	-
	Plasma air purifier	PTPKM0
	Prefilter(washable / anti-fungus)	O
Installation	Drain pump	O
	E.S.P. control	O
	Electric heater(operation)	-
	High ceiling operation	O
Reliability	Hot start	O
	Self diagnosis	O
	Soft dry operation	O
Convenience	Auto changeover	O
	Auto cleaning	X
	Auto operation(artificial intelligence)	X
	Auto restart operation	O
	Child lock	O
	Forced operation	O
	Group control	O
	Sleep mode	O
	Timer(on/off)	O
	Timer(weekly)	O
Two thermistor control	O	
Individual control	Standard wired remote controller	PCRCUSZ0
	Picto wired remote controller	PQRCUSA1
	Deluxe wired remote controller	PQRCUDS0
	Simple wired remote controller	PQRCUCA0
	Wired remote controller(for hotel use)	PQRCFCS0
	Wireless remote controller(simple)	X
	Wireless LCD remote control	PQWRHSF0(H/P) PQWRHDF0(H/P)
CAC network function	General central controller (Non LGAP)	X
	Dry contact	PQDSB
	Network Solution(LGAP)	O
	PDI(power distribution indicator)	X
	PI 485	PSNFP14A0
Special function kit	Zone control	X
	CTIE	X
	Electro thermostat	X
Others	Thermistor	-
	Home net Support	-

## 2. Ceiling Concealed Duct Indoor

Category	Function	Remark
Air flow	Air supply outlet	1
	Airflow direction control(left & right)	X
	Airflow direction control(up & down)	X
	Auto swing(left & right)	X
	Auto swing(up & down)	X
	Airflow steps(fan/cool/heat)	3/3/3
	Chaos swing	X
	Chaos wind(auto wind)	X
	Jet cool(Power wind)	X
	Swirl wind	X
Air purifying	Deodorizing filter	X
	Plasma air purifier	X
	Prefilter(washable / anti-fungus)	O
Installation	Drain pump	O
	E.S.P. control	O
	Electric heater(operation)	X
	High ceiling operation	X
Reliability	Hot start	O
	Self diagnosis	O
	Soft dry operation	O
Convenience	Auto changeover	O
	Auto cleaning	X
	Auto operation(artificial intelligence)	X
	Auto restart operation	O
	Child lock	O
	Forced operation	X
	Group control	O
	Sleep mode	X
	Timer(on/off)	O
	Timer(weekly)	O
	Two thermistor control	O
Individual control	Standard wired remote controller	X
	Picto wired remote controller	O(PQRCUSA0)
	Deluxe wired remote controller	X
	Simple wired remote controller	X
	Wired remote controller(for hotel use)	X
	Wireless remote controller(simple)	X
	Wireless LCD remote control	PQWRHSF0
CAC network function	General central controller (Non LGAP)	X
	Dry contact	PQDSB**
	Network Solution(LGAP)	O
	PDI(power distribution indicator)	PQNUD1S00
	PI 485	PMNFP14A0
Special function kit	Zone control	ABZCA
	CTIE	X
	Electro thermostat	X
Others	Thermistor	PQRSTA0



### 3. Ceiling & floor

Category	Functions	Remark
Air flow	Air supply outlet	1
	Airflow direction control (left & right)	Auto
	Airflow direction control (up & down)	Auto
	Auto swing (left & right)	O
	Auto swing (up & down)	O
	Airflow steps (fan/cool/heat)	5 / 6 / 6
	Chaos wind(auto wind)	O
	Jet cool/heat	O / O
Air purifying	Swirl wind	X
	Triple filter (Deodorizing)	O
	Plasma air purifier	O
	Allergy Safe filter	O
Installation	Long-life prefilter (washable / anti-fungus)	O
	Drain pump	X
	E.S.P. control	X
	Electric heater	X
Reliability	High ceiling operation	X
	Auto Elevation Grille	X
	Hot start	O
	Self diagnosis	O
Convenience	Soft dry operation	O
	Auto changeover	X
	Auto cleaning	O
	Auto operation(artificial intelligence)	O
	Auto Restart	O
	Child lock	X
	Forced operation	O
	Group control	X
	Sleep mode	O
	Timer(on/off)	O
Timer(weekly)	X	
Individual controller	Two thermistor control	X
	Wired remote controller	PQRCVSL0/PQRCVSLQW
	Deluxe wired remote controller	X
	Simple wired remote controller	X
	Simple Wired remote controller(for hotel use)	X
Network Solution	Wireless remote controller	O
	General central controller (Non LGAP)	X
	Network Solution(LGAP)	O
Special function kit	Dry contact	PQDSA(1)/PQDSB(1) / PQDSBC
	PI 485(for Indoor Unit)	X
	Zone controller	X
Others	CTI(Communication transfer interface)	X
	Electronic thermostat	X
Others	Remote temperature sensor	X
	Telecom shelter controller	X

### 4. Outdoor

Category	Function	Remark
Reliability	Defrost / Deicing	O
	Restart Delay (3-minutes)	O
	Self Diagnosis	O
	soft start	O
	Test Function	O
Convenience	Auto changeover	O
	Night Mode	O
	Auto Restart Operation	O
CAC network function	Central control(LGAP)	O
	Dry contact	PQDSB
	PDI(Power Distribution Indicator)	PQNUD1S00
	PI485	PMNFP14A0
Special function kit	Low Ambient Kit	O (program logic)

## 2. Air flow

### 2.1 Auto swing (left & right)

- By the horizontal airflow direction control key input, the left/right louver automatically operates with the auto swing or it is fixed to the desired direction.

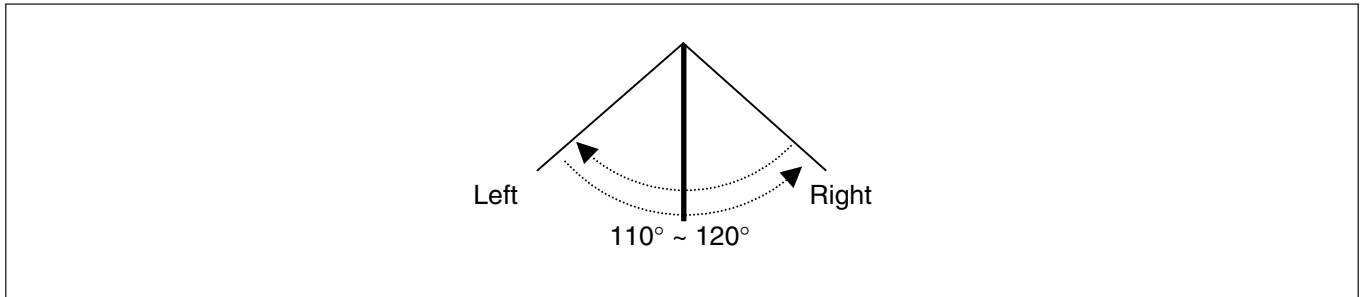

### 2.2 Auto swing (up & down)

- By the auto swing key input, the upper/lower vane automatically operates with the auto swing or it is fixed to the desired direction.

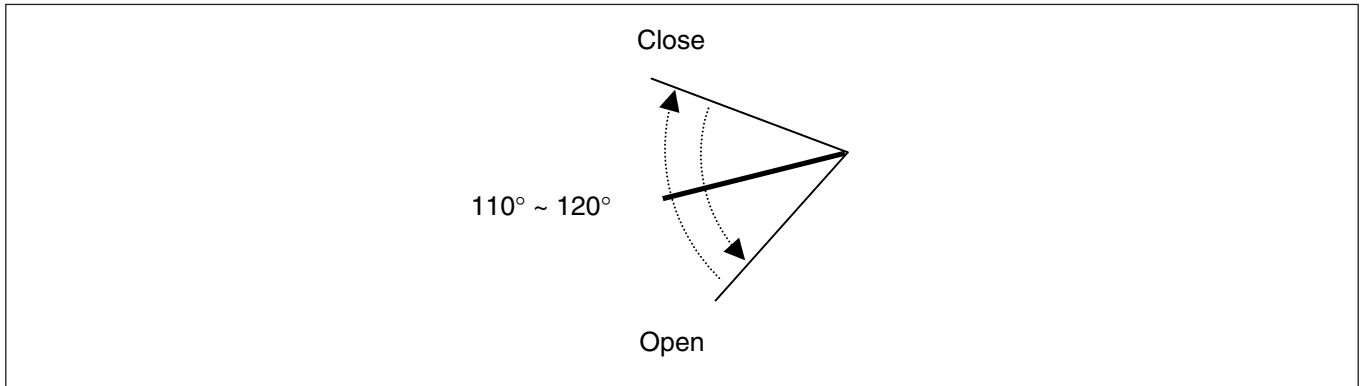

### 2.3 Chaos swing (up/down)

- By the Chaos swing key input, the upper/lower vane automatically operates with the chaos swing or it is fixed to the desired direction.

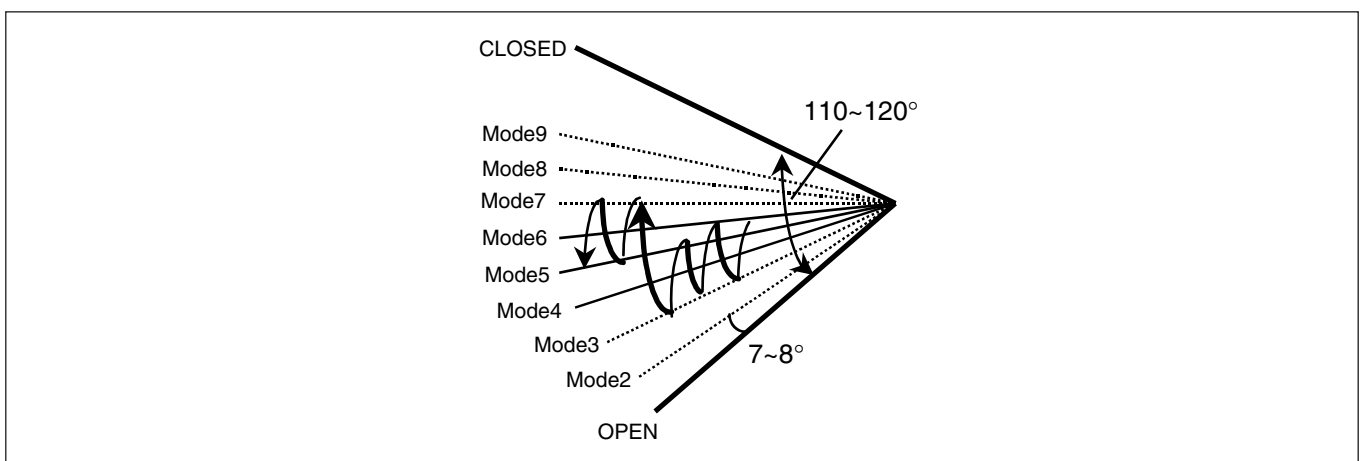

**NOTE:** Some Models are different by swing width and swing pattern.

## 2.4 Air flow step

- Indoor fan motor control have 6 steps.
- Air volume is controlled "SH", "H", "Med", "Low" by remote controller.
- "LL" step is selected automatically in Hot start operation.

Step	Discription
LL	Very low, In heating mode
L	Low
M	Med
H	High
SH	Super high
Auto	Chaos wind

## 2.5 Chaos wind (auto wind)

- When "Auto" step selected and then operated, the high, medium, or low speed of the airflow mode is operated for 2~15 sec. randomly by the Chaos Simulation

## 2.6 Jet Cool Mode Operation

- While in heating mode or Fuzzy operation, the Jet Cool key cannot be input. When it is input while in the other mode operation (cooling, dehumidification, ventilation), the Jet Cool mode is operated.
- In the Jet Cool mode, the indoor fan is operated at super-high speed for 30 min. at cooling mode operation.
- In the Jet Cool mode operation, the room temperature is controlled to the setting temperature, 18°C.
- When the sleep timer mode is input while in the Jet Cool mode operation, the Jet Cool mode has the priority.
- When the Jet Cool key is input, the upper/lower vanes are reset to those of the initial cooling mode and then operated in order that the air outflow could reach further.

## 2.7 Swirl wind Swing

- It is the function for comfort cooling/heating operation.
- The diagonal two louvers are opened the more larger than the other louvers. After one minute, it is opposite.

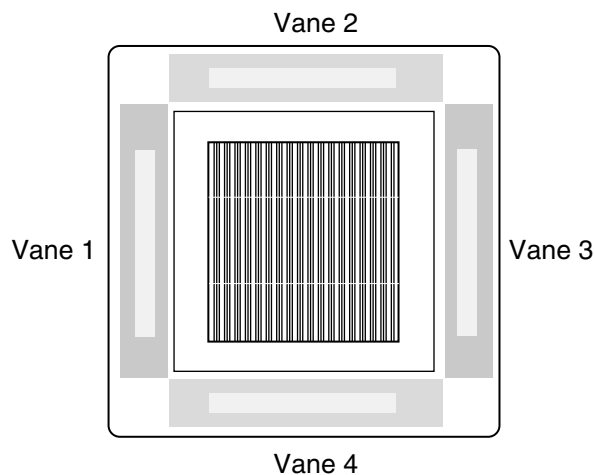

- Comparison of Air Flow Types

4-Open (conventional)

Vane 1	Open				
Vane 2	Open				
Vane 3	Open				
Vane 4	Open				
	Time				

Swirl Swing (New)

Vane 1	Close	Open	Close	Open	Close
Vane 2	Open	Close	Open	Close	Open
Vane 3	Close	Open	Close	Open	Close
Vane 4	Open	Close	Open	Close	Open
	Time				

### 3. Air purifying

#### 3.1 PLASMA Air Purifying System

The PLASMA Air Purifying System not only removes microscopic contaminants and dust, but also removes house mites, pollen, and pet fur to help prevent allergic diseases like asthma. This filter that can be used over and over again by simply washing with water.

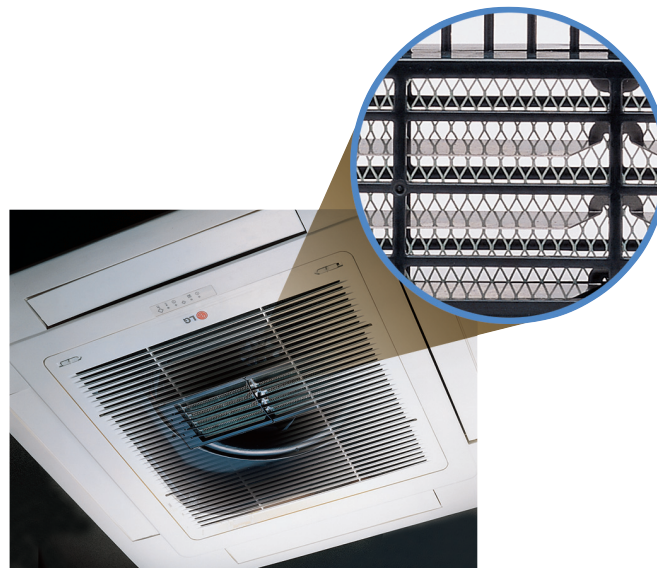
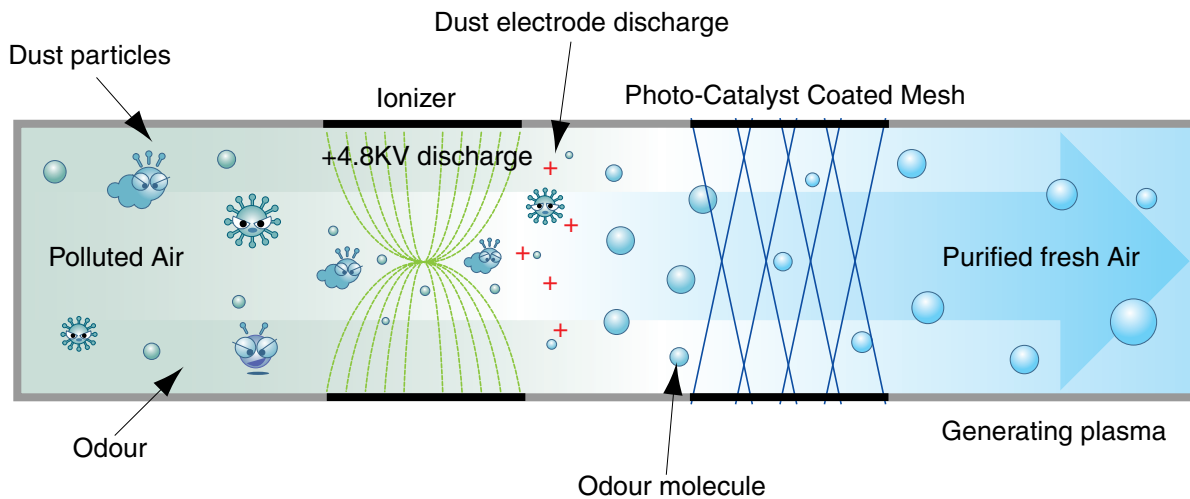

## 4. Installation Functions

### 4.1 E.S.P. (External Static Pressure) Setting

This function is applied to only duct type. Setting this in other cases will cause malfunction.

- 1** Press button for 4 seconds to enter the installer setting mode until timer segment displays "01:01".
- 2** If pressing button repeatedly, it moves to static pressure selection menu as picture below.
- 3** Select static pressure by pressing button.  
(01:V-H, 02:F-H, 03:V-L, 04:F-L)
- 4** Press button to save.
- 5** Pressing button will exit settings mode.  
\* After setup, it automatically gets out of setup mode if there is no button input for 25 seconds.  
\* When exiting without pressing set button, the manipulated value is not reflected.

<Static Pressure Setting Table>

Pressure selection		Function	
		Zone state	ESP standard value
01	V-H	Variable	High
02	F-H	Fixed	High
03	V-L	Variable	Low
04	F-L	Fixed	Low

This is the function that decides the strength of the wind for each wind level and because this function is to make the installation easier.

- If you set ESP incorrectly, the air conditioner may malfunction.
- This setting must be carried out by a certificated-technician.

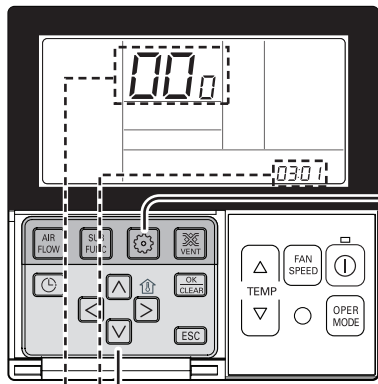

**1** If pressing button long for 3 seconds, it enters into remote controller setter setup mode.  
- If pressing once shortly, it enters into user setup mode.  
Please press more than 3 seconds for sure.

**2** If entering into ESP setup mode by using button, it indicates as the picture below.

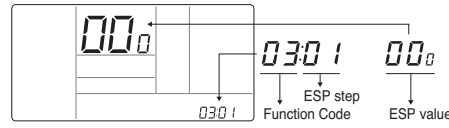

**3** Select ESP fan step by pressing button. (01: very low, 02: low, 03: medium, 04: high, 05: very high)

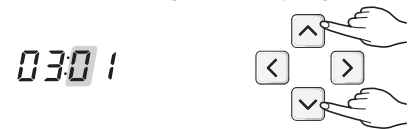

**4** Move to ESP value setting by pressing button.  
(It is 000 when delivering from the warehouse.)



**5** Press button to setup ESP value.  
(It is possible to setup ESP value from 1 to 255, and 1 is the smallest and 255 is the biggest.)

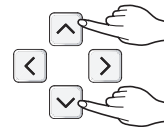

Function code,  
ESP code  
ESP value

- When setting ESP value on the product without very weak wind or power wind function, it may not work.

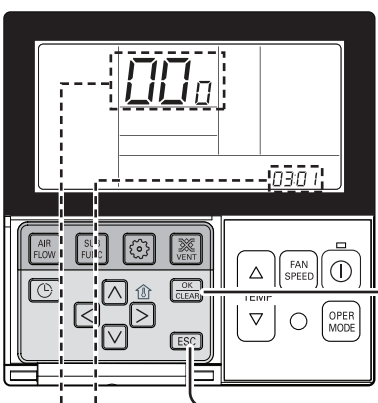

**6** Select ESP fan step again by using button and setup ESP value, as No. 4 and 5, that corresponds each wind flow

**7** Press button to save.

**8** Press button to exit.  
\* After setup, it automatically gets out of setup mode if there is no button input for 25 seconds.  
\* When exiting without pressing set button, the manipulated value is not reflected.

Function code, ESP code  
ESP value

- Please be careful not to change the ESP value for each fan step.
- It does not work to setup ESP value for very low/power step for some products.
- ESP value is available for specific range belongs to the product.

E.S.P. setting value (reference)

Table 1

ABNH18GHLA2

(Unit: CMM)

Setting Value	Static Pressure[mmAq(Pa)]				
	2.5(25)	4(39)	6(59)	8(78)	10(98)
100	12.8	-	-	-	-
105	13.9	-	-	-	-
110	15.2	12.7	-	-	-
115	16.5	14.0	-	-	-
120	17.8	15.3	12.7	-	-
125	-	16.5	14.0	-	-
130	-	17.8	15.3	12.6	-
135	-	-	16.5	13.5	-
140	-	-	17.5	14.5	12.3
145	-	-	-	16.5	13.5

ABNH24GHLA2

(Unit: CMM)

Setting Value	Static Pressure[mmAq(Pa)]				
	2.5(25)	4(39)	6(59)	8(78)	10(98)
105	13.9	-	-	-	-
110	15.2	12.7	-	-	-
115	16.5	14.0	-	-	-
120	17.8	15.3	12.7	-	-
125	-	16.5	14.0	-	-
130	-	17.8	15.3	12.6	-
135	-	-	16.5	13.5	-
140	-	-	17.6	14.5	12.3
145	-	-	-	16.5	13.5
150	-	-	-	18.0	15.2

ABNH30GGLA2

(Unit: CMM)

Setting Value	Static Pressure[mmAq(Pa)]				
	4(49)	6(59)	8(78)	10(98)	12(118)
100	20.8	-	-	-	-
105	23.2	19.5	-	-	-
110	26.0	21.5	-	-	-
115	-	23.5	19.1	-	-
120	-	26.3	21.6	-	-
125	-	-	24.0	19.9	-
130	-	-	27.0	22.7	-
135	-	-	-	25.9	21.3
140	-	-	-	-	24.5

[ Notes ]

1. To get the desired Airflow & E.S.P. combination from the table set the matching value from the table. Value other than that in table will not give the combinations of airflow & E.S.P. which are mentioned in the table.
2. Table data is based at 230V. According to the fluctuation of voltage, air flow rate varies.

**ABNH36GGLA2**

(Unit: CMM)

Setting Value	Static Pressure[mmAq(Pa)]				
	4(49)	6(59)	8(78)	10(98)	12(118)
115	25.9	-	-	-	-
120	27.9	-	-	-	-
125	29.9	26.4	-	-	-
130	32.0	28.5	25.0	-	-
135	-	30.7	27.5	-	-
140	-	32.9	29.9	26.0	-
145	-	-	32.3	28.5	24.7
150	-	-	-	31.0	27.3
155	-	-	-	-	29.9

**ABNH42GRLA2**

(Unit: CMM)

Setting Value	Static Pressure[mmAq(Pa)]				
	6(59)	8(78)	10(98)	12(118)	14(137)
85	31.5	-	-	-	-
90	36.3	29.8	-	-	-
95	41.3	34.5	28.4	-	-
100	45.4	39.7	33.5	27.3	-
105	-	44.1	38.6	33.1	27.6
110	-	-	44.2	38.9	33.6
115	-	-	-	44.7	39.6

**ABNH48GRLA2**

(Unit: CMM)

Setting Value	Static Pressure[mmAq(Pa)]				
	6(59)	8(78)	10(98)	12(118)	14(137)
85	31.5	-	-	-	-
90	36.3	29.8	-	-	-
95	41.3	34.5	28.4	-	-
100	45.4	39.7	33.5	27.3	-
105	-	44.1	38.6	33.1	27.6
110	-	-	44.2	38.9	33.6
115	-	-	-	44.7	39.6

**ABNH60GRLA2**

(Unit: CMM)

Setting Value	Static Pressure[mmAq(Pa)]				
	6(59)	8(78)	10(98)	12(118)	14(137)
95	41.3	-	-	-	-
100	45.4	39.7	-	-	-
105	49.5	44.1	38.6	-	-
110	-	48.5	44.2	38.9	-
115	-	-	49.8	44.7	42.2
120	-	-	-	50.5	48.1

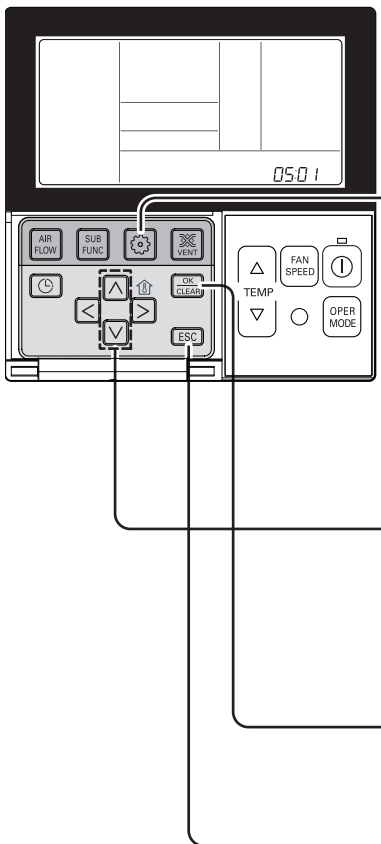



**Table 2**



Model	Mode		Set value	Standard ESP(mmAq(Pa))	CMM	Lower Limit of External Static Pressure (mmAq(Pa))	Upper Limit of External Static Pressure (mmAq(Pa))
ABNH18GHLA2	High (factory set)	HI	145	8(78)	16.5	2.5(25)	10(98)
		Mid	140		14.5		
		Low	134		13.0		
ABNH24GHLA2	High (factory set)	HI	150	8(78)	18.0	2.5(25)	10(98)
		Mid	145		16.5		
		Low	136		14.0		
ABNH30GGLA2	High (factory set)	HI	137	10(98)	26.5	2.5(25)	10(98)
		Mid	131		23.0		
		Low	126		20.0		
ABNH36GGLA2	High (factory set)	HI	152	10(98)	32.0	4(39)	10 (98)
		Mid	146		29.0		
		Low	141		26.5		
ABNH42GRLA2	High (factory set)	HI	106	10(98)	36.0	5(49)	12(118)
		Mid	102		32.0		
		Low	99		28.0		
ABNH48GRLA2	High (factory set)	HI	110	10(98)	40.0	5(49)	12(118)
		Mid	106		35.0		
		Low	103		30.0		
ABNH60GRLA2	High (factory set)	HI	123	10(98)	49.0	6(59)	14(137)
		Mid	120		45.0		
		Low	115		40.0		



## 4.2 High Ceiling operation

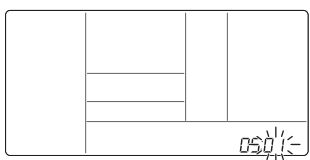

This function is to adjust FAN Airflow rate according to ceiling height (For ceiling type product)

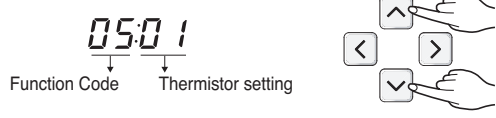

- 1** If pressing  button long for 3 seconds, it enters into remote controller setter setup mode.  
- If pressing once shortly, it enters into user setup mode.  
Please press more than 3 seconds for sure.
- 2** If moving to ceiling height selection menu by pressing  button, it indicates as picture below.

- 3** Select ceiling height value by pressing   button. (01:Low, 02:Medium, 03:High, 04:Very high)

- 4** Press  button to save.

- 5** Pressing  button will exit settings mode.  
\* After setup, it automatically gets out of setup mode if there is no button input for 25 seconds.  
\* When exiting without pressing set button, the manipulated value is not reflected.

### <Ceiling Height Selection Table>

Ceiling Height Level		Description
01	Low	Decrease the indoor airflow rate 1 step from standard level
02	Medium	Set the indoor airflow rate as standard level
03	High	Increase indoor airflow rate 1 step from standard level
04	Very high	Increase indoor airflow rate 2 steps from standard level

- Ceiling height setting is available only for some products.
- Ceiling height of 'Very high' function may not exist depending on the indoor unit.
- Refer to the product manual for more details.

## 5. Reliability

### 5.1 Hot start

- When heating is started, the indoor fan is stopped or very slow to prevent the cold air carry out
- When the temp. of heat exchanger reach 30°C(model by model), indoor fan is started.

### 5.2 Self-diagnosis Function

- The air conditioner installed can self-diagnosed its error status and then transmits the result to the central control. Therefore, a rapid countermeasure against failure of the air conditioner allows easy management and increases the usage life of air conditioner.
- Refer to trouble shooting guide.

### 5.3 Soft dry operation

- When the dehumidification operation input by the remote control is received, the intake air temperature is detected and the setting temp is automatically set according to the intake air temperature.

Intake air Temp.	Setting Temp.
26°C ≤ intake air temp.	25°C
24°C ≤ intake air temp. < 26°C	intake air temp. -1°C
22°C ≤ intake air temp. < 24°C	intake air temp. -0.5°C
18°C ≤ intake air temp. < 22°C	intake air temp.
intake air temp. < 18°C	18°C

- While compressor off, the indoor fan repeats low airflow speed and stop.
- While the intake air temp is between compressor on temp. and compressor off temp., 10-min dehumidification operation and 4-min compressor off repeat.

Compressor ON Temp. → Setting Temp+0.5°C  
 Compressor OFF Temp. → Setting Temp-0.5°C

- In 10-min dehumidification operation, the indoor fan operates with the low airflow speed.

## 6. Convenience Functions & Controls

### 6.1 Cooling & heating Operations

#### 6.1.1 Cooling Mode

- Operating frequency of compressor depends on the load condition, like the difference between the room temp. and the set temp., frequency restrictions.
- If the compressor operates at some frequency, the operating frequency of compressor cannot be changed within 30 seconds. ( not emergency conditions)
- Compressor turned off when
  - intake air temperature is in between  $\pm 0.5^{\circ}\text{C}$  of the setting temp. limit for three minutes continuously.
  - intake air temperature reaches below  $1.0^{\circ}\text{C}$  of the temperature of setting temp..
- Compressors three minutes time delay.
  - After compressor off, the compressor can restart minimum 3 minutes later.

#### 6.1.2 Heating Mode

- Operating frequency of compressor depend on the load condition, The difference between the room temp. and set temp., frequency restrictions.
- If compressor operates at some frequency, the operating frequency of compressor cannot be changed within 30 seconds.
- Condition of compressor turned off
  - When intake air temperature reaches  $+4^{\circ}\text{C}$  above the setting temperature.
- Condition of compressor turned on
  - When intake air temperature reaches  $+2^{\circ}\text{C}$  above the setting temperature.
- \* Condition of indoor fan turned off
  - While in compressor on : indoor pipe temp.  $< 20^{\circ}\text{C}$
  - While in compressor off : indoor pipe temp.  $< 30^{\circ}\text{C}$
- While in defrost control, between the indoor and outdoor fans are turned off.
- Compressor 2minutes delay
  - After compressor off, the compressor can restart minimum 2 minutes later.

**NOTE:** Some Models are different by temperature of thermo ON/OFF.

CST/Duct/CVT type indoor unit matched with Universal Outdoor unit	CST/ Duct/CVT type indoor unit matched with Single Outdoor unit/Multi Outdoor unit/Multi V Outdoor unit
Thermo ON : $+2^{\circ}\text{C}$ above setting temp. Thermo OFF : $+4^{\circ}\text{C}$ above setting temp.	Thermo ON : Setting temp. Thermo OFF : $+3^{\circ}\text{C}$ above setting temp.

## 6.2 Auto cleaning operation

- Function used to perform Self Cleaning to prevent the Unit from Fungus and bad odor.
- Used after the Cooling Operation before turning the unit off, clean the Evaporator and keep it dry for the next operation.
- The function is easy to operate as it is accessed through the Remote controller.

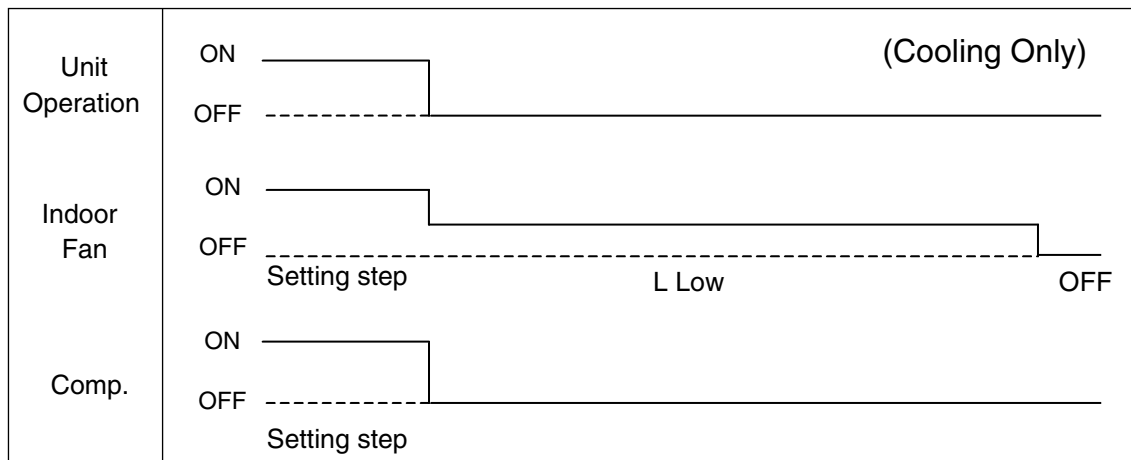

## 6.3 Auto changeover operation

- The air conditioner changes the operation mode automatically to keep indoor temperature.
- When room temperature vary over  $\pm 2^{\circ}\text{C}$  with respect to setting temperature, air conditioner keeps the room temperature in  $\pm 2^{\circ}\text{C}$  with respect to setting temperature by auto change mode.

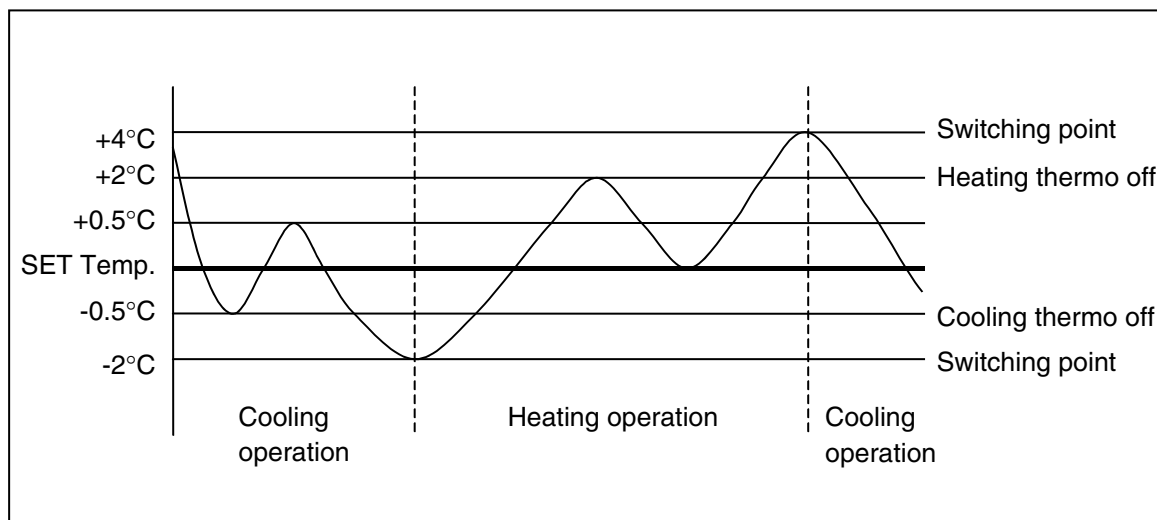

## 6.4 Auto restart Operation







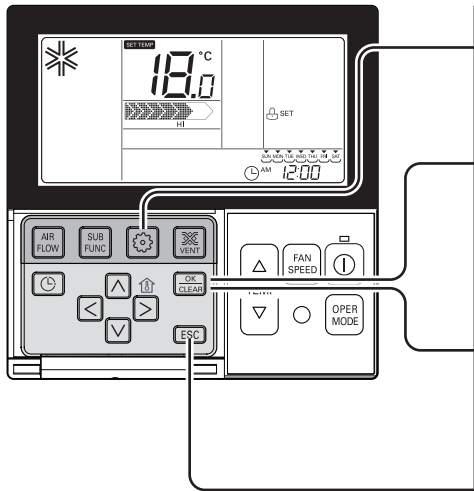



- Whenever there is electricity failure to the unit, and after resumption of the power, unit will start in the same mode prior to the power failure. Memorized condition are on / off condition, operating mode (cooling/ heating), set temperature and fan speed. The unit will memorize the above conditions and start with same memorized condition.

## 6.5 Child Lock Function

It is the function to use preventing children or others from careless using.



The diagram shows the control panel of an air conditioner. Callouts 1, 2, and 3 point to the 'SUB FUNC' button (gear icon), the left and right arrow buttons, and the 'OK CLEAR' button respectively. Callout 4 points to the 'ESC' button.

- 1** Press  button repeatedly until the  is flashing. 
- 2** If moving to 'setup' icon area by using   button, 'setup' icon blinks, and child lock function is setup if pressing  button at that time. 
- 3** When cancelling lock function, if moving to 'cancel' icon by pressing   button and then, pressing  button, child lock function is cancelled.
- 4** Press  button to exit.  
 \* After setup, it automatically gets out of setup mode if there is no button input for 25 seconds.  
 \* When exiting without pressing set button, the manipulated value is not reflected.

## 6.6 Forced operation

- To operate the appliance by force in case when the remote control is lost, the forced operation selection switch is on the main unit of the appliance, and operate the appliance in the standard conditions.
- The operating condition is set according to the outdoor temp. and intake air temperature as follows.

Indoor temp.	Operating Mode	Setting temp.	Setting speed of indoor fan
over 24°C	Cooling	22°C	High speed
21~24°C	Healthy Dehumidification	23°C	
below 21°C	Heating	24°C	

- The unit select the last operation mode in 3 hours.
- Operating procedures when the remote control can't be used is as follows :
  - The operation will be started if the ON/OFF button is pressed.
  - If you want to stop operation, re-press the button.

## 6.7 Group Control

### 1. When installing more than 2 units of air conditioner to one wired remote controller, please connect as the right figure.

- If it is not event communication indoor unit, set the unit as slave.
- Check for event communication through the product manual.

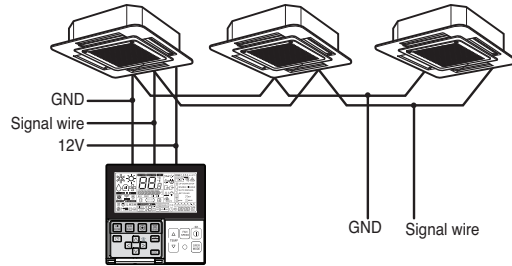

When controlling multiple indoor units with event communication function with one remote controller, you must change the master/slave setting from the indoor unit.

- Indoor units, the master/slave configuration of the product after completion of indoor unit power 'OFF' and then 'ON' the power after 1 minutes elapsed sign up.
- For ceiling type cassette and duct product group, change the switch setting of the indoor PCB.

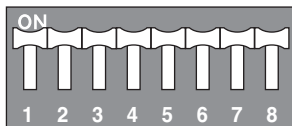

#3 switch OFF: Master  
(Factory default setting)

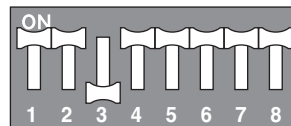

#3 switch ON: Slave

- For wall-mount type and stand type product, change the master/slave setting with the wireless remote controller. (Refer to wireless remote controller manual for detail)
- ※ When installing 2 remote controllers to one indoor unit with event communication function, set the master/slave of the remote controller. (Refer to remote controller master/slave selection)  
When controlling the group, some functions excluding basic operation setting, fan level Min/Mid/Max, remote controller lock setting and time setting may be limited.

### 2. When installing more than 2 wired remote controllers to one air conditioner, please connect as the right picture.

- When installing more than 2 units of wired remote controller to one air conditioner, set one wired remote controller as master and the others all as slaves, as shown in the right picture.
- You cannot control the group as shown in the right for some products.
- Refer to the product manual for more detail.

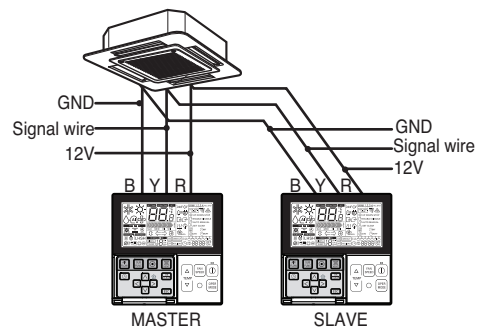

<When simultaneously connecting 2 sets of wired remote controller>

- When controlling in groups, set the master/slaver of the remote controller. Refer to Installer setting section on how to set master/slave for more detail.

## 6.8 Sleep Timer Operation

- When the sleep time is reached after <1,2,3,4,5,6,7,0(cancel) hr> is input by the remote control while in appliance operation, the operation of the appliance stops.
- While the appliance is on pause, the sleep timer mode cannot be input.
- While in cooling mode operation, 30 min later since the start of the sleep timer, the setting temperature increases by 1°C. After another 30 min elapse, it increases by 1°C again.
- When the sleep timer mode is input while in cooling cycle mode, the airflow speed of the indoor fan is set to the low.
- When the sleep timer mode is input while in heating cycle mode, the airflow speed of the indoor fan is set to the medium.

## 6.9 Timer(On/Off)

### 6.9.1 On-Timer Operation

- When the set time is reached after the time is input by the remote control, the appliance starts to operate.
- The timer LED is on when the on-timer is input. It is off when the time set by the timer is reached.
- If the appliance is operating at the time set by the timer, the operation continues.  
While in Fuzzy operation, the airflow speed of the indoor fan is automatically selected according to the temperature.

### 6.9.2 Off-Timer Operation

- When the set time is reached after the time is input by the remote control, the appliance stops operating.
- The timer LED is on when the off-timer is input. It is off when the time set by the timer is reached.
- If the appliance is on pause at the time set by the timer, the pause continues.



## 6.10 Weekly Program

You can set the daily reservation in weekly unit.

Weekly reservation keeps operating until before you cancel it once you setup

<p><b>1</b> Please move to reservation setup mode by pressing reservation button. * You can setup two weekly reservations for one day, and up to fourteen reservations for a week. For example, to setup (Tuesday morning 11:30 turned on ~ afternoon 12:30 turned off), you setup in order below.</p>	
<p><b>2</b> Please move to 'weekly' by repeatedly pressing reservation button. 'Weekly' blinks at this time.</p>	
<p><b>3</b> Please select weekly reservation or weekly reservation i by using   button. * You can setup two reservations, weekly reservation 1 and weekly reservation 2, for a day.</p>	
<p><b>4</b> Please move to 'date' setup part by using   button. If 'date' indication blinks, please setup date. You can setup date from Monday to Sunday.</p>	
<p><b>5</b> Please move to 'AM/PM' setup part of turning on by using   button.</p>	
<p><b>6</b> Please move to 'hour' setup part of turning on by using   button. - It is the part to setup the time at which air-conditioner is turned on.</p>	
<p><b>7</b> Please change time by using   button. - You can setup hour 0~12.</p>	
<p><b>8</b> Please move to 'minute' setup part of turning on by using  button.</p>	
<p><b>9</b> If 'minute' indication blinks, please setup 'minute' by using   button</p>	

**10** Please move to 'AM/PM' setup part of turning off by using  button.  
 - AM/PM setup is identical with turning on time setup.

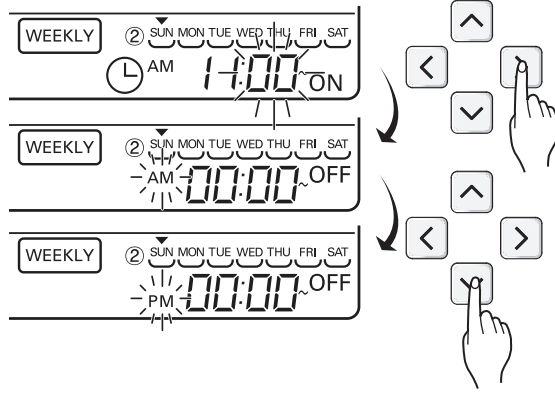

**11** Please move to 'hour' setup part of turning off by using Right button.  
 - It is the part to reserve the time at which air-conditioner is turned off.  
 - If 'hour' indication blinks, please setup 'hour'.

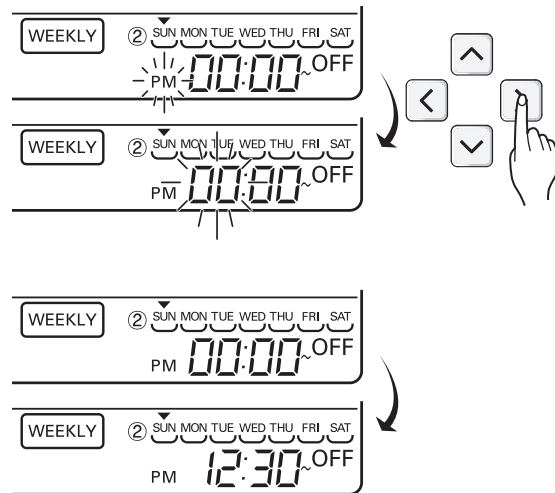

\* Please setup 'hour' and 'minute' identically with the method to setup turning on time.

**12** If finishing weekly reservation setup, please press setup/cancellation button. Weekly reservation setup for the day that you set is finished.

**13** If you setup with the method identical with above by selecting the day that you'd like to setup, it operates weekly reservation.  
 If you setup both turning on reservation time and turning off reservation time identically, it doesn't operate reservation drive.

**Weekly reservation explanation**

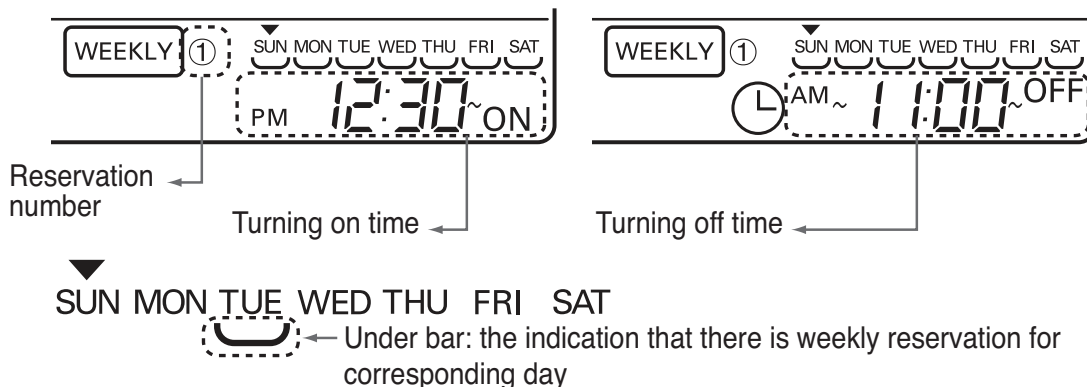

\* Indoor unit is turned on to desired temperature if it is configured using up/down button during preset of weekly operation time.  
 (Temperature selection range : 18°C~30°C)  
 - When desired temperature is not set, it is turned on automatically with desired temperature of previous operation.

## 6.11 Two Thermistor Control

This is the function to select the temperature sensor to judge the room temperature.

- If pressing button long for 3 seconds, it enters into remote controller setter setup mode.  
- If pressing once shortly, it enters into user setup mode.  
Please press more than 3 seconds for sure.
- If moving to room temperature perception sensor selection menu by pressing button, it indicates as picture below.
- Set Thermistor value by pressing button. (01: Remote Controller, 02: Indoor, 03: 2TH)

Function Code      Thermistor setting
- Press button to save.
- Pressing button will exit settings mode.  
 \* After setup, it automatically gets out of setup mode if there is no button input for 25 seconds.  
 \* When exiting without pressing set button, the manipulated value is not reflected.

### <Thermistor Table>

Temperature sensor selection		Function
01	Remote controller	Operation in remote controller temperature sensor
02	Indoor unit	Operation in indoor unit temperature sensor
03	2TH	Cooling Operation of higher temperature by comparing indoor unit's and wired remote controller's temperature. (There are products that operate at a lower temperature.)
		Heating Operation of lower temperature by comparing indoor unit's and wired remote controller's temperature.

\* The function of 2TH has different operation characteristics according to the product.

## 7. Special Function & KIT

### 7.1 Low Ambient control

- This Function is for cooling operating in outdoor low temperature .
- If outdoor temperature drops below certain temperature, liquid back is prevented by reducing outdoor fan speed.
- It can prevent frosting of evaporator and keep cooling operation

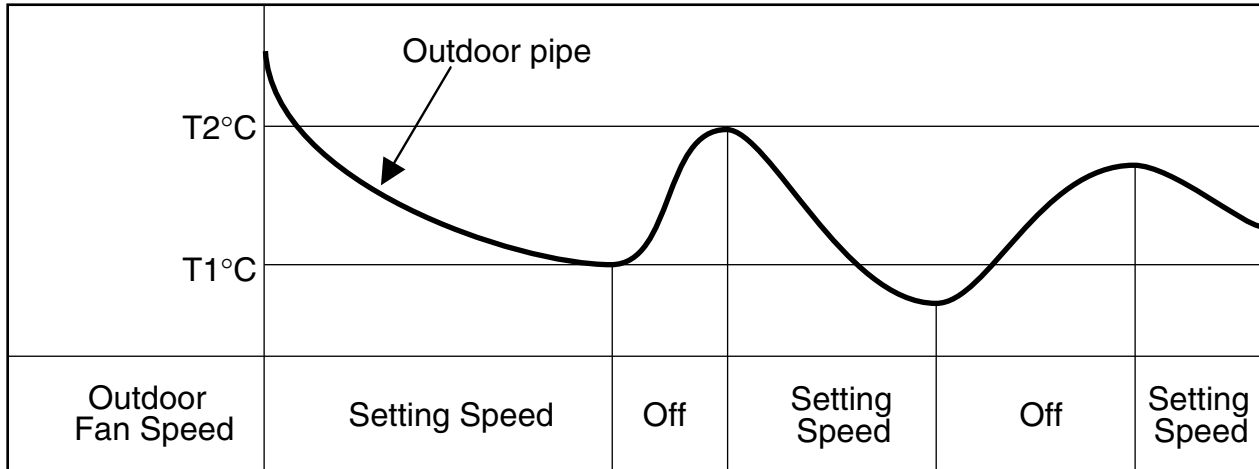

### 7.2 Space control

Vanes angle can be controlled by pair, considering its installation environment.

- For example direct drafts can be annoying, leading to discomfort and reduced productivity vane control helps to eliminate this problem.
- Easily controlled by wired remote control.
- Air Flow can be controlled easily regarding any space environment.

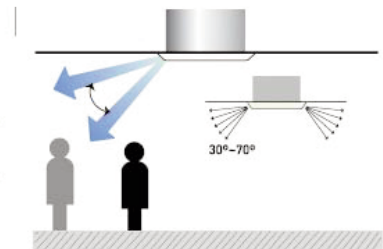

### 7.3 Auto Elevation Grille

- Auto Elevation Grille is automatically down to height of max. 3.1 m. So it enables to install the Indoor unit at high ceiling space. And Auto Elevation Grille makes you cleaning the filter easily.

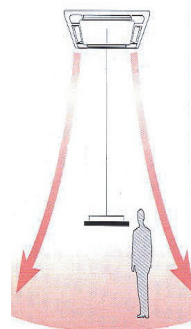

## ■ ELEVATION GRILL (REMOTE CONTROLLER\_Accessory)

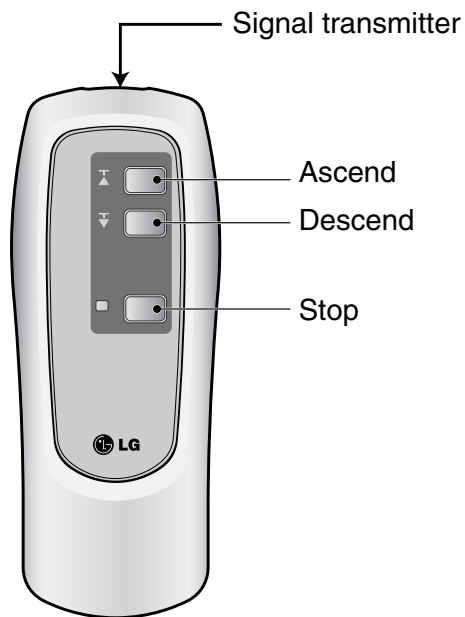

### • Main Components of Lift Grill

- ① Lift grill front panel assembly
- ② Bolts for installation (4 EA, P/No. 3A00255K)
- ③ Instruction manual
- ④ Remote Controller for lift grill

### • How to Use Remote Controller

As for operation of Remote Controller, use it by directing the transmitter part of Remote Controller to the receiver part of front panel directly under front panel.

- Do not drop it down or into water. Or else there is worry about trouble failure.
- Do not press hard the Remote Controller button with nail (ball-point pen or other sharp substance). Or else there is worry about trouble failure.
- In case when obstacle such as curtain hides the signal reception part of receiver in between the space interval, Remote Controller operation is infeasible.

• How to Operate the Lift Grill

**⚠ CAUTION**

- Always stop the air conditioner operation for safety before operating lift grill.
- Take heed \_ there is worry about dust fall etc. when suction grill descends.
- In case when the set automatic stop distance goes wrong, check the set value of operation panel and confirm if there is neither obstacle nor mankind.
- When you are not to remove obstacle, stop the operation before touching the obstacle.

1. Stop the Air Conditioner Operation

Automatic Stop Distance of Grill

2. Descend the Suction Grill

- Depress the down button(▼).  
Then suction grill descends and stops automatically at a certain distance.
- You may stop it at wanted distance point by depressing the stop button (■) when descending.

3. Raise the Suction Grill

- Depress the up button(▲).  
Then suction grill goes up and enters into the front panel.

4. Stop the Suction Grill during Rising

- Depress the stop button(■).  
Make use of this when you want to stop it at your wished position.

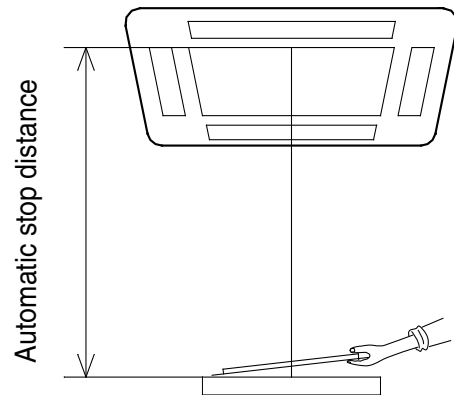

Ceiling height	Low	Medium (Height: 3~4 m)	High
Automatic stop distance	1.5±0.5 m	2.5±0.5 m	3.5±0.5 m

\* If you want to change automatic distance setting, consult with your sale agency.

## 3. Basic Control

1. Normal operation.....	40
2 Compressor control .....	40
3. EEV( Electronic Expansion Valve) control .....	40

## 1. Normal operation

Basic principle is to control the rpm of the motor by changing the working frequency of the compressor. Three phase voltage is supplied to the motor and the time for which the voltage will supplied is controlled by IPM (intelligent power module). Switching speed of IPM defines the variable frequency input to the motor.

Actuator	Cooling operation	Heating operation	Stop state
Compressor	Fuzzy control	Fuzzy control	Stop
Fan	Fuzzy control	Fuzzy control	Stop
EEV	Super heating fuzzy control	Discharge Temp. Control	Min. Pulse

## 2. Compressor control

Fuzzy control : Maintain evaporating temperature (Te) to be constant on cooling mode and constant condensing temperature (Tc) on heating mode by fuzzy control to ensure the stable system performance.

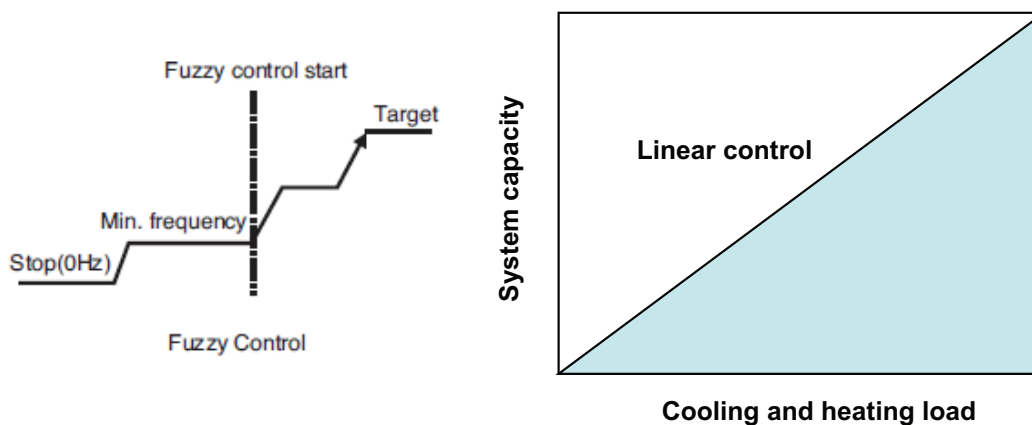

Inverter linear control as cooling and heating load increasing

## 3. EEV( Electronic Expansion Valve) control

EEV operates with fuzzy control rules to keep The degree of superheat (2~3°C) or the target temperature of discharge pipe.

\* Cooling mode  
 The degree of superheat =  $T_{suction} - T_{evaporator}$   
 $T_{suction}$  : temperature at suction pipe sensor(°C)  
 $T_{evaporator}$  : evaporation temperature (°C)

\* Heating mode  
 the target temperature of discharge pipe =  $T_{condenser} + \alpha$   
 $T_{condenser}$  : condenser temperature (°C)



## 4. Trouble Shooting

<b>1. Self-diagnosis Function</b> .....	<b>42</b>
1.1 Error Indicator (Indoor).....	42
1.2 Error Indicator (Outdoor).....	43
<b>2. Pump Down</b> .....	<b>44</b>
<b>3. Evacuation</b> .....	<b>45</b>
<b>4. Gas Charging</b> .....	<b>46</b>
<b>5. Cycle Part</b> .....	<b>47</b>
<b>6. Electronic Parts</b> .....	<b>48</b>
6.1 The Product doesn t operate at all.....	48
6.2 The Product doesn't operate with the remote controller .....	49
6.3 The Compressor/Outdoor Fan are don't operate .....	50
6.4 When indoor Fan does not operate.....	51
6.5 When the louver does not operate.....	52
6.6 Troubleshooting Indoor Error .....	53
6.7 Troubleshooting Outdoor Error .....	59

## 1. Self-diagnosis Function

### 1.1 Error Indicator (Indoor)

#### Ceiling Cassette Type Display

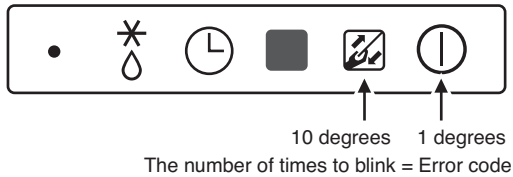

#### Standard Libero Type Display

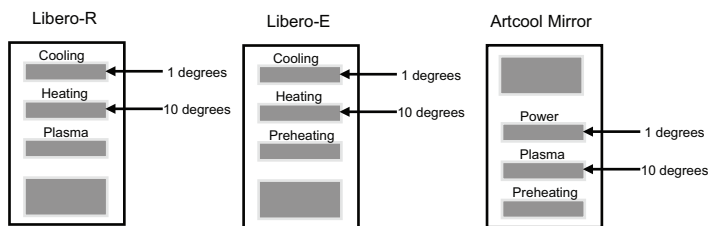

#### Error Indicator

- The function is to self-diagnosis airconditioner and express the troubles identifiably if there is any trouble.
- Error mark is ON/OFF for the operation LED of evaporator body in the same manner as the following table.
- If more than two troubles occur simultaneously, primarily the highest trouble fo error code is expressed.
- After error occurrence, if error is released, error LED is also released simultaneously.
- To operate again on the occurrence of error code, be sure to turn off the power and then turn on.
- Having or not of error code is different from Model.

#### Indoor Error

Error code	Description	Indoor Status
00	No Error	ON
01	Indoor Room themistor error	OFF
02	Indoor in-piping sensor error	OFF
03	Remote controller error	OFF
04	Drain Pump error	OFF
05	Communcation error between in and out	OFF
06	Indoor Out-Piping sensor error	OFF
07	Differnt mode operation	OFF
09	EEPROM Check Sum Error	OFF
10	Indoor BLDC Fan Lock	OFF

## 1.2 Error Indicator (Outdoor)

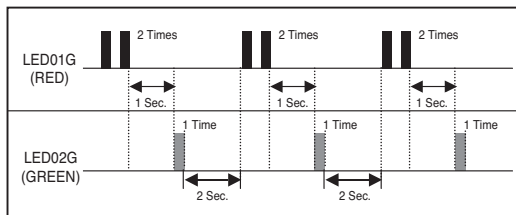

Outdoor Error  
Ex) Error 21 (DC Peak)

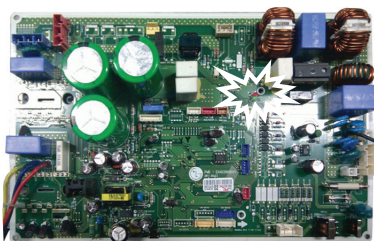

UU18W/24W/30W

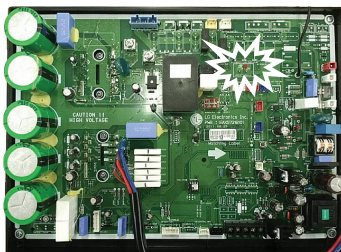

UU36W/42W/48W/60W

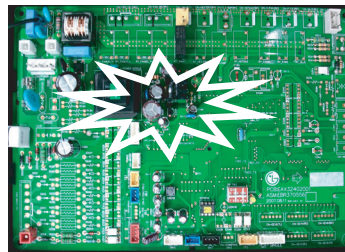

UU37W/43W/49W/61W

Error Code	Description	LED 1 (Red)	LED 2 (Green)	Indoor status
21	DC Peak(IPM Fault)	2times ●	1time ●	OFF
22	Max. CT(CT2)	2times ●	2times ●	OFF
23	DC Link Low Volt.	2times ●	3times ●	OFF
24	Pressure switch/Heater Sink.	2times ●	4times ●	OFF
26	DC Comp Position Error	2times ●	6times ●	OFF
27	PFC Fault Error	2times ●	7times ●	OFF
29	Comp Over Current	2times ●	9times ●	OFF
32	D-Pipe High(Inv.)	3times ●	2times ●	OFF
40	CT Sensor(Open/Short)	4times ●	0	OFF
41	Inv. D-Pipe Th Error(Open/Short)	4times ●	1time ●	OFF
43	High Pressure Sensor(Open/Short)	4times ●	3times ●	OFF
44	Outdoor air Th Error(Open/Short)	4times ●	4times ●	OFF
45	Cond. Middle Pipe Th Error(Open/Short)	4times ●	5times ●	OFF
46	Suction Pipe Th Error(Open/Short)	4times ●	6times ●	OFF
48	Cond. Out-Pipe Th Error(Open/Short)	4times ●	8time ●	OFF
51	Capacity over	5times ●	1times ●	OFF
53	Communication Error(Indoor ↔ Outdoor)	5times ●	3times ●	OFF
60	EEPROM Error(Outdoor)	6times ●	0	OFF
61	Cond. Middle Pipe High	6times ●	1times ●	OFF
62	Heatsink Error(High)	6times ●	2times ●	OFF
65	Heatsink Th Error(Open/Short)	6times ●	5times ●	OFF
67	BLDC motor fan lock(Outdoor)	6times ●	7times ●	OFF

If abnormal voltage is supplied, the protection circuits will turn off the product in order to prevent the component damage. The product will automatically restart after 3 minutes.

● : A light on the display panel is blink.

## 2. Pump Down

### Setting Procedure

1) Set the Dip Switch as follow after shutting the power source down.

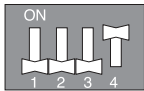

UU18W  
UU24W  
UU30W

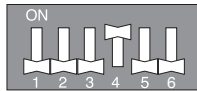

UU36W  
UU42W  
UU48W  
UU60W

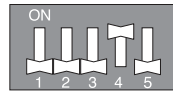

UU37W  
UU43W  
UU49W  
UU61W

- 2) Reset the power.
- 3) Red LED and Green LED of PCB lights during work.  
(The indoor unit is operated by force.)
- 4) If operation is done, Red LED will be turned off.  
If operation is not done normally, Red LED will blink.
- 5) Close the Liquid valve only after green LED turned off (7 minutes from the start of the machine).  
Then close the gas valve after Green LED on.



#### WARNING:

- When the green LED of PCB is on, compressor is going to be off because of low pressure.
- You should return the Dip Switch to operate normally after finishing the operation.
- Improper Pump down will lead to product turn off along with LED (green & red) off with in 20 minutes from the initial start.

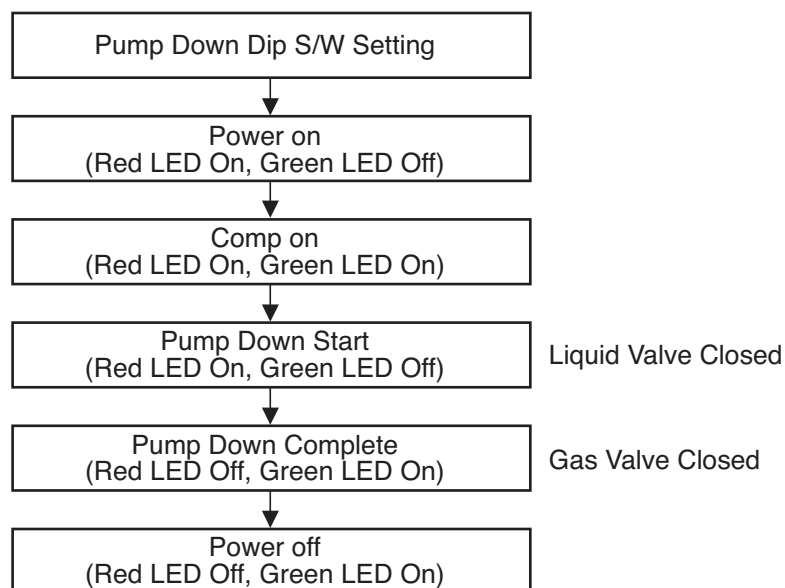

### 3. Evacuation (All amount of refrigerant leaked)

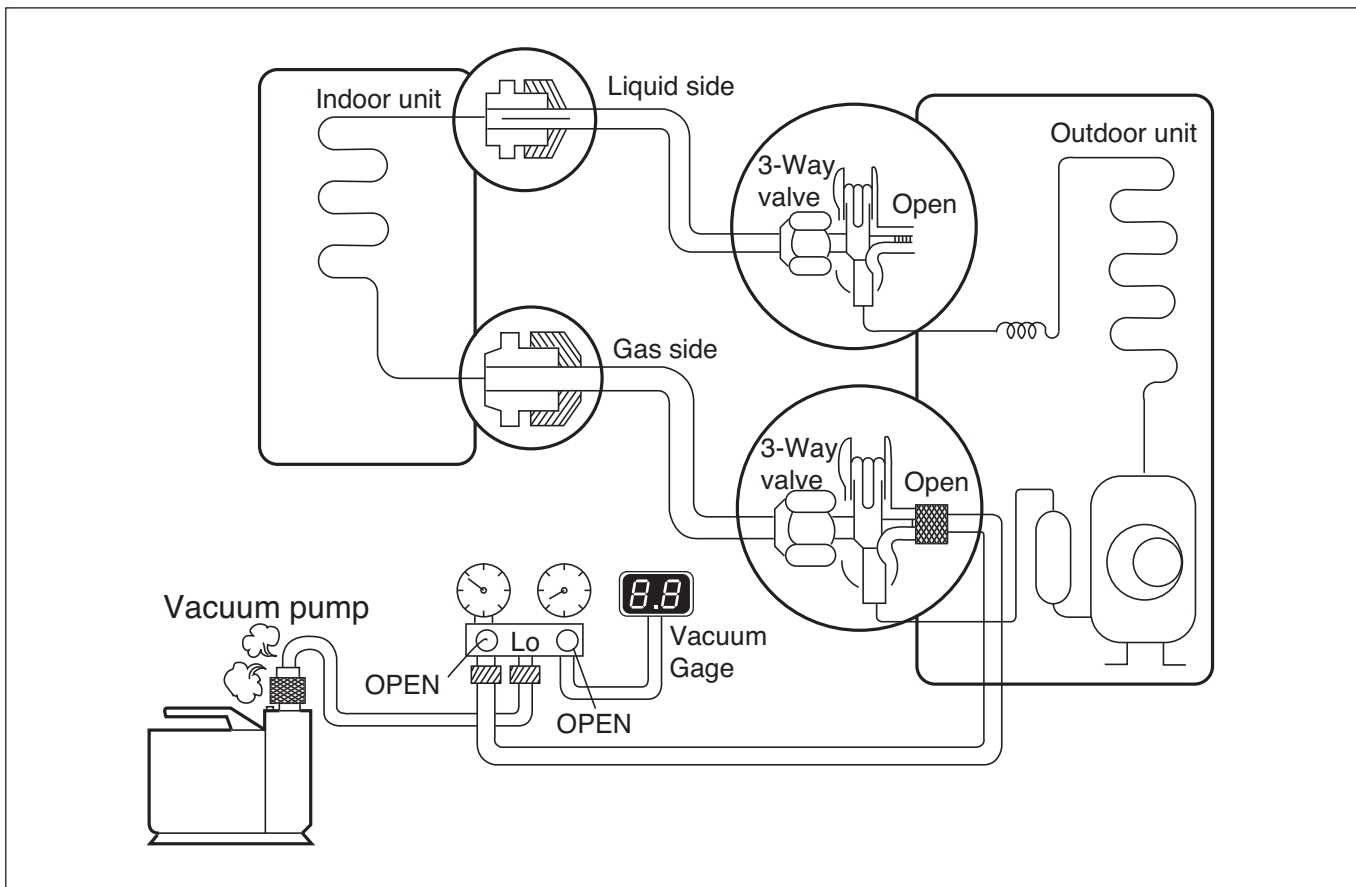

#### • Procedure

- (1) Connect the vacuum pump to the center hose of charge set center hose
- (2) Evacuation for approximately one hour.
  - Confirm that the gauge needle has moved toward 0.8Torr.
- (3) Close the valve (Lo side) on the charge set, turn off the vacuum pump, and confirm that the gauge needle does not move (approximately 5 minutes after turning off the vacuum pump).

- (4) Disconnect the charge hose from the vacuum pump.
  - Vacuum pump oil.
  - If the vacuum pump oil becomes dirty or depleted, replenish as needed.

#### **! WARNING**

Use a vacuum pump or Inert (nitrogen) gas when doing leakage test or air purge. Do not compress air or Oxygen and do not use Flammable gases. Otherwise, it may cause fire or explosion.

- Otherwise, it may cause personal injury.

## 4. Gas Charging (After Evacuation)

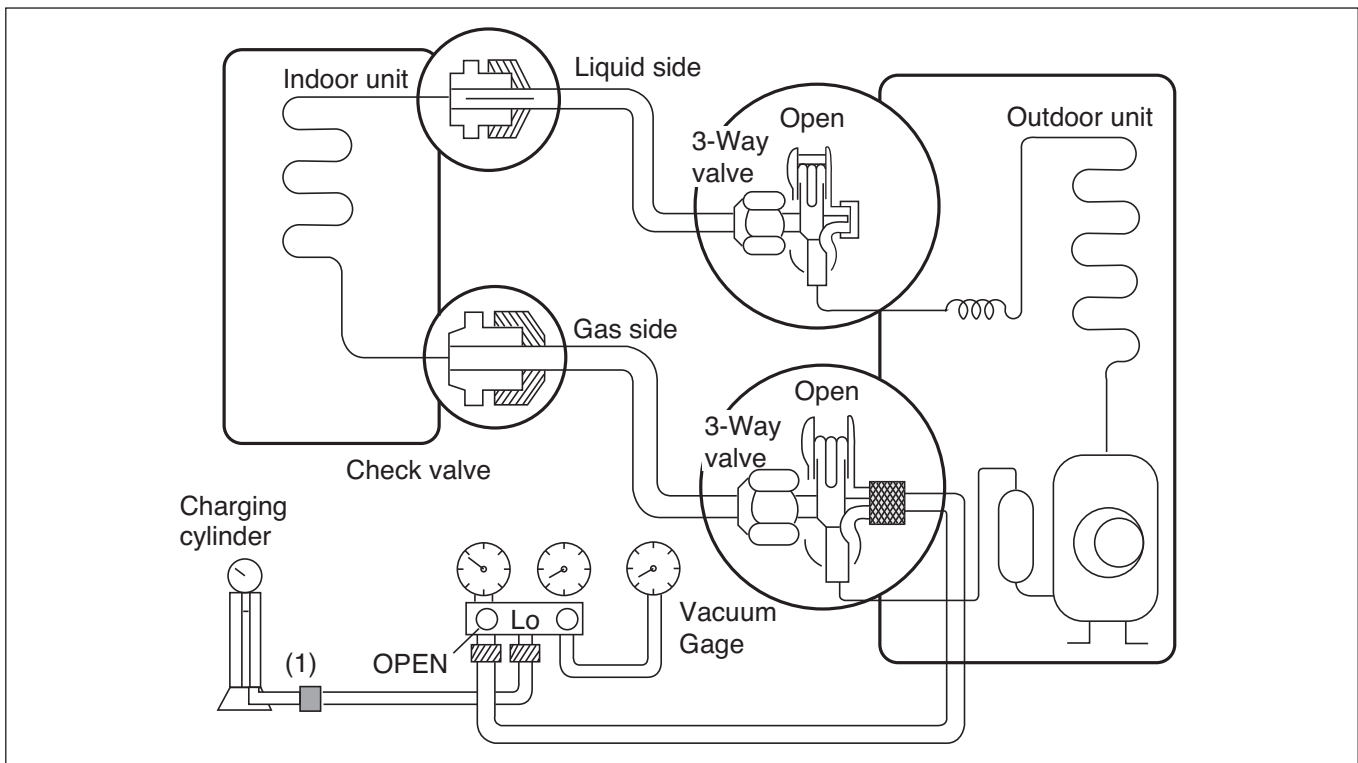

### • Procedure

#### (1) Connect the charge hose to the charging cylinder.

- Connect the charge hose which you disconnected from the vacuum pump to the valve at the bottom of the cylinder.
- If you are using a gas cylinder, also use a scale and reverse the cylinder so that the system can be charged with liquid.

#### (2) Purge the air from the charge hose.

- Open the valve at the bottom of the cylinder and press the check valve on the charge set to purge the air. (Be careful of the liquid refrigerant). The procedure is the same if using a gas cylinder.

#### (3) Open the valve (Lo side on the charge set and charge the system with liquid refrigerant.

- If the system can not be charged with the specified amount of refrigerant, it can be charged with a little at a time (approximately 150g each time) while operating the air conditioner in the cooling cycle; however, one time is not sufficient, wait approximately 1 minute and then repeat the procedure (pumping down-pin).

This is different from previous procedures.

Because you are charging with liquid refrigerant from the gas side, absolutely do not attempt to charge with larger amounts of liquid refrigerant while operating the air conditioner.

#### (4) Immediately disconnect the charge hose from the 3-way valve's service port.

- Stopping partway will allow the gas to be discharged.
- If the system has been charged with liquid refrigerant while operating the air conditioner turn off the air conditioner before disconnecting the hose.

#### (5) Mount the valve stem nuts and the service port nut.

- Use torque wrench to tighten the service port nut to a torque of 1.8 kg.m.
- Be sure to check for gas leakage.

### **!** WARNING

When installing or relocation the unit, make sure that no substance other than the specified refrigerant(R410A) enter the refrigerant circuit.

- Any presence of foreign substance such as air can cause an abnormal pressure rise and may result in explosion or injury.

## 5. Cycle Part

### Trouble analysis

1. Check temperature difference between intake and discharge air, and check for the operating current too.

Case	Symptom	Supposed Caused
Case 1	Temp. difference : approx. 0°C Current : less than 80% of rated current	All amount of refrigerant leaked out. Check refrigeration cycle.
Case 2	Temp. difference : approx. 8°C Current : less than 80% of rated current	Refrigerant leakage Clog of refrigeration cycle Defective Compressor.
Case 3	Temp. difference : less than 8°C Current : over the rated current	Excessive amount of refrigerant
Case 4	Temp. difference : over 8°C	Normal

### NOTICE

Temperature difference between intake and discharge air depends on room air humidity. When the room air humidity is relatively higher, temperature difference is smaller. When the room air humidity is relatively lower temperature difference is larger.

2. Check temperature and pressure of refrigeration cycle in cooling mode.

Suction pressure (Compared with the normal value)	Temperature of Discharge Air (Compared with the normal valve)	Cause of Trouble	Description
Higher	High	Defective compressor Defective 4-way reverse valve	Current is low.
	Normal	Excessive amount of refrigerant	High pressure does not quickly rise at the beginning of operation.
Lower	Higher	Insufficient amount of refrigerant (Leakage) Clogging	Current is low.

### NOTICE

1. The suction pressure is usually 8.5~9.5kg/cm<sup>2</sup>G(Cooling) at normal condition.(R410A)
2. The temperature can be measured by attaching the thermometer to the low pressure tubing and wrap it with putty.

## 6. Electronic Parts

### 6.1 The Product doesn't operate at all

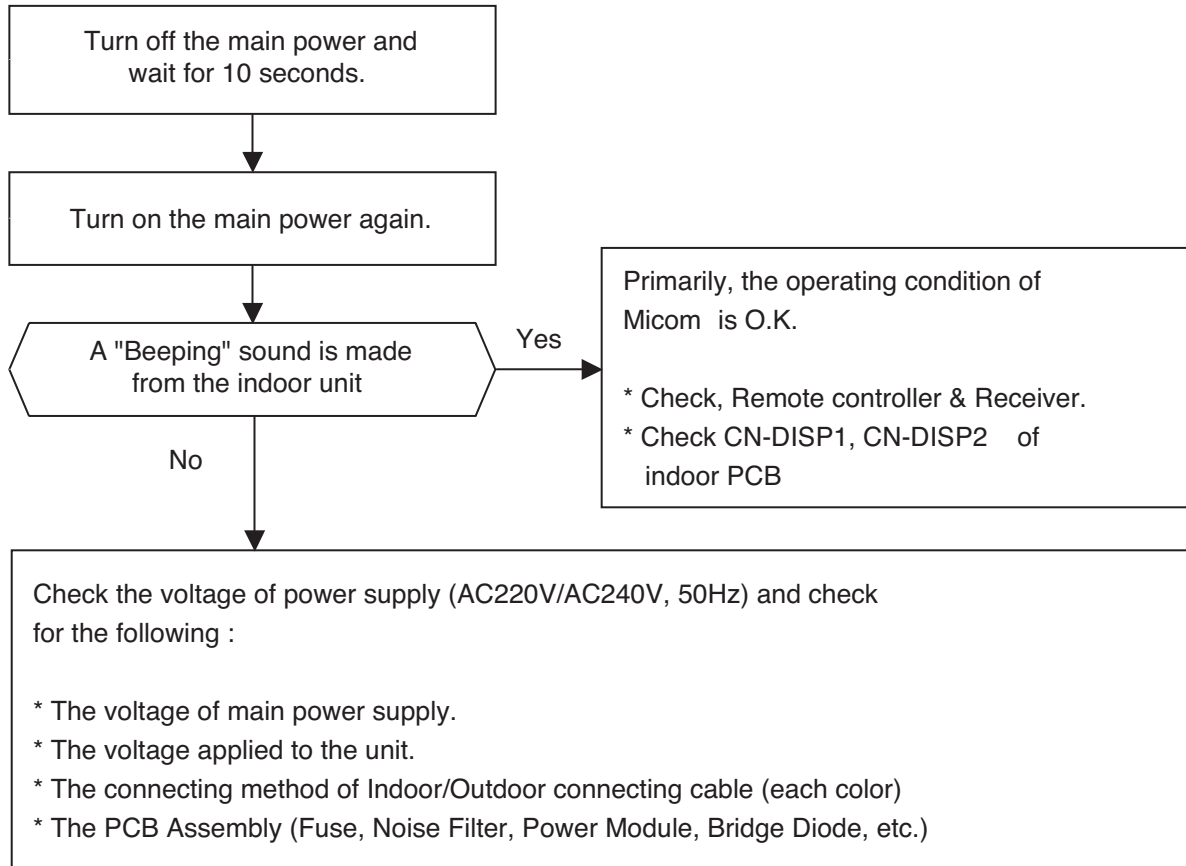

The operation check of the Indoor PCB Assembly		
Procedure	Specification	Remedy
1) The input voltage of power module.	1) AC230V $\pm$ 30V : Check the rated voltage	1) Check the power outlet.
2) The output voltage of power module.	2) 12V $\pm$ 3V	2) Replace PCB Assembly
4) IC04D(7805)	4) DC5V	4) Replace PCB Assembly
5) IC01A(KIA7036)	5) The voltage of micom pin 19 : DC4.5V $\uparrow$	5) Replace PCB Assembly



## 6.2 The Product doesn't operate with the remote controller

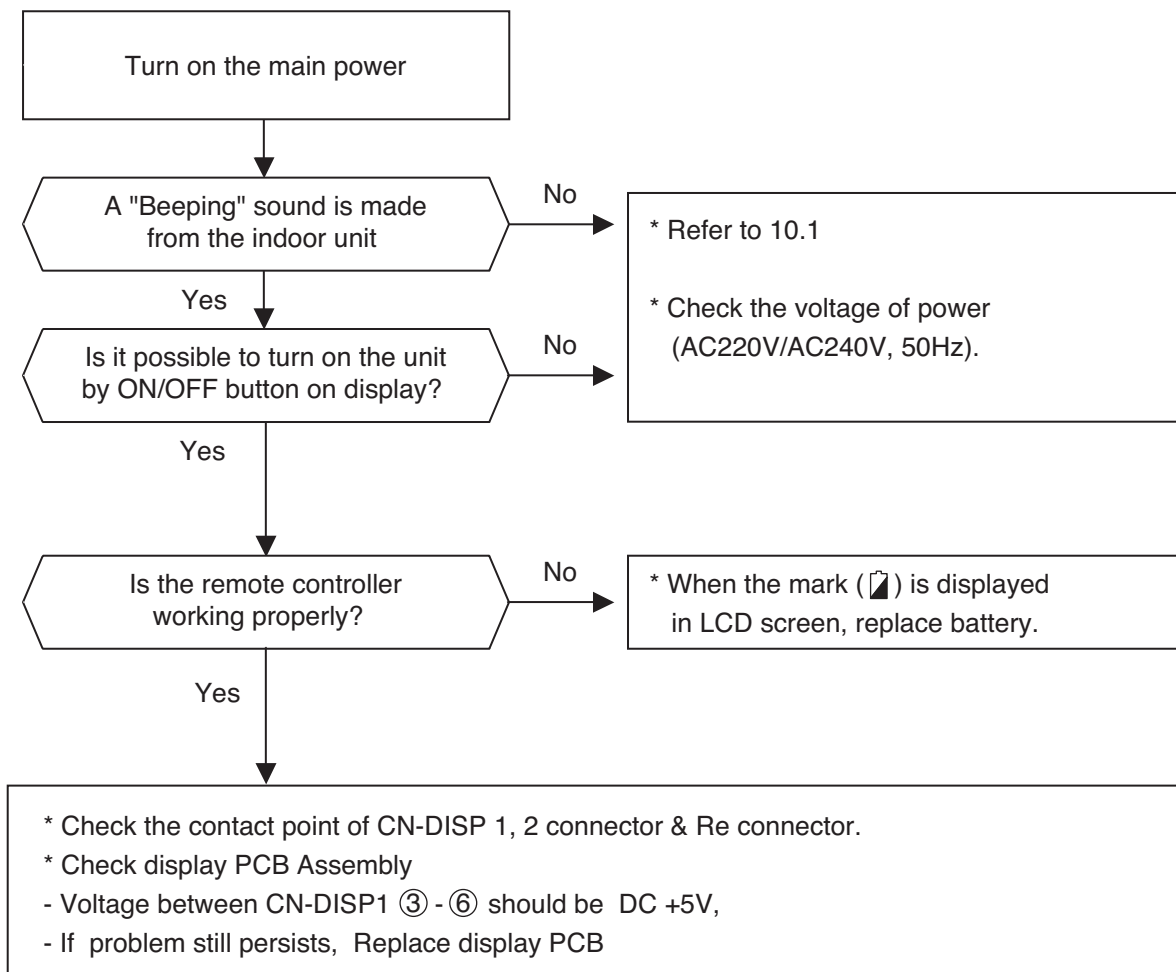

### 6.3 The Compressor/Outdoor Fan are don't operate

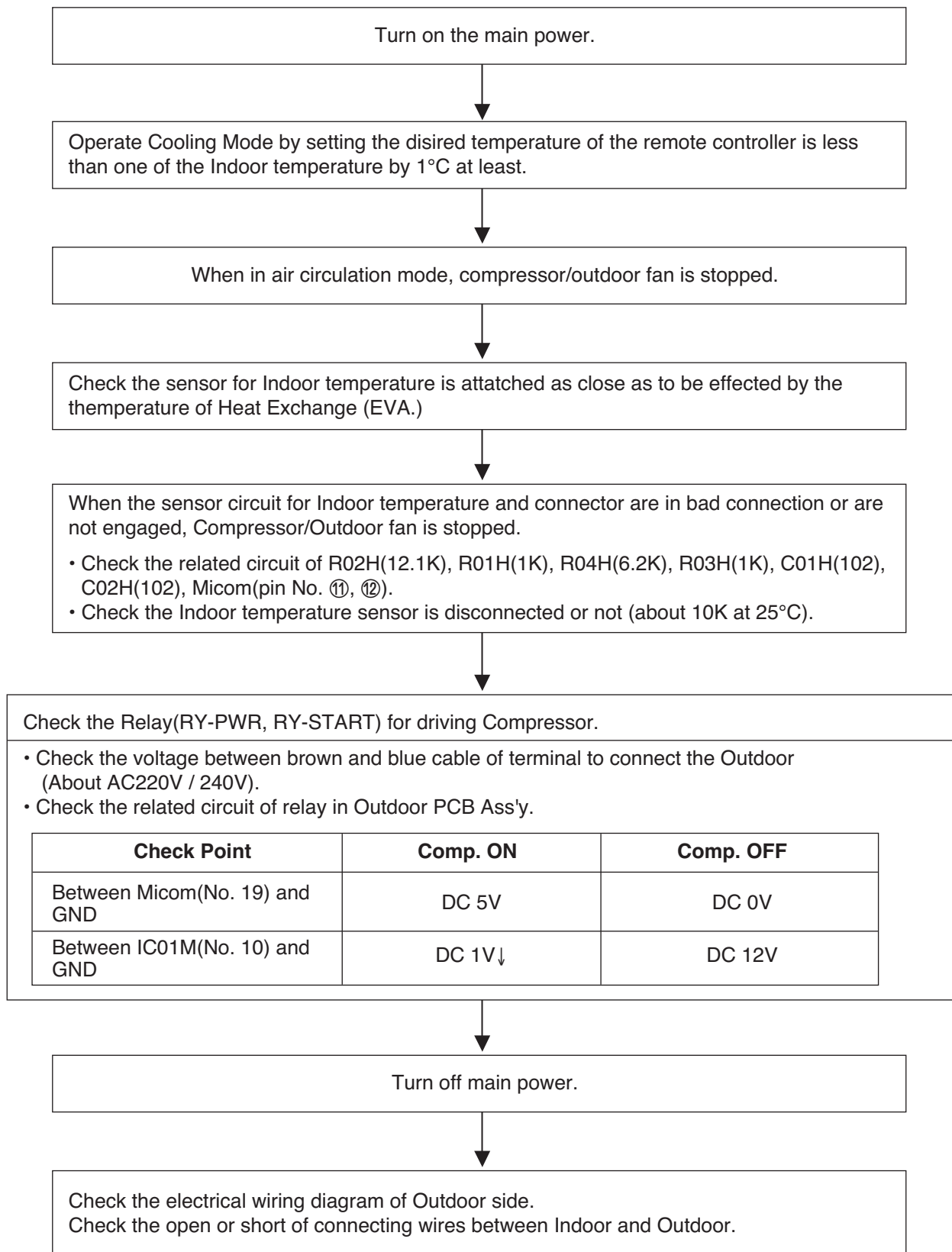

### 6.4 When indoor Fan does not operate.

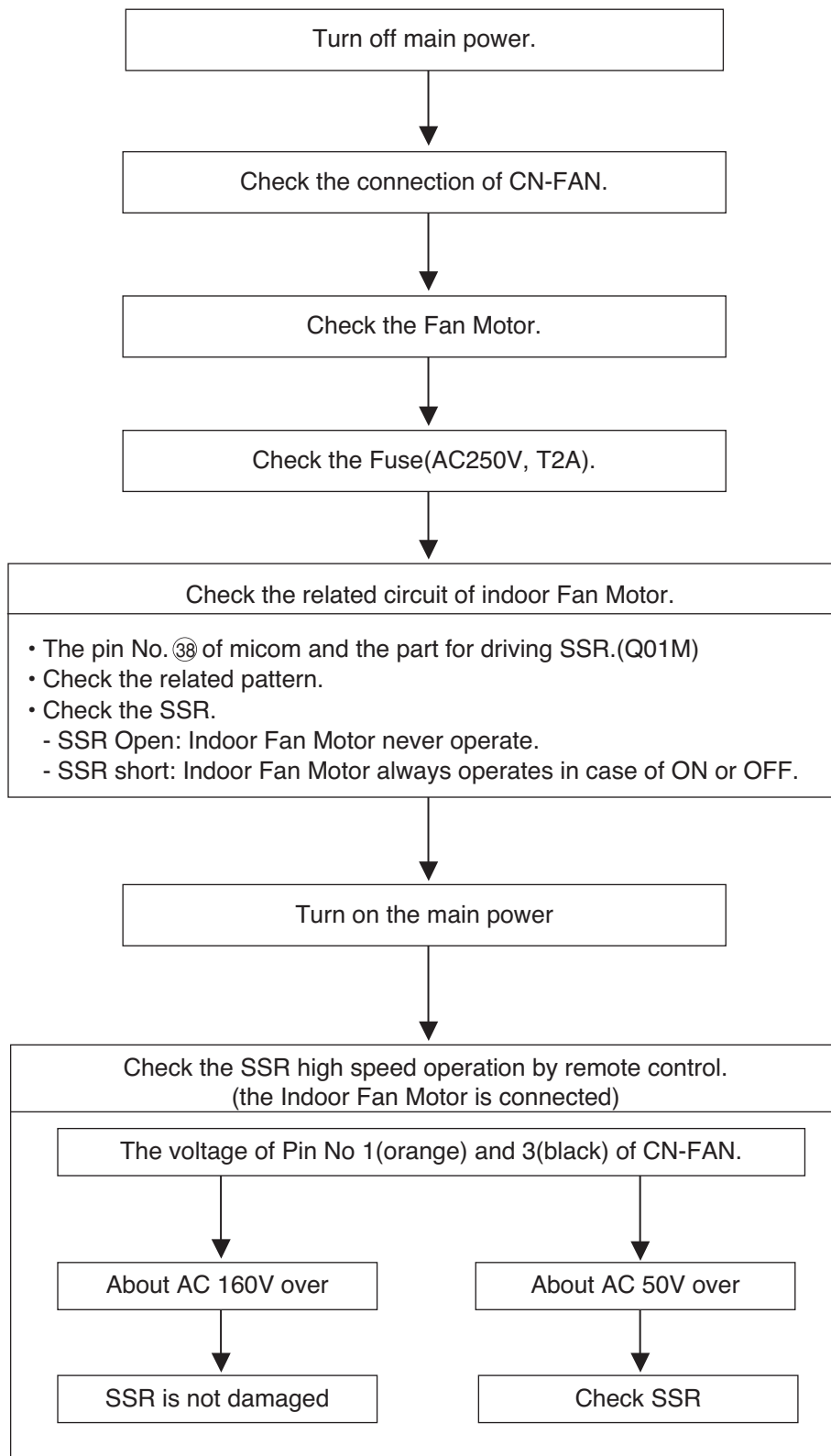

## 6.5 When the louver does not operate.

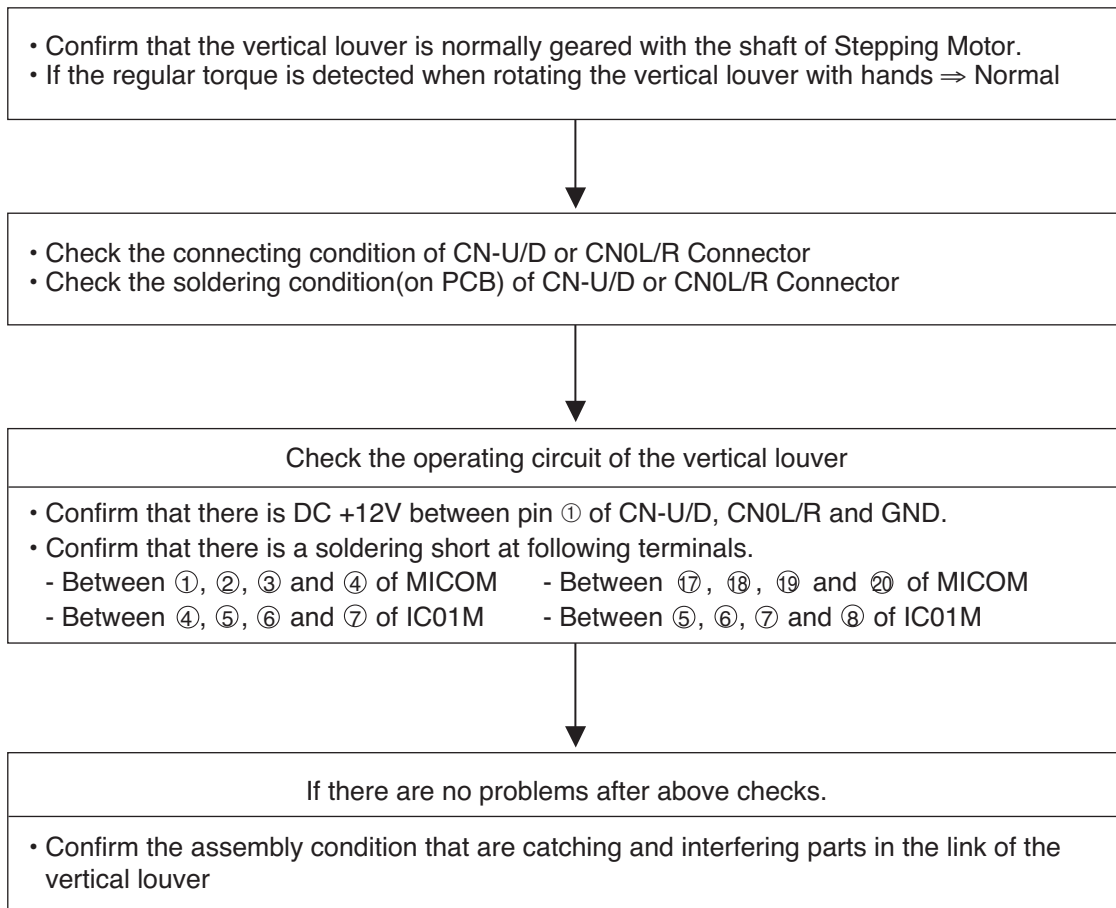

## 6.6 Troubleshooting Indoor Error

Display code	Title	Cause of error	Check point & Normal condition
01	Indoor air sensor	<ul style="list-style-type: none"> <li>• Connector connection error</li> <li>• Faulty PCB</li> <li>• Faulty sensor (Open / Short)</li> </ul>	Normal resistor : 10KΩ/ at 25°C (Unplugged) Normal voltage : 2.5Vdc / at 25°C(Plugged) Refer to sensor resistance table.
02	Indoor inlet pipe sensor	<ul style="list-style-type: none"> <li>• Connector connection error</li> <li>• Faulty PCB</li> <li>• Faulty sensor (Open / Short)</li> </ul>	Normal resistor : 5KΩ/ at 25°C(Unplugged) Normal voltage : 2.5Vdc / at 25°C(Plugged) Refer to sensor resistance table.
06	Indoor outlet pipe sensor	<ul style="list-style-type: none"> <li>• Connector connection error</li> <li>• Faulty PCB</li> <li>• Faulty sensor (Open / Short)</li> </ul>	Normal resistor : 5KΩ/ at 25°C(Unplugged) Normal voltage : 2.5Vdc / at 25°C(Plugged) Refer to sensor resistance table.

### Check Flow Chart

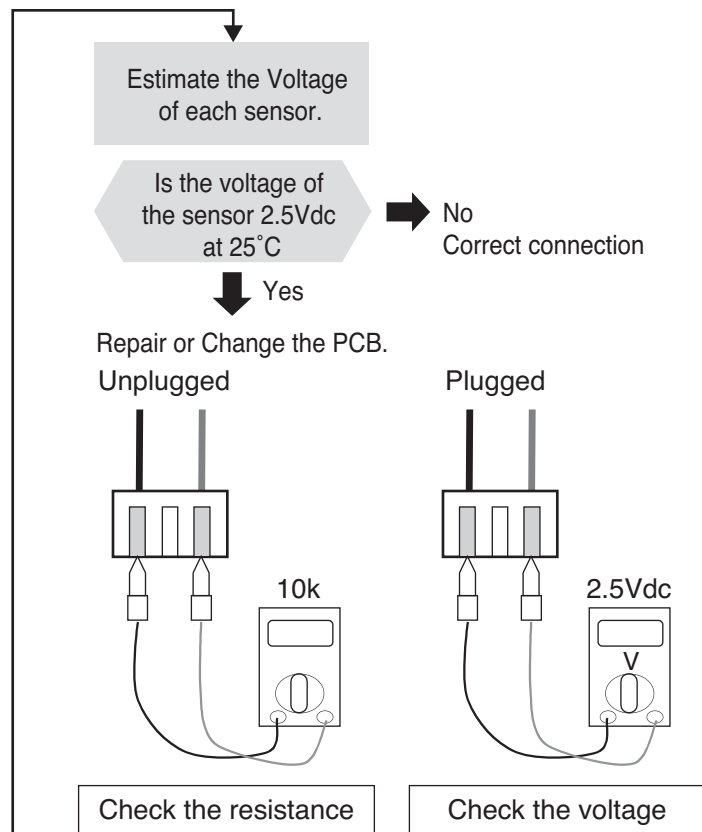
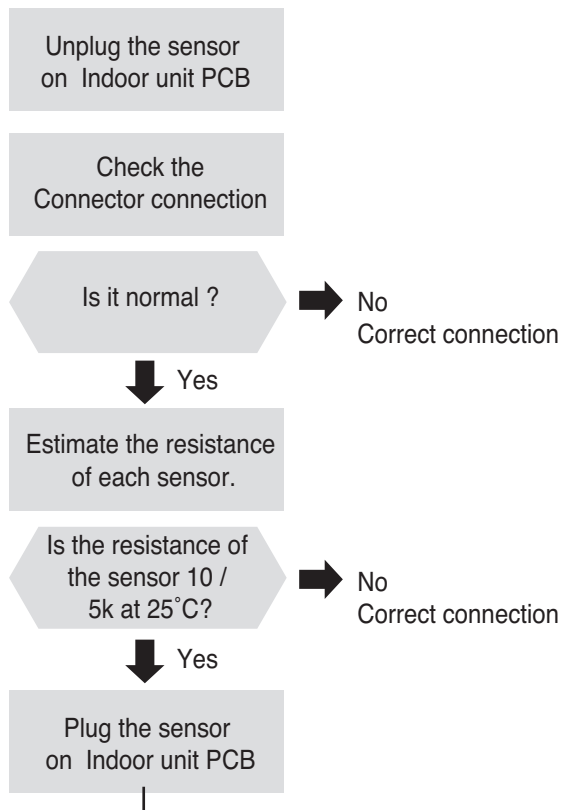

### Check Point

1. Unplug the sensor on Indoor unit PCB.
2. Estimate the resistance of each sensor.
3. If the resistance of the sensor is 10KΩ/ 5KΩ at 25°C, then sensor is normal.
4. If the resistance of the sensor is 0 KΩ or ∞, then sensor is abnormal. → Change the sensor.
5. Plug the sensor on Indoor unit PCB and Power ON.
6. Estimate the voltage of each sensor.
7. If the voltage of the sensor is 2.5Vdc at 25°C, then sensor is normal.
8. If the resistance of the sensor is 0 or 5Vdc, then sensor is abnormal. → Repair or Change the PCB.

Display code	Title	Cause of error	Check point & Normal condition
03	Communication Error (Wired remote controller)	<ul style="list-style-type: none"> <li>• Connector connection error</li> <li>• Faulty PCB / Remote controller</li> <li>• Connection wire break</li> </ul>	<ul style="list-style-type: none"> <li>• Connection of wire</li> <li>• Main PCB Volt. DC12V</li> <li>• Noise interference</li> </ul>

### Check Flow Chart

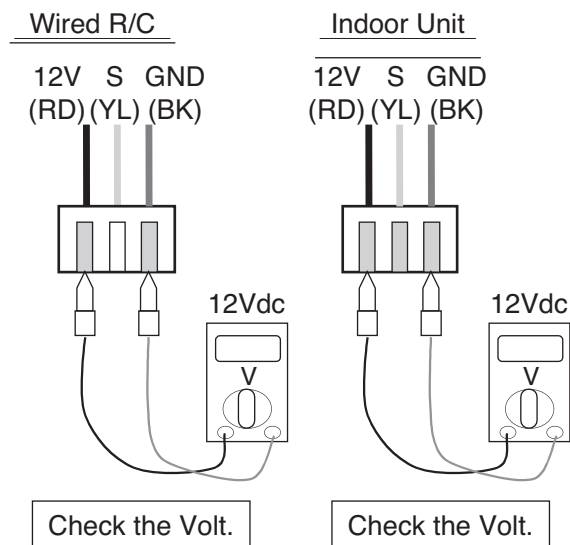
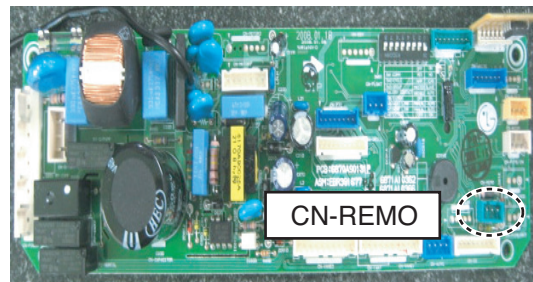
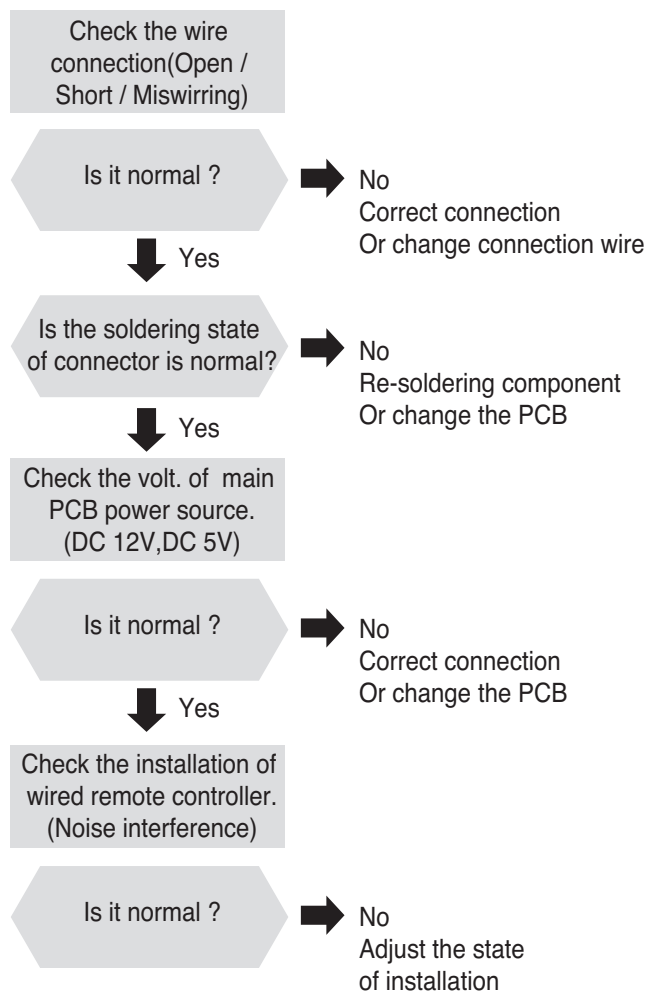

### Check Point

1. Check the wire connection. (Open / Short) → Repair the connection
2. Check the soldering state of connector. (Soldered poorly) → Repair or Change the PCB.
3. Check the volt. Of main PCB power source. (DC 12V) → Repair or Change the main PCB.
4. Check the installation of wired remote controller. (Noise interference) → Adjust the state of installation

Display code	Title	Cause of error	Check point & Normal condition
04	Drain pump / Float switch	<ul style="list-style-type: none"> <li>• Float switch open. (Normal : short)</li> <li>• Water over flow</li> </ul>	<ul style="list-style-type: none"> <li>• The connection of wire (Drain pump/ Float switch)</li> <li>• Drain pump power input. (220V)</li> <li>• Drain tube installation.</li> <li>• Indoor unit installation. (Inclination)</li> </ul>

**Check Flow Chart**

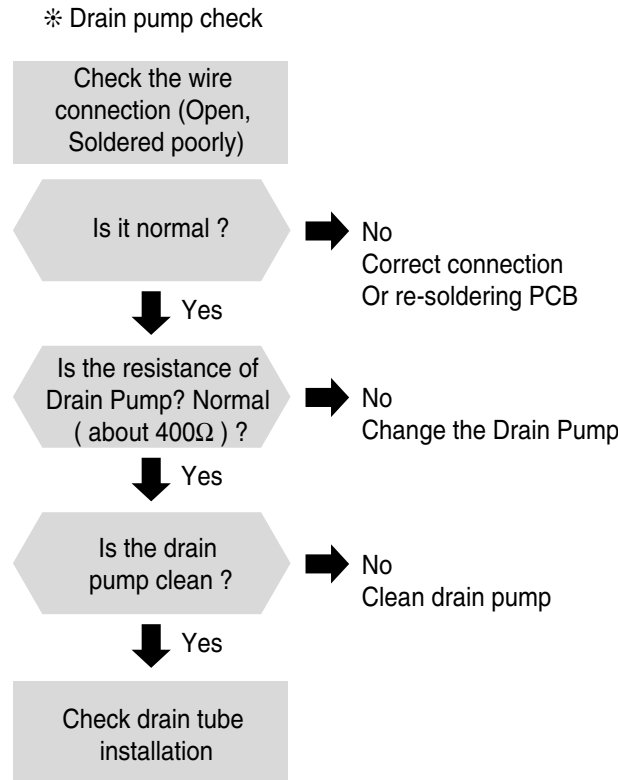
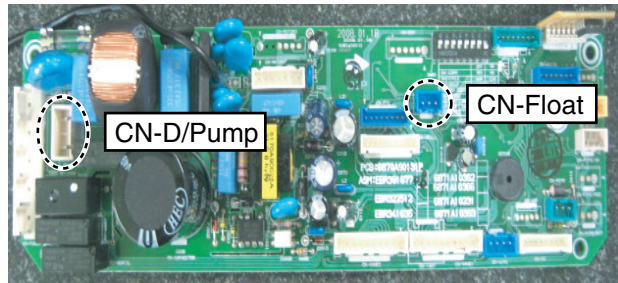
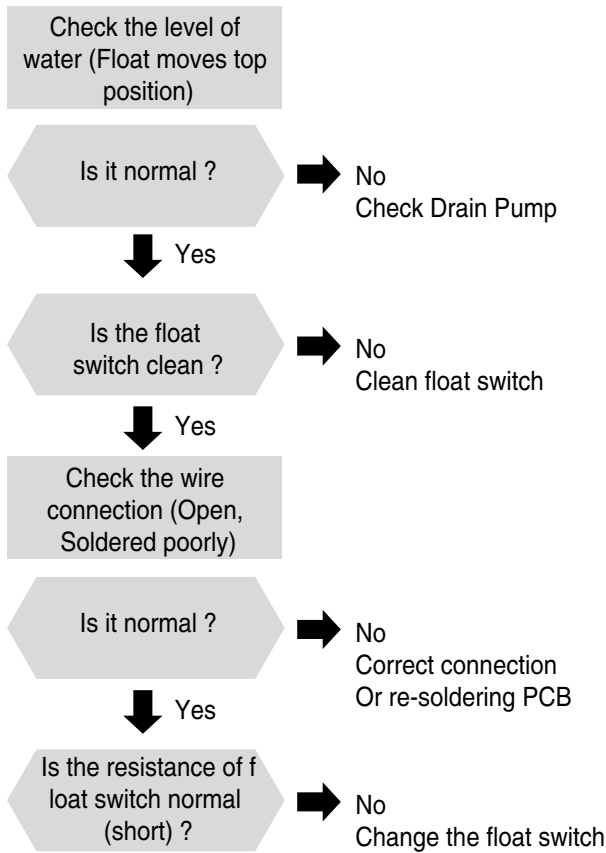

**Check Point**

1. Check the wire connection. (Open, Soldered poorly) → Repair the connection or change the PCB.
2. Check the resistance of float switch (Abnormal : Open, Normal : short) → Check the float switch.
3. Check the level of water
4. Check the volt. Of Drain pump power supply. (AC 230V) → Repair or Change the main PCB.

Display code	Title	Cause of error	Check point & Normal condition
09	Indoor EEPROM Check Sum Error	• Check sum error	1. Check the poor soldering 2. Check the insertion condition of the EEPROM 3. Check the PCB Connection

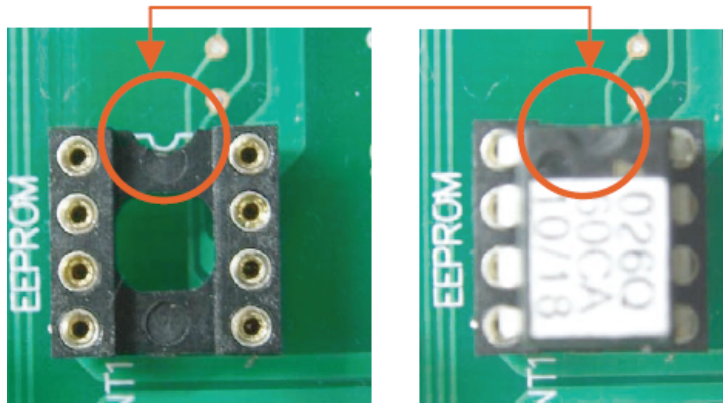

&lt;EEPROM Direction Check Point&gt;

### Check Point

1. Check the EEPROM Direction
2. If the EEPROM value & the Program value are not matched, the Code is Displayed
3. After Checking the connection and Insertion, replace the PCB or Option PCB



## 4. Trouble Shooting

Display code	Title	Cause of error	Check point & Normal condition
10	Indoor BLDC Fan Motor Lock	The Fan is not operated properly	Check the Indoor fan locking

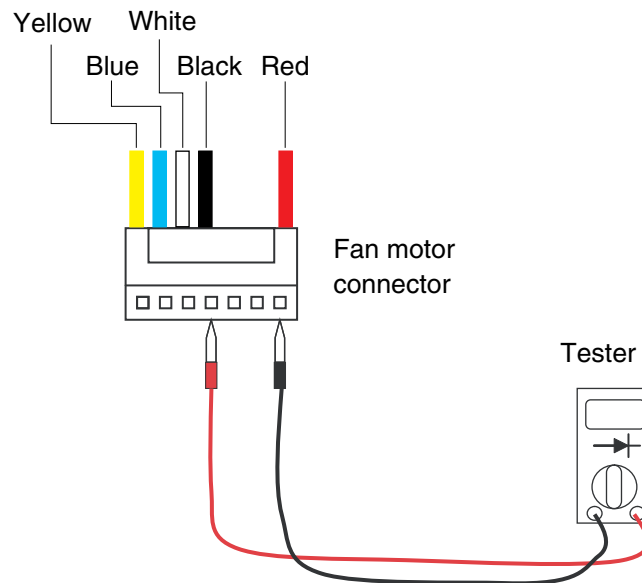

### Check Point

Check the PCB during the Power on

1. Check the Voltage Red line to Black line
  - The Voltage is about [input voltage x 1.414]
  - if the Voltage does not come with the above Voltage,
  - Check the power input
  - Replace the PCB & Motor
2. Check the Voltage Black line to White
  - the Voltage is DC 15V
  - Check the Power input
  - Replace the motor

Check the Motor

1. Check the shaft
  - if the shaft is not turn smoothly, the Motor Power IC is defected
  - replace the motor
2. Check the motor resistance(if the shaft is turn smoothly, check the resistance)
  - Check Red line to Black line, Blue line to Black line
  - The resistance should infinite
  - replace the motor

Display code	Title	Cause of error	Check point & Normal condition
05 / 53	Communication (Indoor↔Outdoor)	<ul style="list-style-type: none"> <li>• The connector for transmission is disconnected.</li> <li>• The connecting wires are misconnected.</li> <li>• The communication line is break</li> <li>• Outdoor PCB is abnormal.</li> <li>• Indoor PCB is abnormal.</li> <li>• Synchro # of IDU is abnormal.</li> </ul>	<ul style="list-style-type: none"> <li>• Check power input AC 230V. (Outdoor, Indoor)</li> <li>• Check connector for transmission</li> <li>• Check wires are misconnecting.</li> <li>• Check transmission circuit of outdoor PCB</li> <li>• Check transmission circuit of indoor PCB</li> <li>• Check # of IDU setting DIP SW</li> </ul>

**Check Flow Chart**

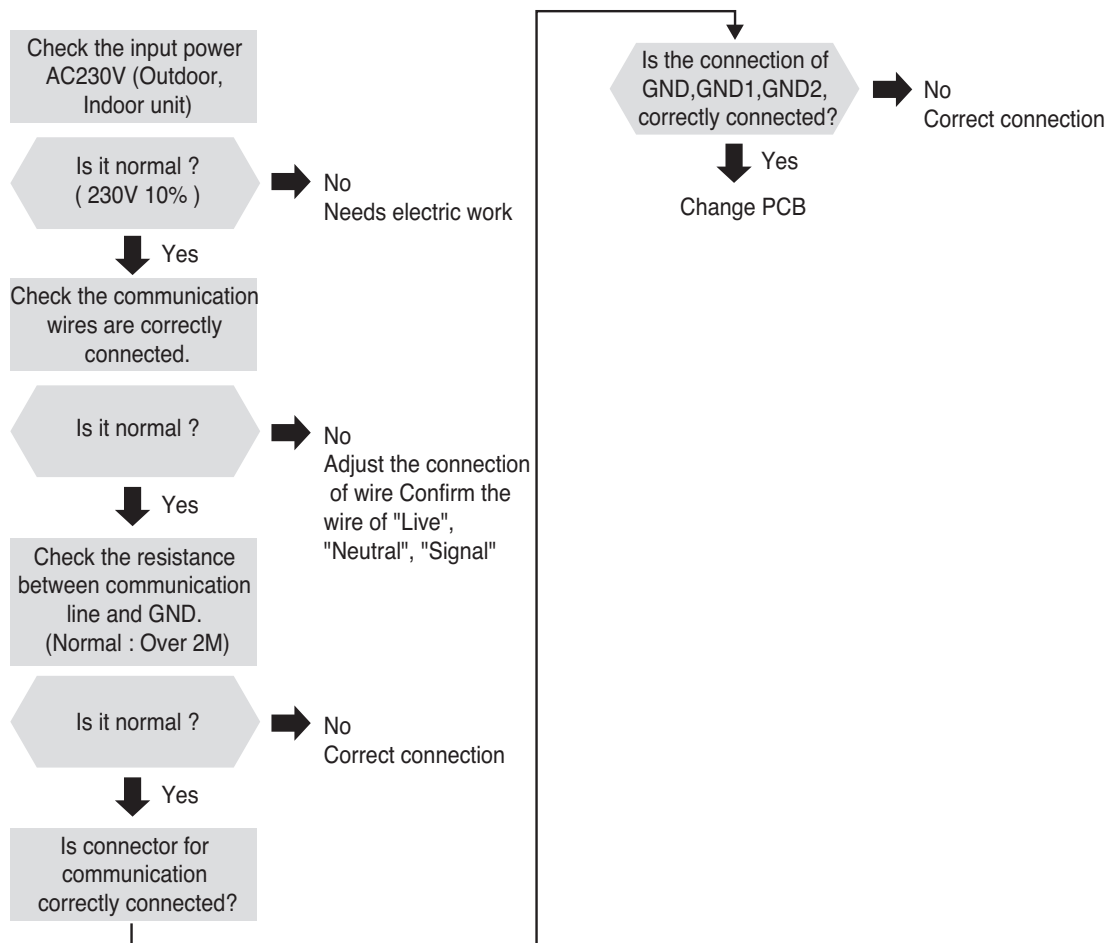

## 6.9 Troubleshooting Outdoor Error

Display code	Title	Cause of error	Check point & Normal condition
21	DC PEAK (IPM Fault)	<ul style="list-style-type: none"> <li>Instant over current</li> <li>Over Rated current</li> <li>Poor insulation of IPM</li> </ul>	<ul style="list-style-type: none"> <li>An instant over current in the U,V,W phase                             <ul style="list-style-type: none"> <li>Comp lock</li> <li>The abnormal connection of U,V,W</li> </ul> </li> <li>Over load condition                             <ul style="list-style-type: none"> <li>Overcharging of refrigerant Pipe length.</li> <li>Outdoor Fan is stop</li> </ul> </li> <li>Poor insulation of compressor</li> </ul>



### WARNING

Before checking PCB or each outdoor electric parts, wait for 3 minutes after the power is off. When measuring at standby state of power supply, after checking the measurement mode of the meter, be careful of the short-circuits with other parts.

### ■ Error Diagnosis and Countermeasure Flow Chart

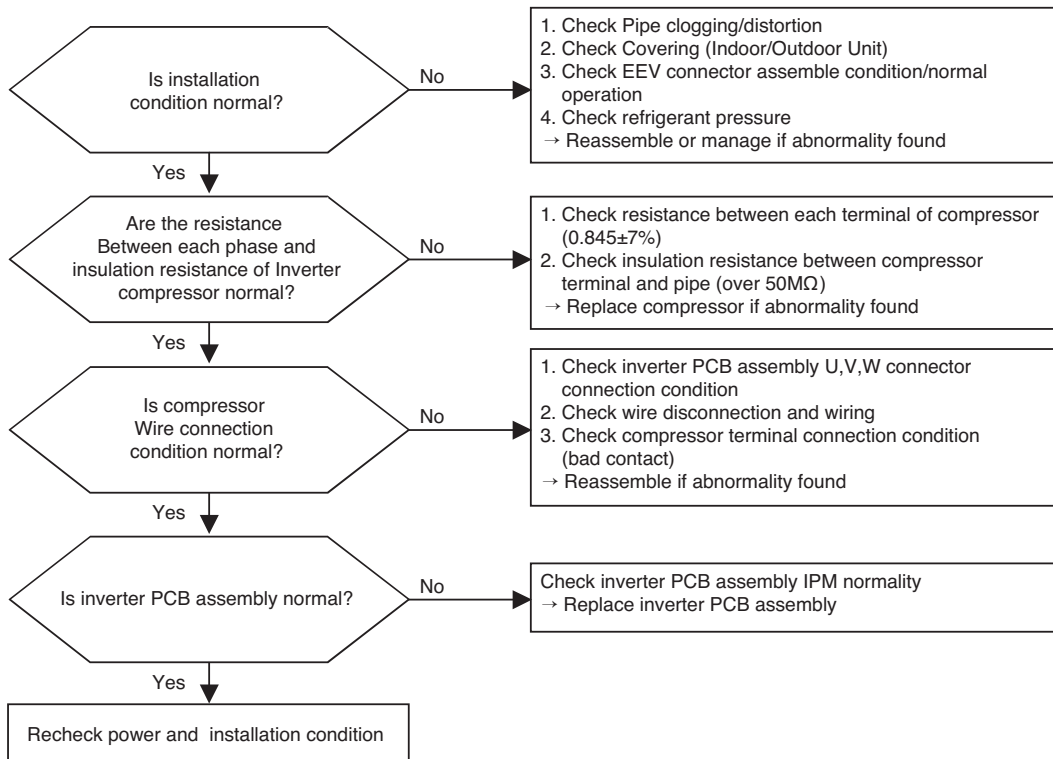

### ■ Comp checking method

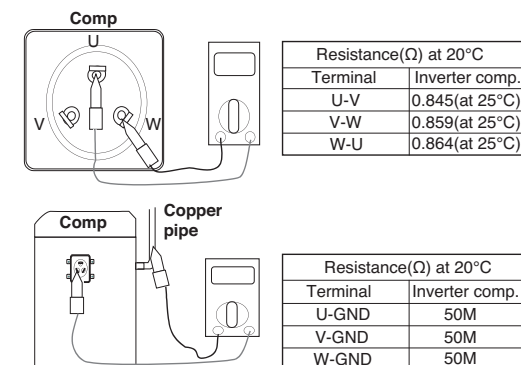

■ UU37W / UU43W / UU49W / UU61W

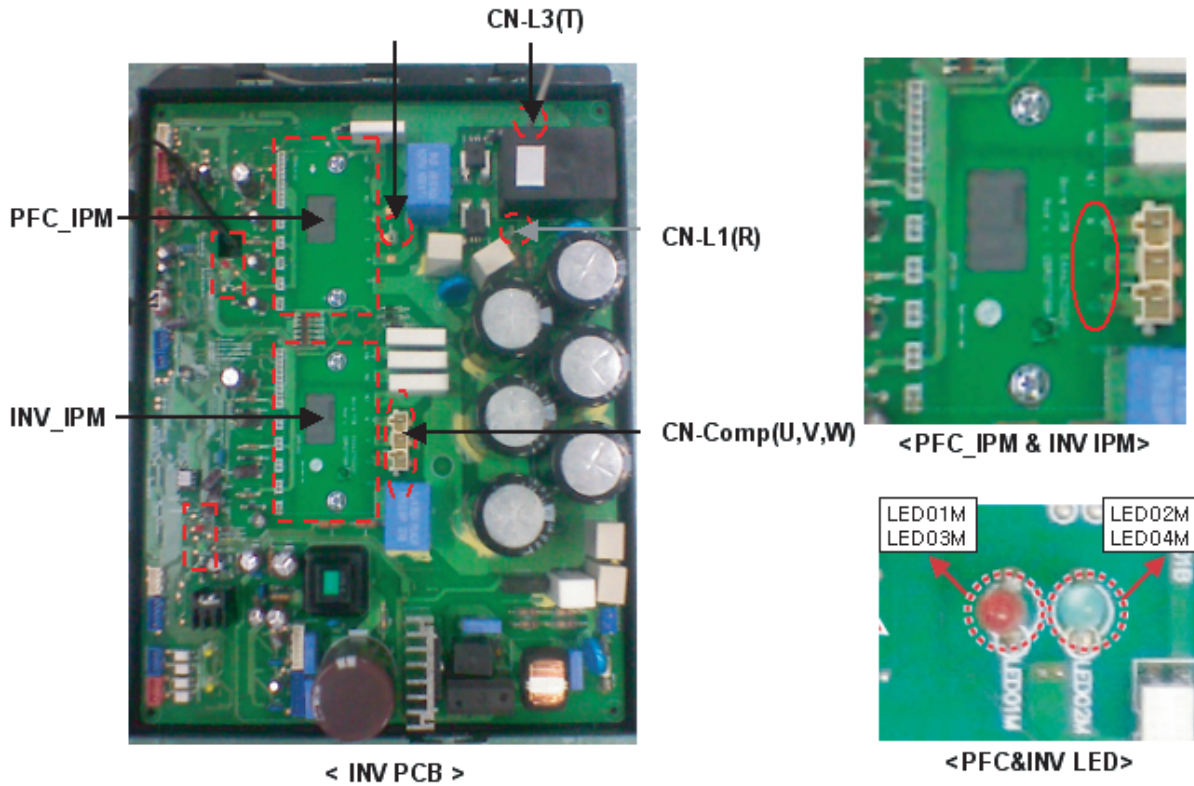

1. Wait until inverter PCB DC voltage is discharged after main power off.
2. Pull out CN-L1(R), CN-L2(S), CN-L3(T) and CN-COMP Connector.
3. Set multi tester to resistance mode.
4. If the value between P and N terminal of IPM is short( $0\Omega$ ) or open(hundreds  $M\Omega$ ), PCB needs to be replaced.(IPM damaged)
5. Set the multi tester to diode mode.
6. In case measured value is different from the table, PCB needs to be replaced.(PCB damaged).

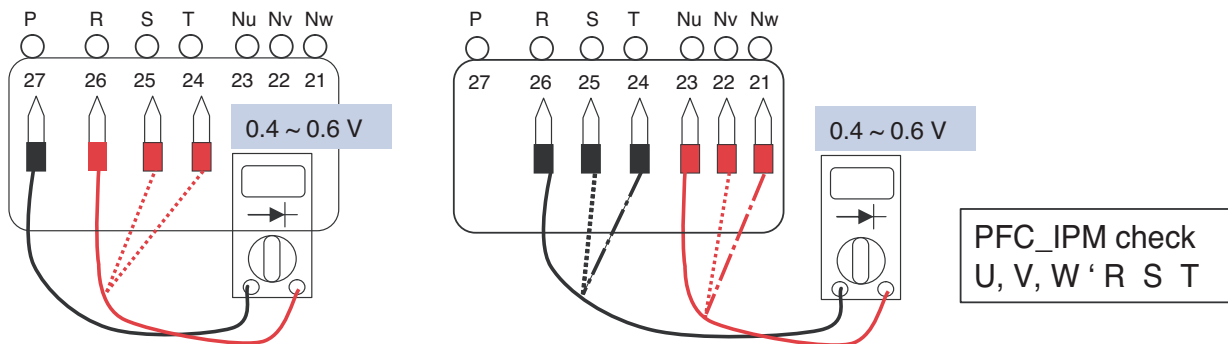

## 4. Trouble Shooting

Display code	Title	Cause of error	Check point & Normal condition
22	Max. C/T	Input Over Current	1. Malfunction of Compressor 2. Blocking of Pipe 3. Low Voltage Input 4. Refrigerant, Pipe length, Blocked...



### WARNING

Before checking PCB or each outdoor electric parts, wait for 3 minutes after the power is off. When measuring at standby state of power supply, after checking the measurement mode of the meter, be careful of the short-circuits with other parts.

### ■ Error Diagnosis and Countermeasure Flow Chart

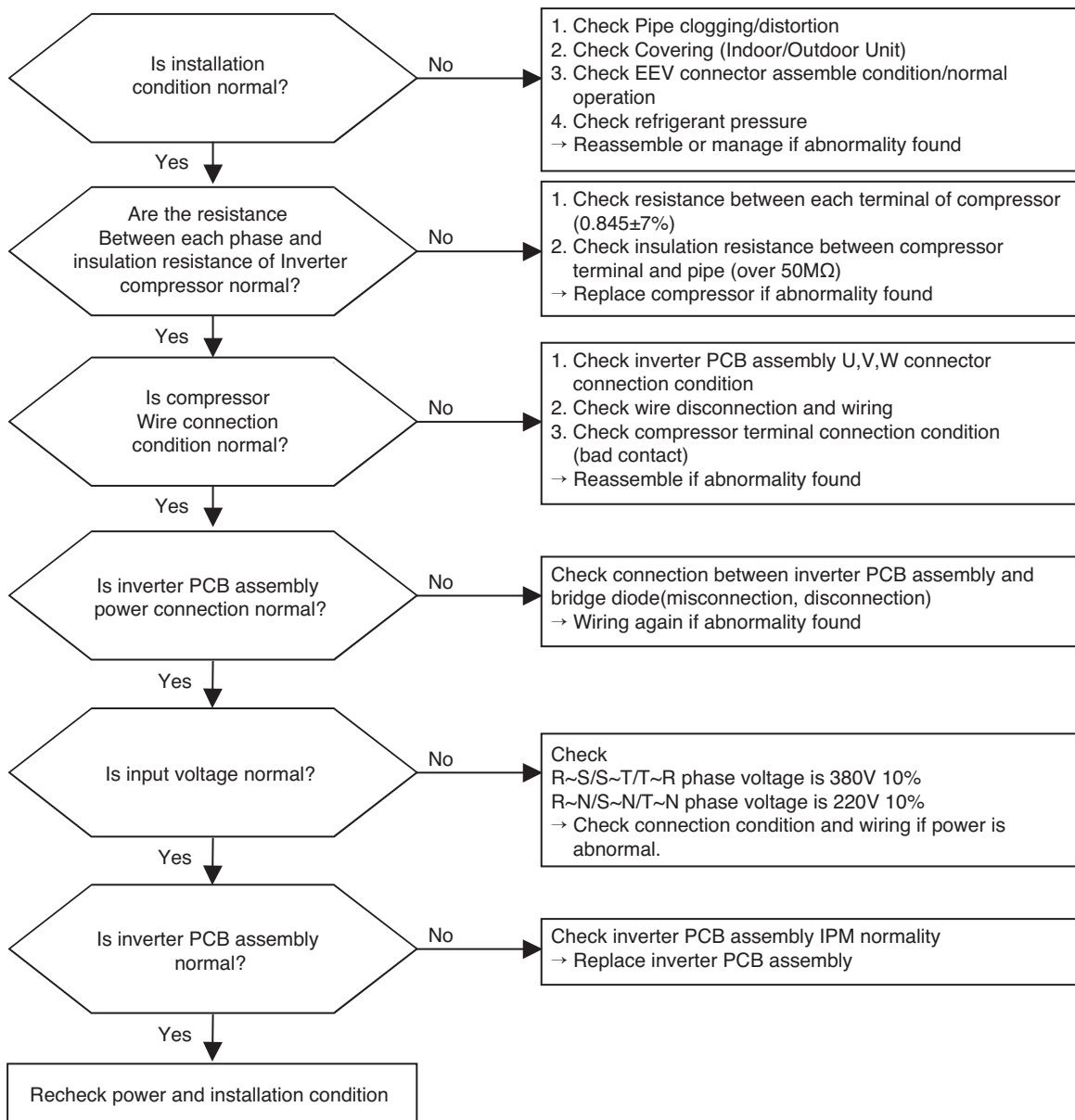

## Check Point

1. Check the power source.
2. Check the fan operation is right.
3. Check the current.
4. Check the install condition.
5. Check the CT Sensor Output signal (Check output pin 1.2 of the CT Sensor : 5V )

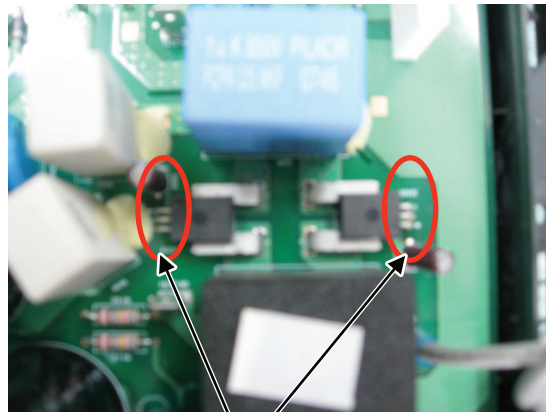
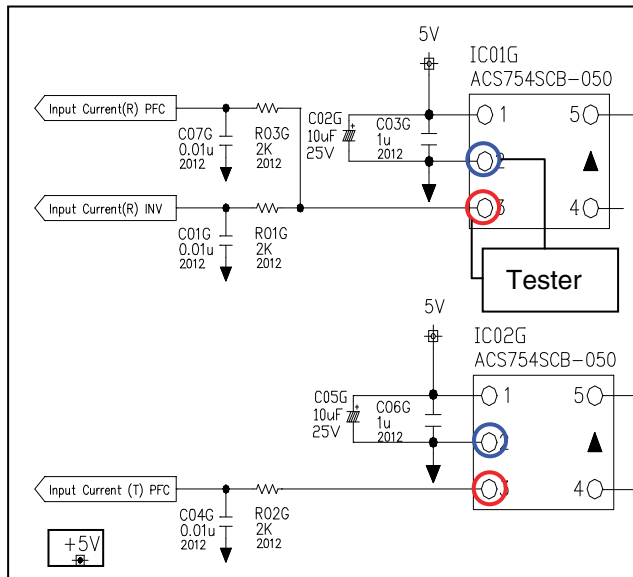

CT Sensor Output  
(at the INVERTER PCB)

## 4. Trouble Shooting

Display code	Title	Cause of error	Check point & Normal condition
23	DC Link High / Low Volt.	<ul style="list-style-type: none"> <li>• DC Link Voltage is above 780Vdc</li> <li>• DC Link Voltage is below 300Vdc</li> </ul>	<ul style="list-style-type: none"> <li>• Check point &amp; Normal condition</li> <li>• Check the TAB1 is connect.</li> <li>• At not operating : DC Link voltage(260V ↑ )</li> <li>• At Comp operating : DC Link voltage(500V ↑ )</li> </ul>

### ■ Error Diagnosis and Countermeasure Flow Chart

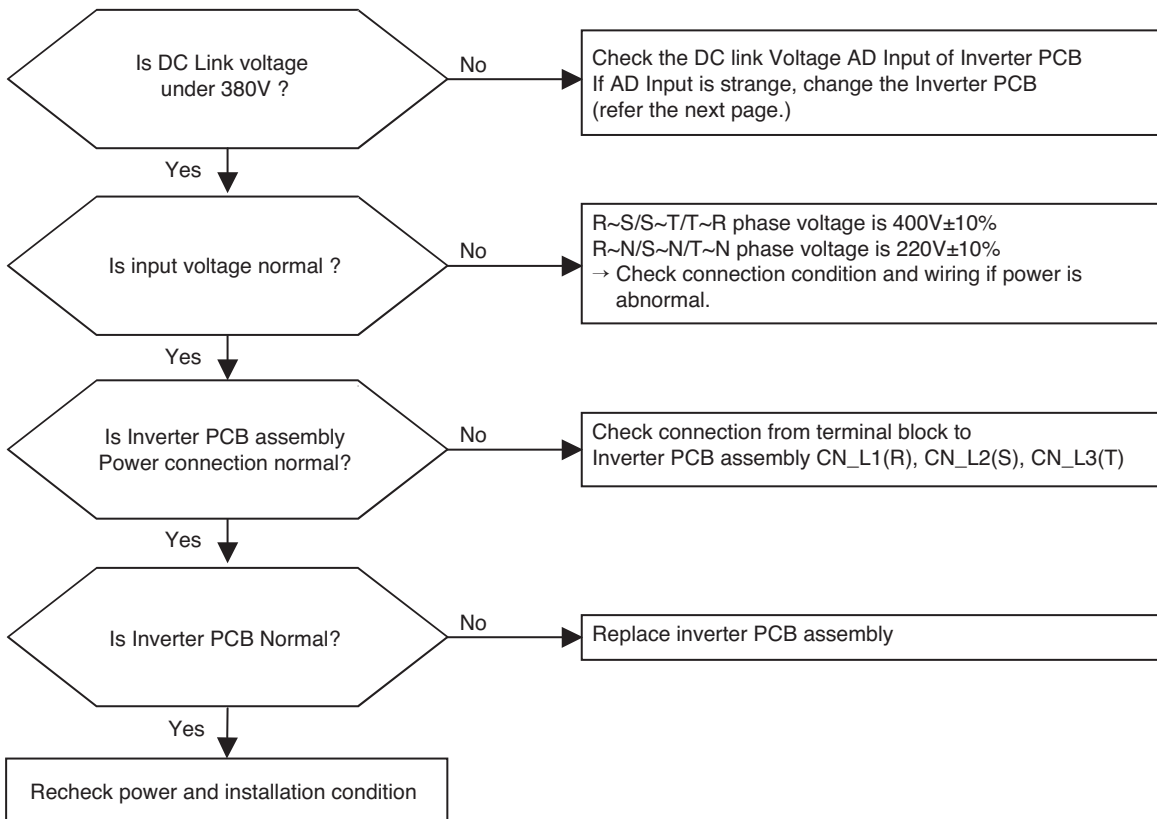

### Check Point

1. Check the Tab1 connection condition. (Refer to outdoor wiring diagram)
2. Check the CN\_L1(R), CN\_L2(S), CN\_L3(T) connection condition
3. Check the DC Link voltage at not operating(380V ↑)
4. Check the DC Link voltage at Comp operating(500V ↑)
5. Check DC Link Sensing Signal (Refer the Picture)

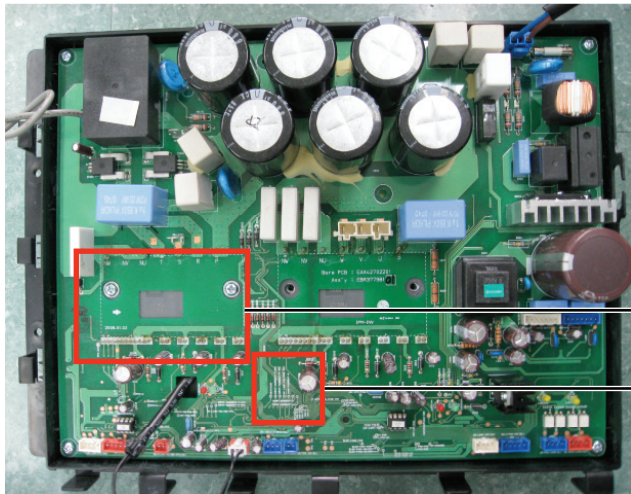

<INVERTER PCB>

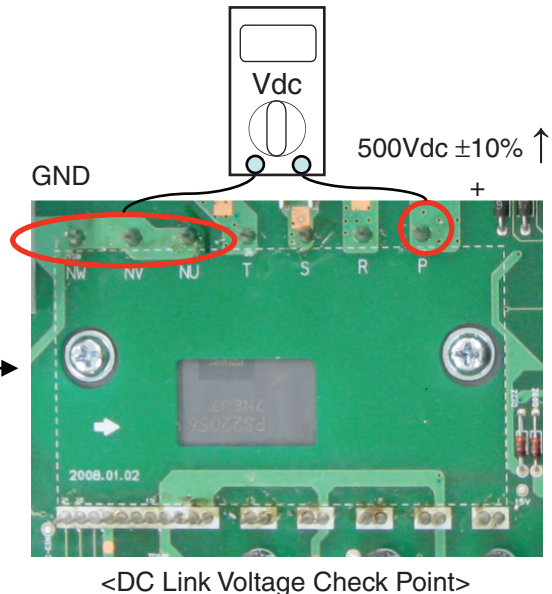

<DC Link Voltage Check Point>

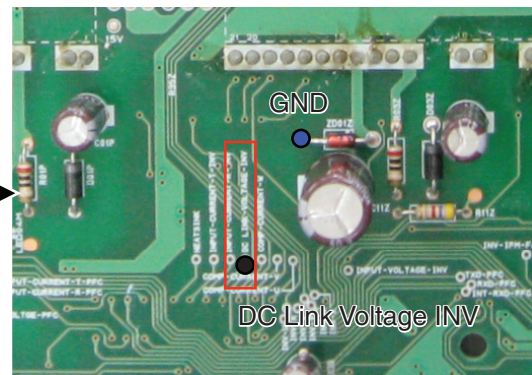
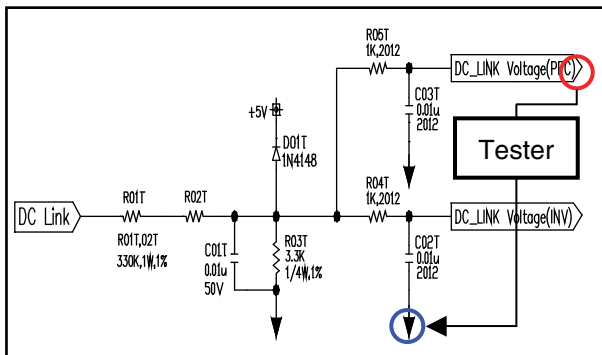

<INPUT VOLTAGE Check Point>



## 4. Trouble Shooting

Display code	Title	Cause of error	Check point & Normal condition
25	Input voltage	Abnomal Input Voltage (R,S,T -N /140Vac ↓ , 300Vac ↑ )	Check the power source. • Check the components.

### ■ Error Diagnosis and Countermeasure Flow Chart

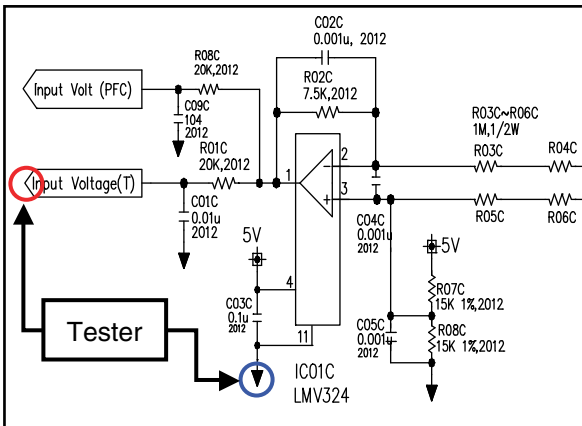
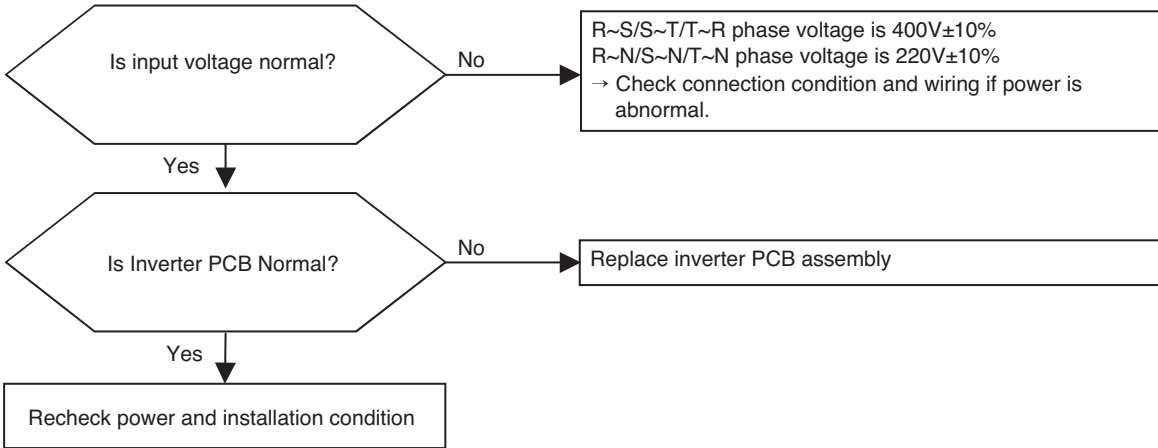

< CH25 Check Point >

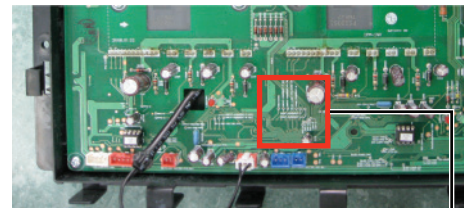

<INVERTER PCB>

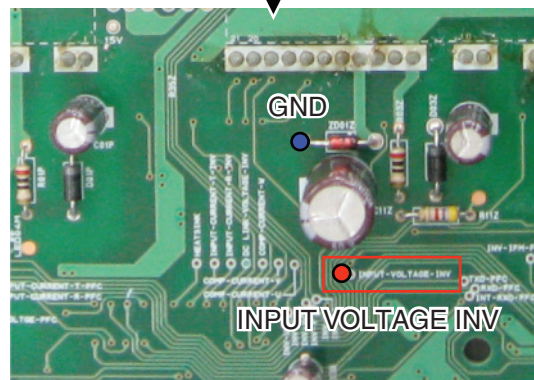

<INPUT VOLTAGE Check Point>

Display code	Title	Cause of error	Check point & Normal condition
26	DC Compressor Position	<ul style="list-style-type: none"> <li>Compressor Starting fail error</li> </ul>	<ul style="list-style-type: none"> <li>Check the connection of comp wire "U,V,W"</li> <li>Malfunction of compressor</li> <li>Check the component of "IPM", detection parts.</li> </ul>

### ■ Error Diagnosis and Countermeasure Flow Chart

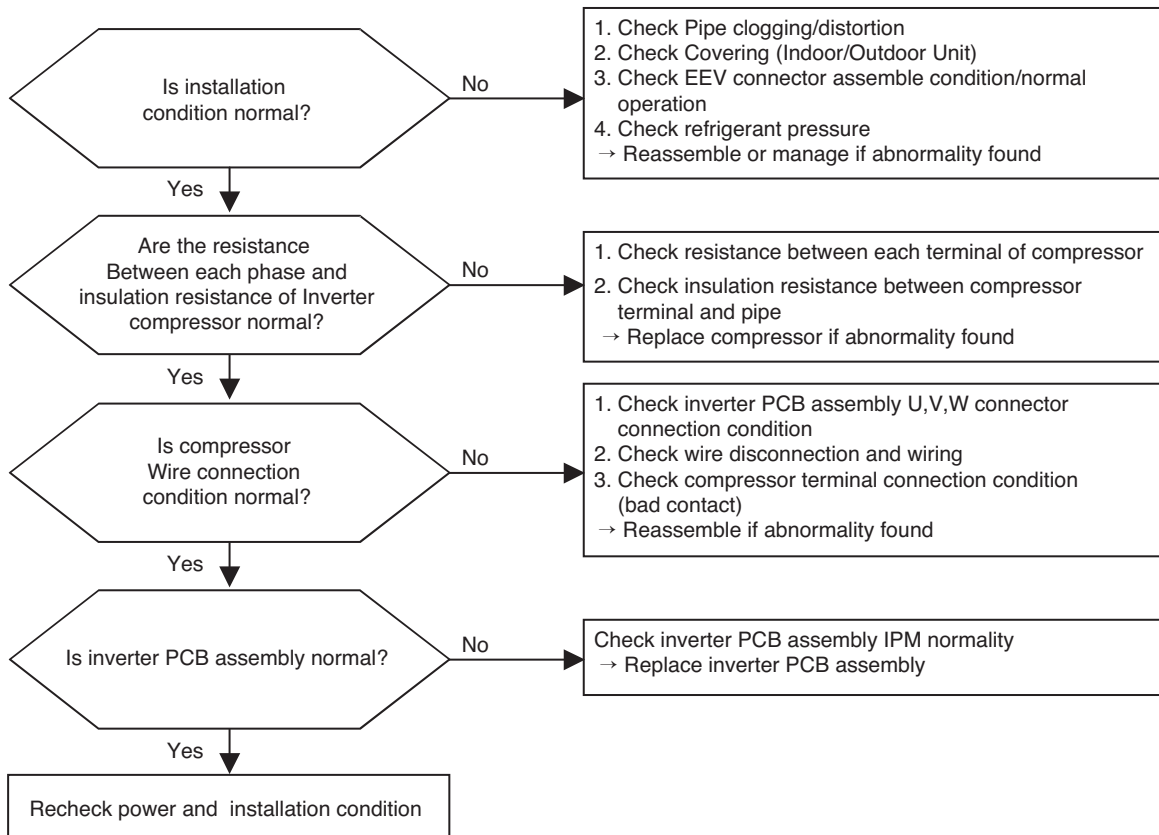

### Check Point

1. Check the connection condition of PCB.
2. Check the connection condition of Comp. U,V,W wire.
3. Check the comp resistor and insulation resistance .
4. Check the IPM.(Refer 106 page)
5. Check the pressure of refrigerant.
6. Check the Service Valve Open.

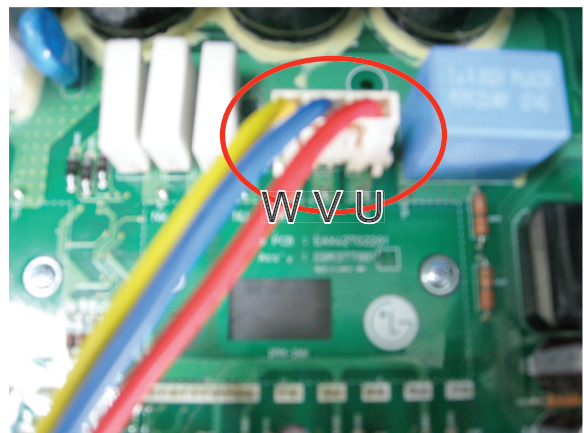

## 4. Trouble Shooting

Display code	Title	Cause of error	Check point & Normal condition
27	AC Input Instant over Current Error	Inverter PCB input current is over 100A(peak) for 2us	<ol style="list-style-type: none"> <li>1. Overload operation (Pipe clogging/Covering/EEV defect/Ref. overcharge)</li> <li>2. Compressor damage (Insulation damage/Motor damage)</li> <li>3. Input voltage abnormal (L,N)</li> <li>4. Power line assemble condition abnormal</li> <li>5. Inverter PCB assembly Damage (input current sensing part)</li> </ol>



### WARNING

Before checking PCB or each outdoor electric parts, wait for 3 minutes after the power is off. When measuring at standby state of power supply, after checking the measurement mode of the meter, be careful of the short-circuits with other parts.

### ■ Error Diagnosis and Countermeasure Flow Chart

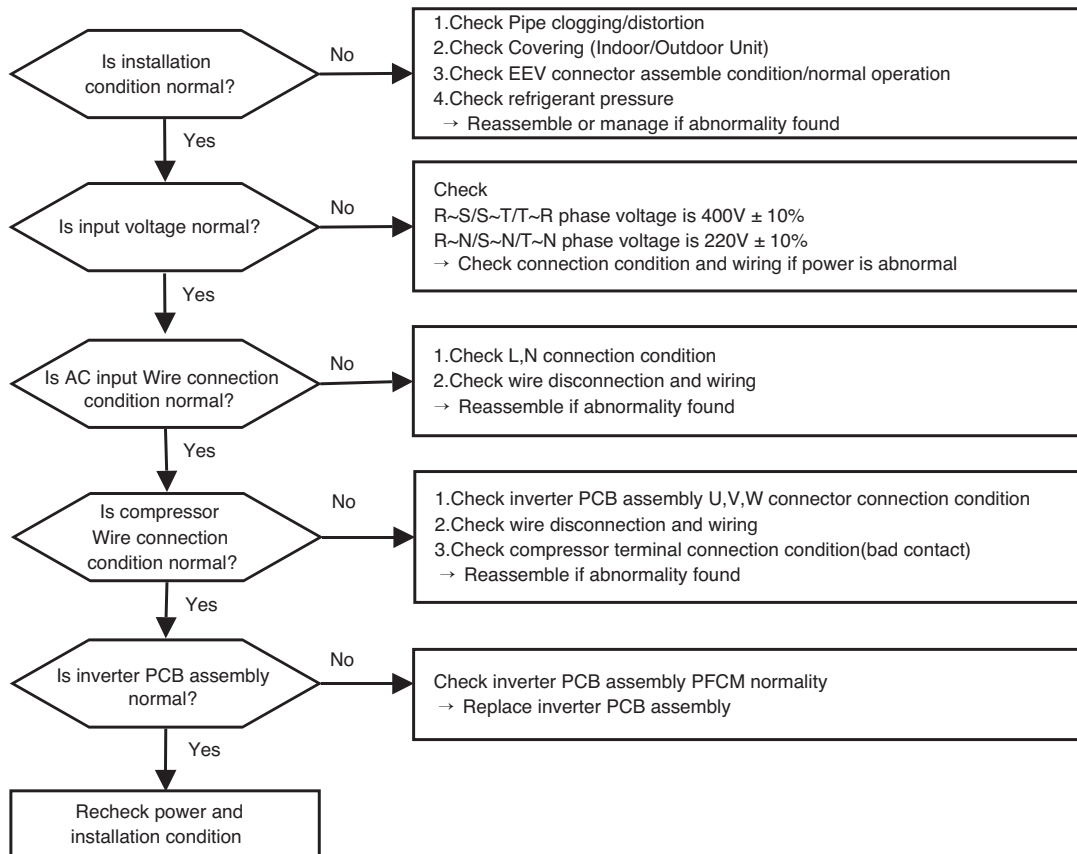

#### \* PFCM Module checking method

- ① Set the multi tester to diode mode.
- ② Check short between input signal pin which are placed below PFC Module
- ③ Replace PCB assembly if it is short between pins except No.4,5 pins.

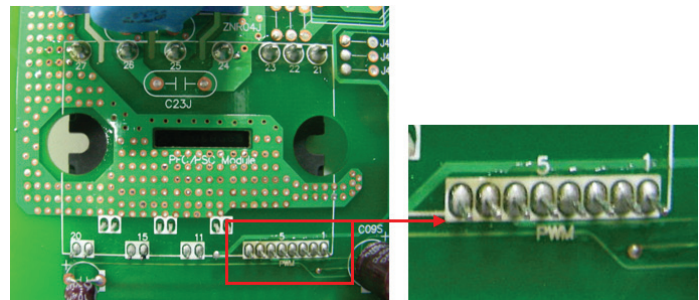

<Short Check Point>



### CAUTION

PFCM module No.4,5 pins are internal short state.

Display code	Title	Cause of error	Check point & Normal condition
29	Inverter compressor over current	Inverter compressor input current is over 30A	<ol style="list-style-type: none"> <li>1. Overload operation (Pipe clogging/Covering/EEV defect/Ref. over-charge)</li> <li>2. Compressor damage(Insulation damage/Motor damage)</li> <li>3. Input voltage low</li> <li>4. ODU inverter PCB assembly damage</li> </ol>

**WARNING**

Before checking PCB or each outdoor electric parts, wait for 3 minutes after the power is off. When measuring at standby state of power supply, after checking the measurement mode of the meter, be careful of the short-circuits with other parts.

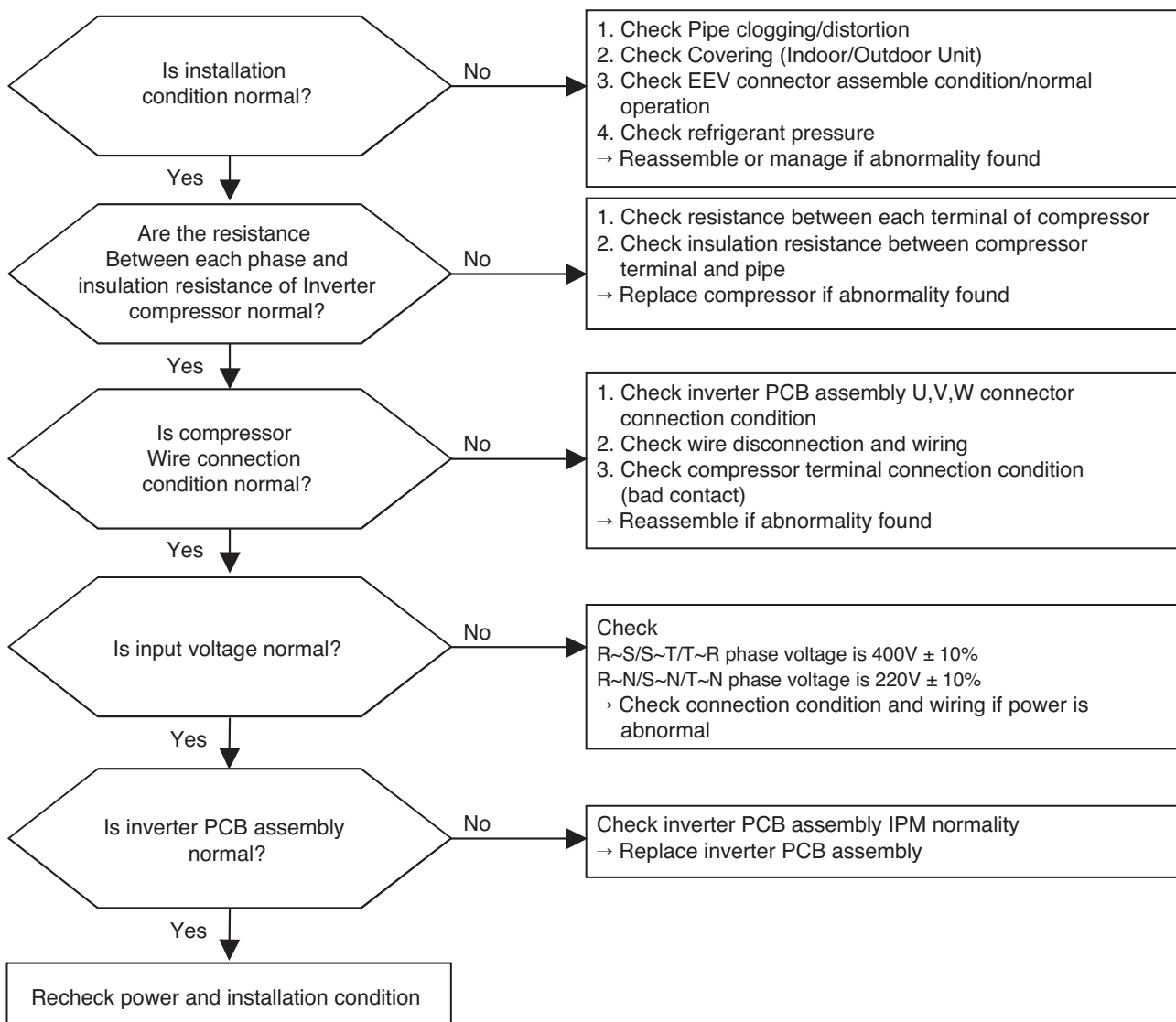
**■ Error Diagnosis and Countermeasure Flow Chart**

## 4. Trouble Shooting

Display code	Title	Cause of error	Check point & Normal condition
32	High temperature in Discharge pipe of the inverter compressor	<ul style="list-style-type: none"> <li>• Overload operation (Outdoor fan constraint, screened, blocked)</li> <li>• Refrigerant leakage (insufficient)</li> <li>• Poor INV Comp Discharge sensor</li> <li>• LEV connector displaced / poor LEV assembly</li> </ul>	<ul style="list-style-type: none"> <li>• Check outdoor fan constraint/ screened/ flow structure</li> <li>• Check refrigerant leakage</li> <li>• Check if the sensor is normal</li> <li>• Check the status of EEV assembly</li> </ul>



### WARNING

Before checking PCB or each outdoor electric parts, wait for 3 minutes after the power is off. When measuring at standby state of power supply, after checking the measurement mode of the meter, be careful of the short-circuits with other parts.

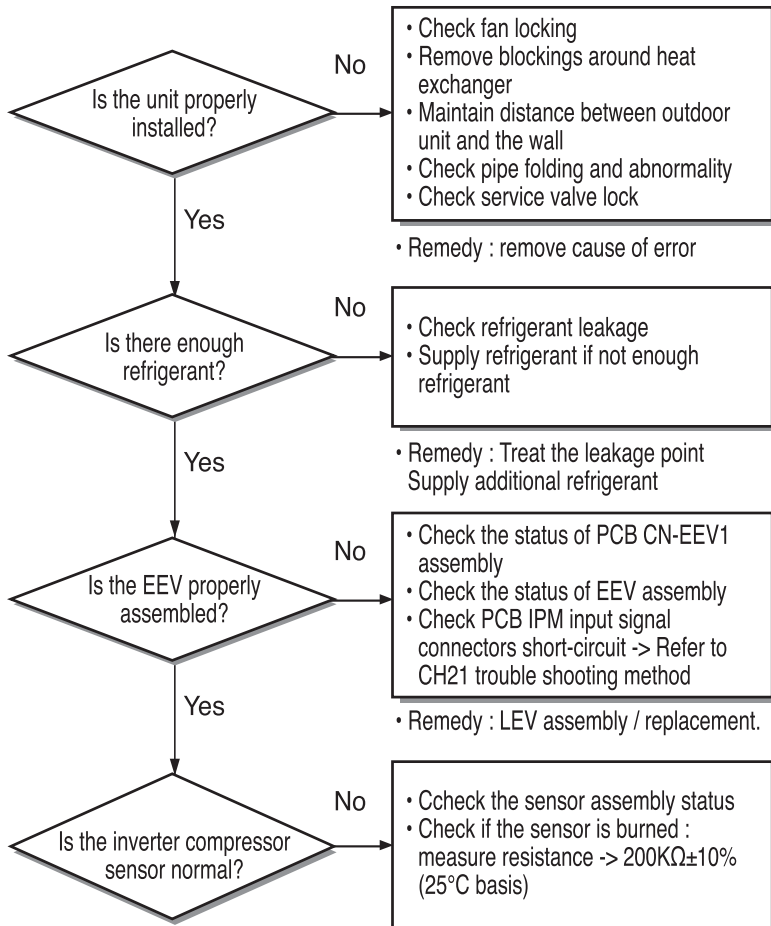

### • Inspecting Inverter Compressor Discharge Sensor

1. Set Multi-tester as resistance measurement mode.
2. Measure the resistance between inverter discharge sensor connector pins.
3. Measure resistance value of  $200\text{K}\Omega \pm 10\%$ ,  $25^\circ\text{C}$  basis
4. Check if the sensor insulation is damaged. -> measure the resistance between sensor connector pin and unit assembly pipe. ( $1\text{M}\Omega$  or more)

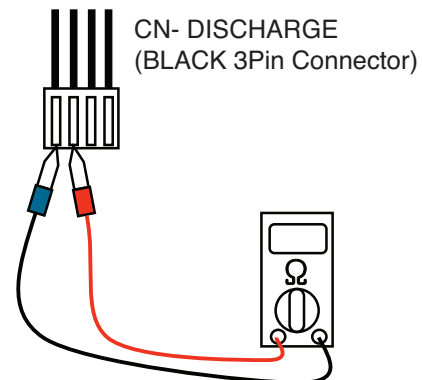

Display code	Title	Cause of error	Check point & Normal condition
35	Low Presser Error	Excessive decrease of low pressure	<ul style="list-style-type: none"> <li>• Defective low pressure sensor</li> <li>• Defective outdoor/indoor unit fan</li> <li>• Refrigerant shortage/leakage</li> <li>• Deformation because of damage of refrigerant pipe</li> <li>• Defective indoor / outdoor unit EEV</li> <li>• Covering / clogging (outdoor unit covering during the cooling mode / indoor unit filter clogging during heating mode)</li> <li>• SVC valve clogging</li> <li>• Defective outdoor unit PCB</li> <li>• Defective indoor unit pipe sensor</li> </ul>

■ Error diagnosis and countermeasure flow chart

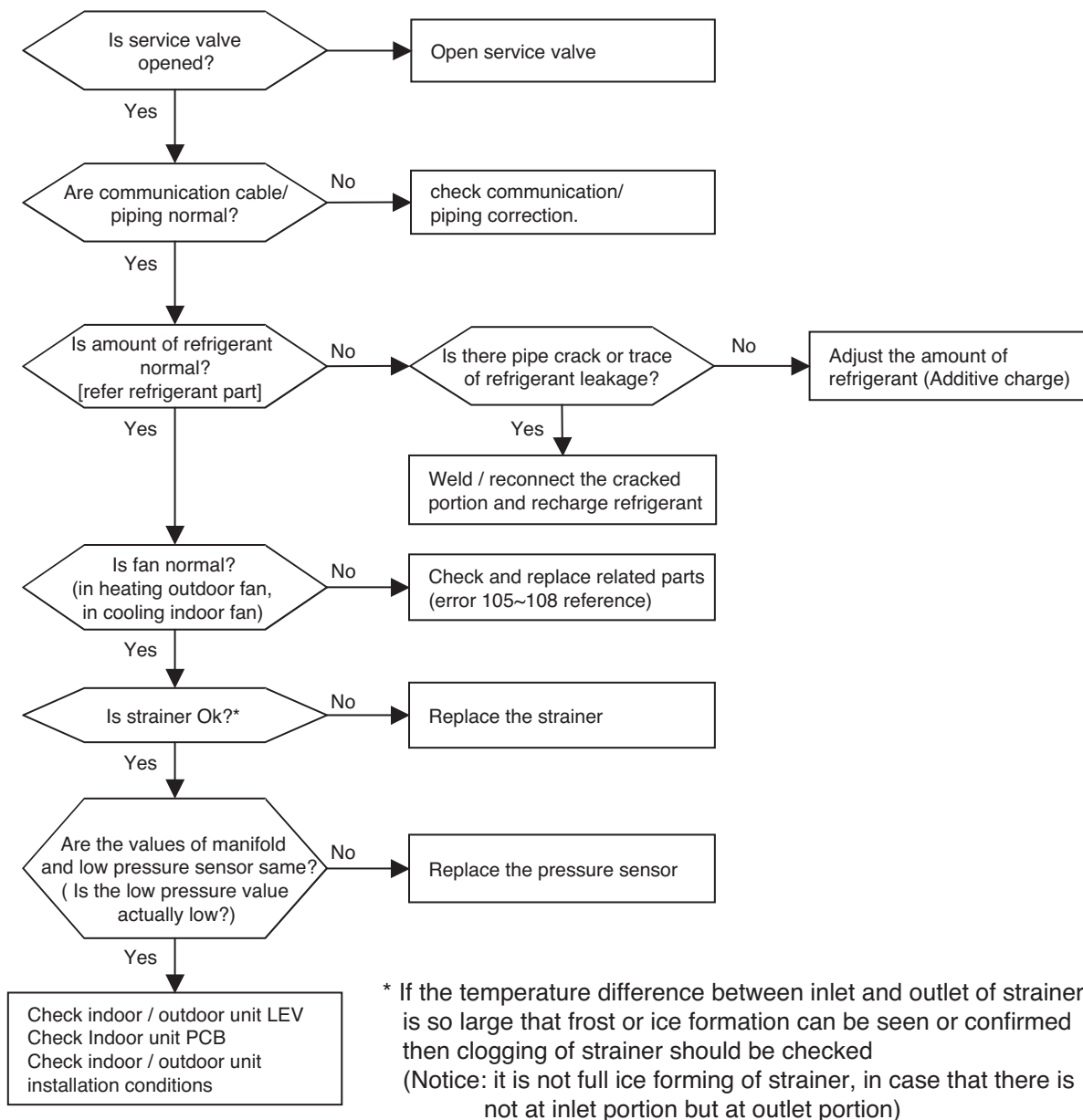

#### 4. Trouble Shooting

Display code	Title	Cause of error	Check point & Normal condition
39	Transmission Error Between (PFC Micom → INV Micom)	Communication Error Between PFC Micom and INV Micom.	1. Micom defect/Circuit defect 2. Different Micom S/W Version 3. ODU inverter PCB assembly damage

#### ■ Error Diagnosis and Countermeasure Flow Chart

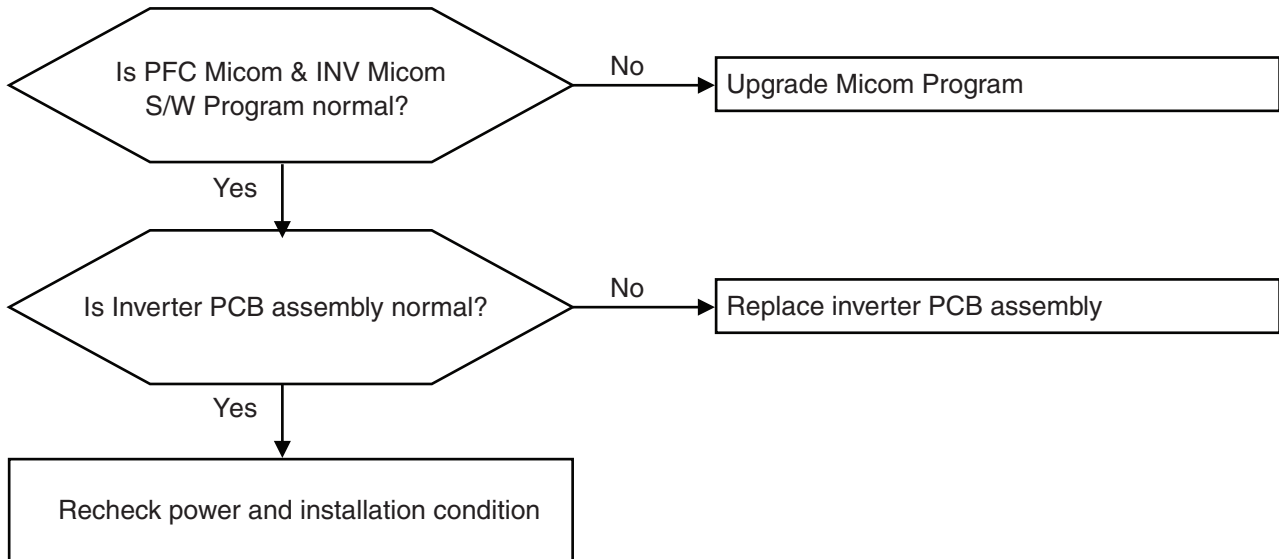

Display code	Title	Cause of error	Check point & Normal condition
40	C/T Sensor Error	<ul style="list-style-type: none"> <li>Initial current error</li> </ul>	<ul style="list-style-type: none"> <li>Malfunction of current detection circuit. (Open / Short)</li> <li>The voltage of "C01N" Is 4.0Vdc(25A) .</li> <li>Check CT Sensor output voltage : 2.5Vdc <math>\pm 5\%</math></li> </ul>

**■ Error Diagnosis and Countermeasure Flow Chart**

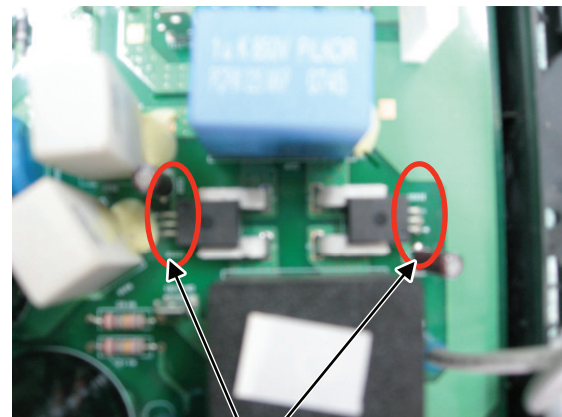
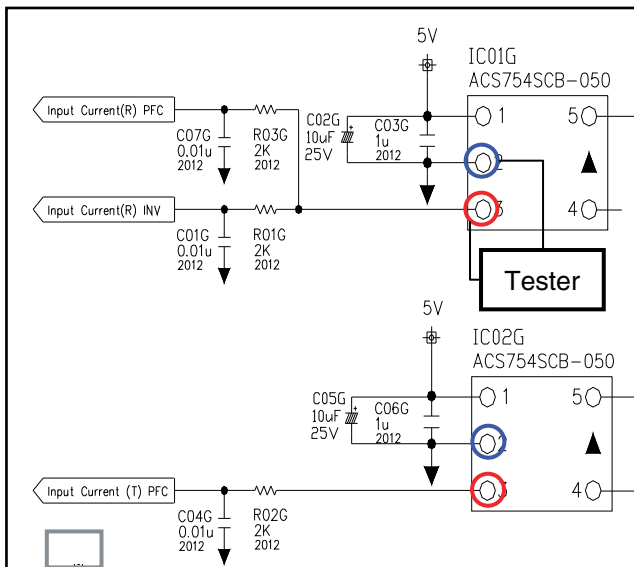
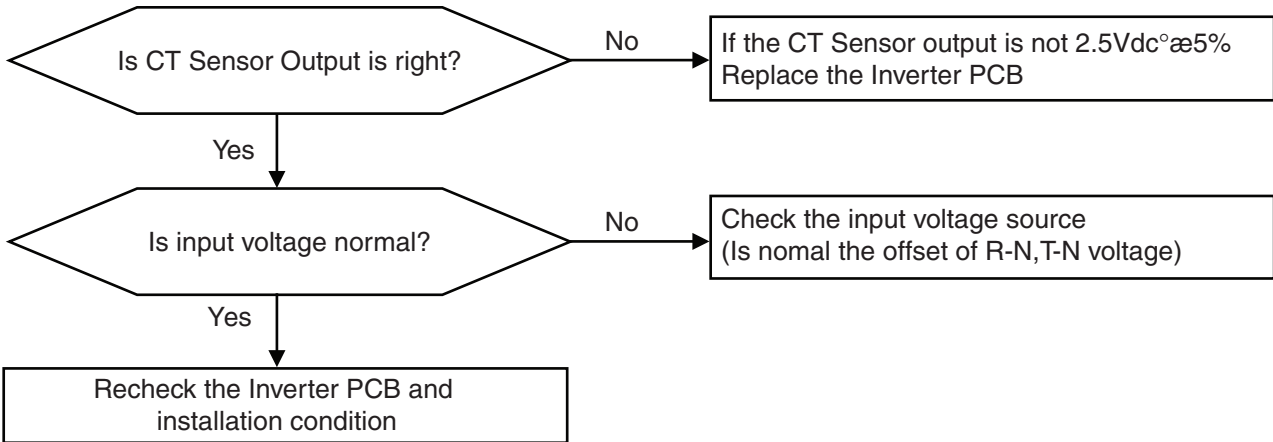

CT Sensor Output  
(at the INVERTER PCB)

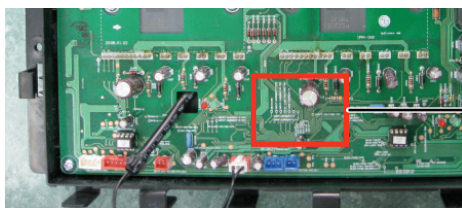

<INVERTER PCB>

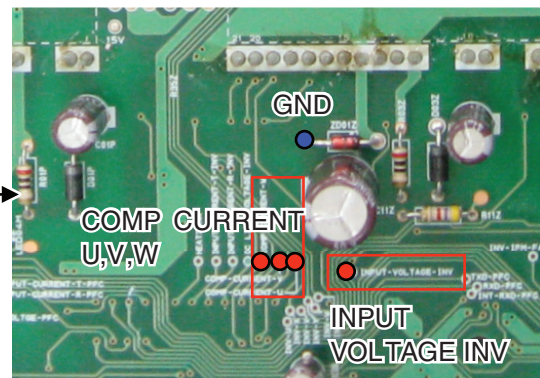

<INPUT VOLTAGE Check Point>



## 4. Trouble Shooting

Display code	Title	Cause of error	Check point & Normal condition
41	D-pipe sensor (Inverter)	<ul style="list-style-type: none"> <li>• Open / Short</li> <li>• Soldered poorly</li> <li>• Internal circuit error</li> </ul>	<ul style="list-style-type: none"> <li>• Normal resistor : 200K<math>\Omega</math> / at 25°C (Unplugged)</li> </ul>
43	Sensor error of high pressure	Abnormal value of sensor (Open/Short)	<ul style="list-style-type: none"> <li>• Bad connection of connector PCB</li> <li>• Bad connection high pressure connector</li> <li>• Defect of high pressure connector (Open/Short)</li> <li>• Defect of connector PCB (Open/Short)</li> <li>• Defect of outdoor main PCB.</li> </ul>
44	Air sensor	<ul style="list-style-type: none"> <li>• Open / Short</li> <li>• Soldered poorly</li> <li>• Internal circuit error</li> </ul>	<ul style="list-style-type: none"> <li>• Normal resistor : 10K<math>\Omega</math> / at 25°C (Unplugged)</li> </ul>
45	Condenser Mid-pipesensor	<ul style="list-style-type: none"> <li>• Open / Short</li> <li>• Soldered poorly</li> <li>• Internal circuit error</li> </ul>	<ul style="list-style-type: none"> <li>• Normal resistor : 5K<math>\Omega</math> / at 25°C (Unplugged)</li> </ul>
46	Suction Pipe sensor	<ul style="list-style-type: none"> <li>• Open / Short</li> <li>• Soldered poorly</li> <li>• Internal circuit error</li> </ul>	<ul style="list-style-type: none"> <li>• Normal resistor : 5K<math>\Omega</math> / at 25°C (Unplugged)</li> </ul>
48	Condenser Out-pipe sensor	<ul style="list-style-type: none"> <li>• Open / Short</li> <li>• Soldered poorly</li> <li>• Internal circuit error</li> </ul>	<ul style="list-style-type: none"> <li>• Normal resistor : 5K<math>\Omega</math> / at 25°C (Unplugged)</li> </ul>
65	Heat sink sensor	<ul style="list-style-type: none"> <li>• Open / Short</li> <li>• Soldered poorly</li> <li>• Internal circuit error</li> </ul>	<ul style="list-style-type: none"> <li>• Normal resistor : 10K<math>\Omega</math> / at 25°C (Unplugged)</li> </ul>

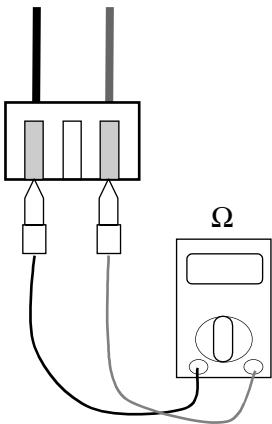

### Check Point

1. Estimate the resistance of each sensor.(Unplugged)
2. Estimate the voltage of each sensor.(Plugged)
3. If the resistance of the sensor is 0 k $\Omega$  or  $\infty$ , then sensor is abnormal.  
If the voltage of the sensor is 0 V or 5Vdc, then sensor is abnormal.

Display code	Title	Cause of error	Check point & Normal condition
51	Over capacity	<ul style="list-style-type: none"><li>• Over capacity</li></ul>	<ul style="list-style-type: none"><li>• Check the indoor unit capacity.</li><li>• Check the combination table.</li></ul>
60	Over capacity	<ul style="list-style-type: none"><li>• Check sum error</li></ul>	<ul style="list-style-type: none"><li>• Check the PCB ASM P/No.</li><li>• Check the poor soldering.</li></ul>

## 4. Trouble Shooting

Display code	Title	Cause of error	Check point & Normal condition
53	Title Communication (Indoor → Outdoor)	• Communication poorly	<ul style="list-style-type: none"> <li>• Power input AC 220V. (Outdoor, Indoor)</li> <li>• The connector for transmission is disconnected.</li> <li>• The connecting wires are misconnected.</li> <li>• The communication line is shorted at GND.</li> <li>• Transmission circuit of outdoor PCB is abnormal.</li> <li>• Transmission circuit of indoor PCB is abnormal.</li> </ul>

### Check Point

1. Check the input power AC230V. (Outdoor, Indoor unit)
2. Check the communication wires are correctly connected.  
Adjust the connection of wire Confirm the wire of "Live", "Neutral"
3. Check the resistance between communication line and GND. (Normal : Over 2MΩ)
4. Check the connector for communication is correctly connected.
5. If one indoor unit is operated normally, outdoor PCB is no problem.  
Check the another indoor unit.  
\* CH05 is displayed at indoor unit, CH53 is displayed at outdoor unit.
6. If all indoor unit is displayed CH05 but outdoor PCB not display
  - 1) In Case of CH05, Check the Connection
    - CN-POWER, CN-COMM at the Main PCB
    - CN-MAIN at the Noise Filter
  - 2) In Case of CH53, Check the Connection
    - CN-COMM at the Main PCB
    - CN-MAIN-COMM, CN-AC-220V at the Inverter PCB
    - CN- INVERTER at the Noise Filter

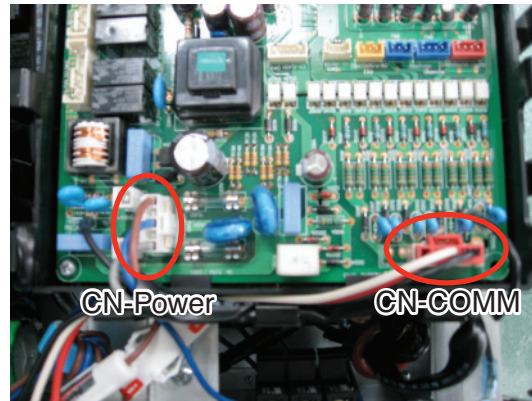

< MAIN PCB >

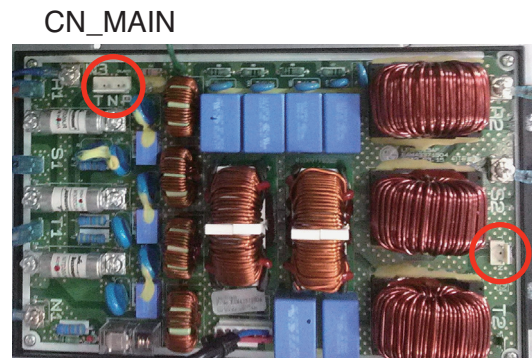

CN\_INVERTER

< Noise Filter >

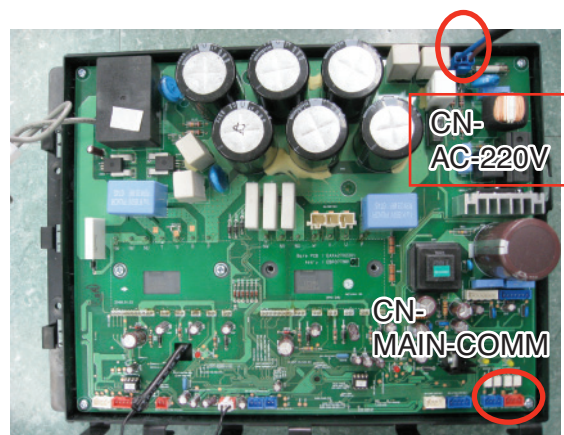

< INVERTER PCB >

Display code	Title	Cause of error	Check point & Normal condition
54	3-phase wrong wiring of main outdoor unit	<ul style="list-style-type: none"> <li>• 3-phase wrong wiring of outdoor unit (Reverse Phase /omission of phase)</li> </ul>	<ul style="list-style-type: none"> <li>• Abnormal Main PCB</li> <li>• No connection of CN_Phase</li> <li>• Changed R, S, T connection order</li> </ul>

■ Error Diagnosis and Countermeasure Flow Chart

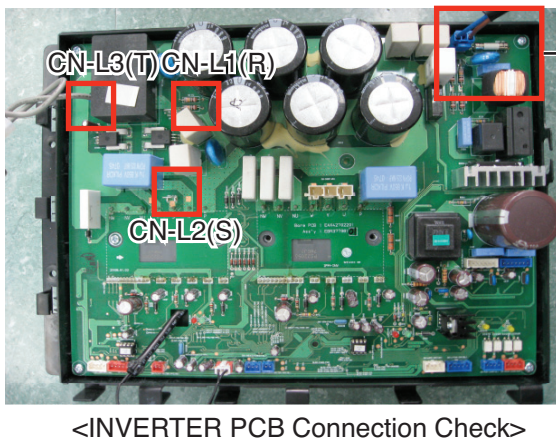
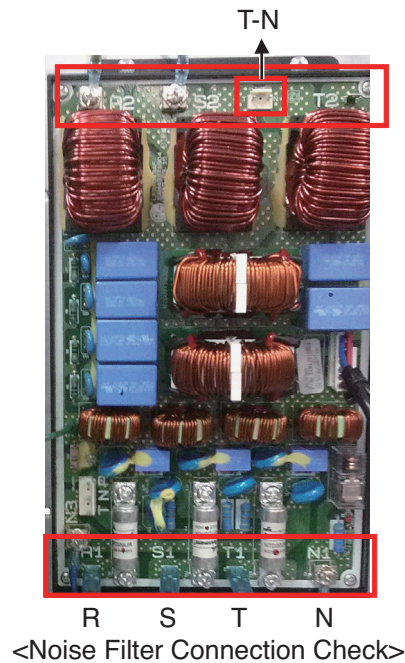
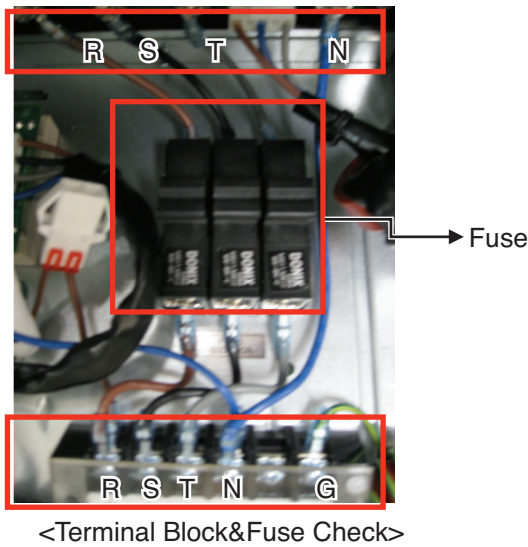
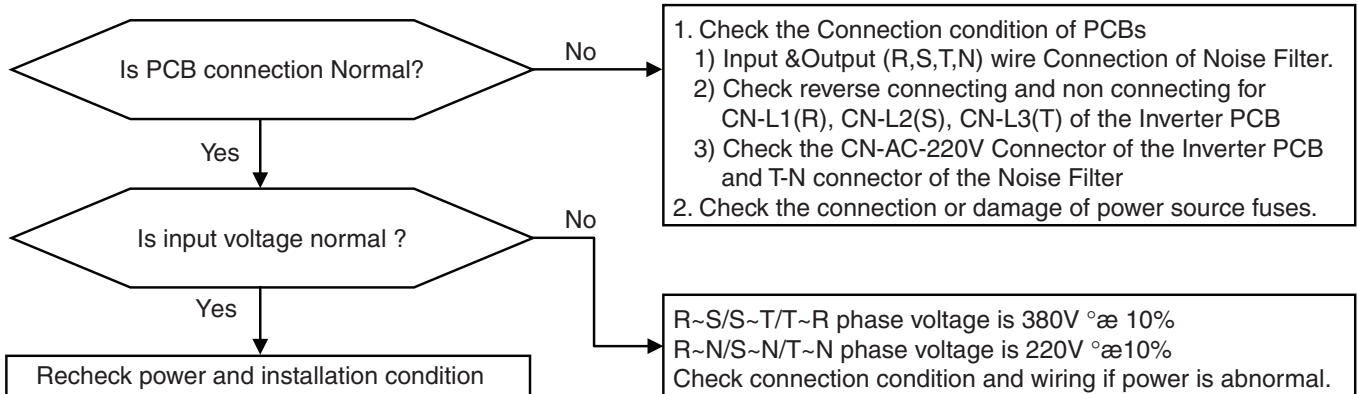

#### 4. Trouble Shooting

Display code	Title	Cause of error	Check point & Normal condition
61	Condenser pipe sensor temp. high	<ul style="list-style-type: none"> <li>Condenser pipe sensor detected high temp.(65°C)</li> </ul>	<ul style="list-style-type: none"> <li>Check the load condition.</li> <li>Check the sensor of Condenser pipe sensor.</li> </ul>
62	Heat sink sensor temp. high	<ul style="list-style-type: none"> <li>Heat sink sensor detected high temp.(85°C)</li> </ul>	<ul style="list-style-type: none"> <li>Check the Heat sink sensor (10kΩ ±10% at 25°C)</li> <li>Check that outdoor fan is driving rightly</li> </ul>

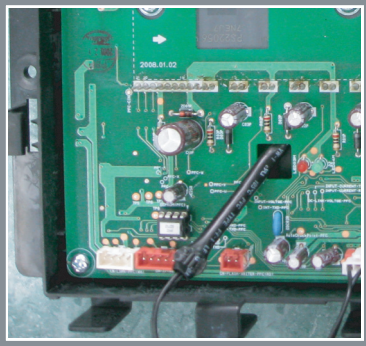

Comp frequency control according to heatsink temp.

#### ■ Comp frequency control according to heat sink temp.

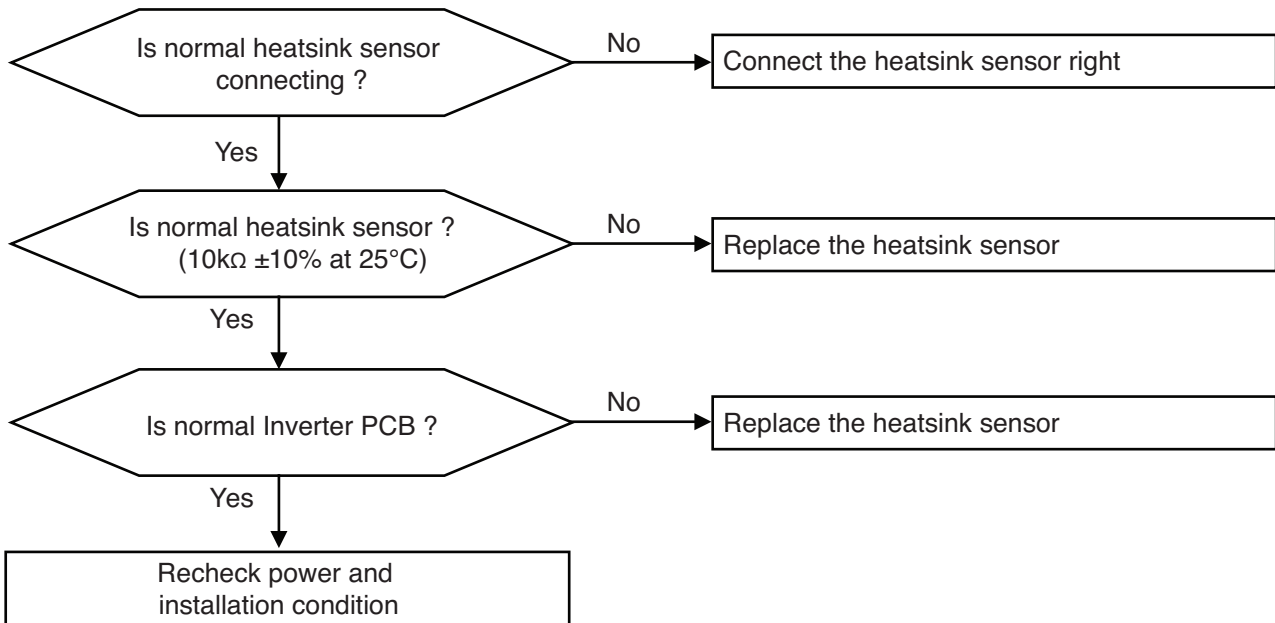

Display code	Title	Cause of error	Check point & Normal condition
65	Heatsink Sensor error	Inverter PCB heatsink sensor is open or short	1. ODU fan locking 2. Heatsink assembly of INV PCB assemble condition abnormal 3. Defect of temperature sensing circuit part defect of INV PCB

### ■ Error Diagnosis and Countermeasure Flow Chart

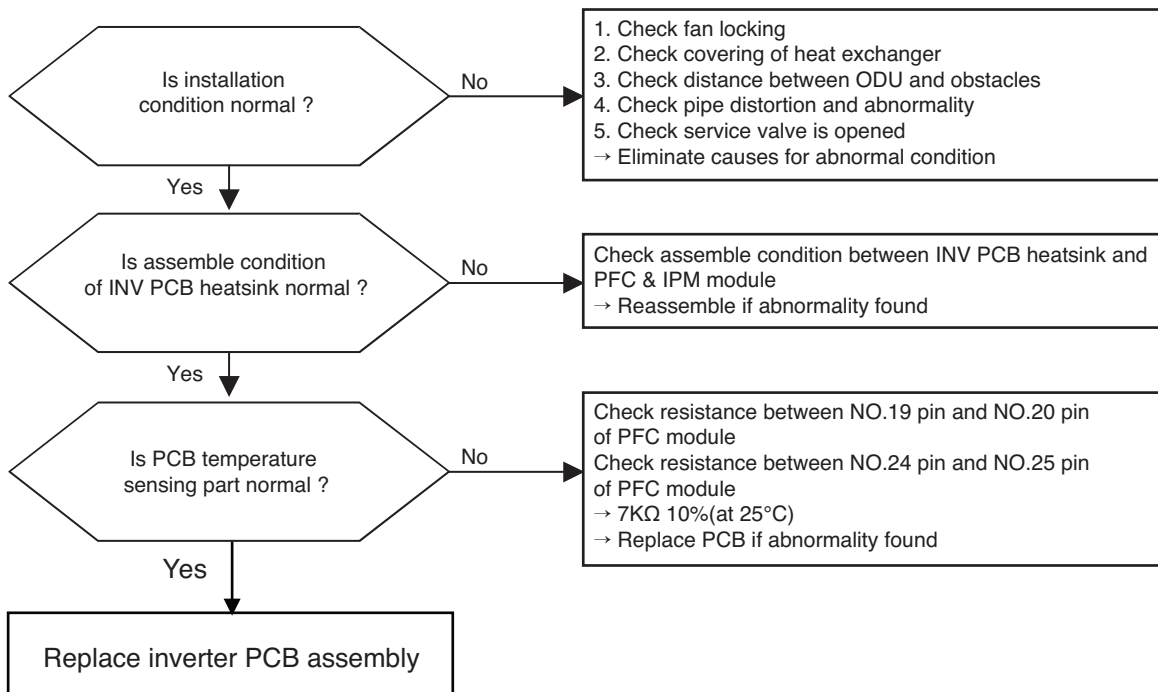

### Check Point

1. Check resistance between No.19 pin and NO.20 pin of PCB PFC module
2. Check resistance between No.24 pin and NO.25 pin of PCB PFC module
3. Resistance value should be in  $7k\Omega \pm 10\%$ .(at 25°C).
4. Check the PFC Module No.19, 20 and IPM Module No.24, 25 pin soldering condition.

## 4. Trouble Shooting

Display code	Title	Cause of error	Check point & Normal condition
67	Outdoor fan lock	<ul style="list-style-type: none"> <li>Outdoor fan is not operating</li> </ul>	<ul style="list-style-type: none"> <li>Check the fan condition.</li> <li>Check the fan connector</li> <li>Check the fan control part of the INVERTER PCB</li> </ul>

### ■ Error Diagnosis and Countermeasure Flow Chart

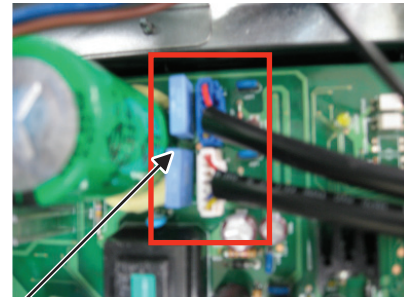
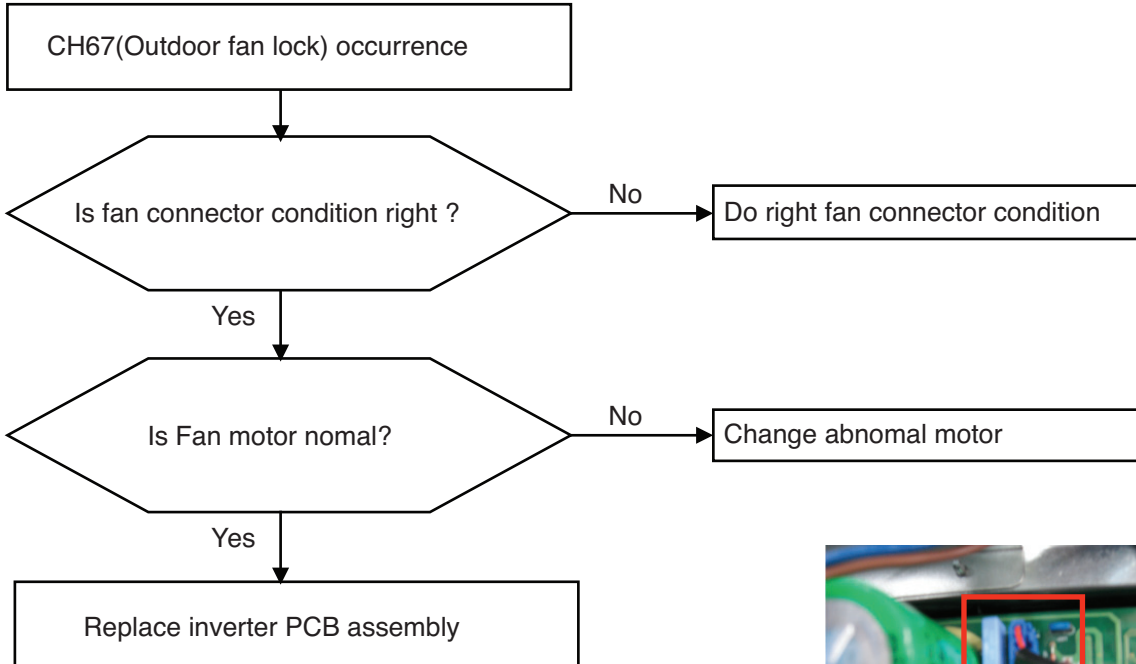

<INVERTER PCB connection>

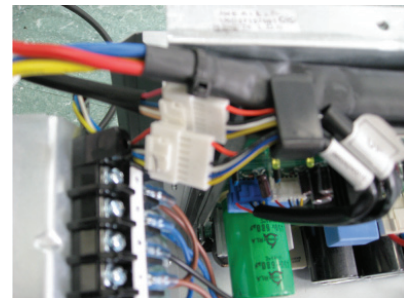

<fan motor middle connection>

<FAN Motor Connection check>

### Check Point

1. Check error code again, after replacing the abnormal part (Fan Motor or PCB) first.

Display code	Title	Cause of error	Check point & Normal condition
73	AC input instant over current error (Matter of software)	Inverter PCB input power current is over 48A(peak) for 2ms	<ol style="list-style-type: none"> <li>1. Overload operation (Pipe clogging/Covering/EEV defect/Ref.overcharge)</li> <li>2. Compressor damage (Insulation damage/Motor damage)</li> <li>3. Input voltage abnormal (L, N)</li> <li>4. Power line assemble condition abnormal</li> <li>5. Inverter PCB assembly damage (input current sensing part)</li> </ol>

■ Error Diagnosis and Countermeasure Flow Chart

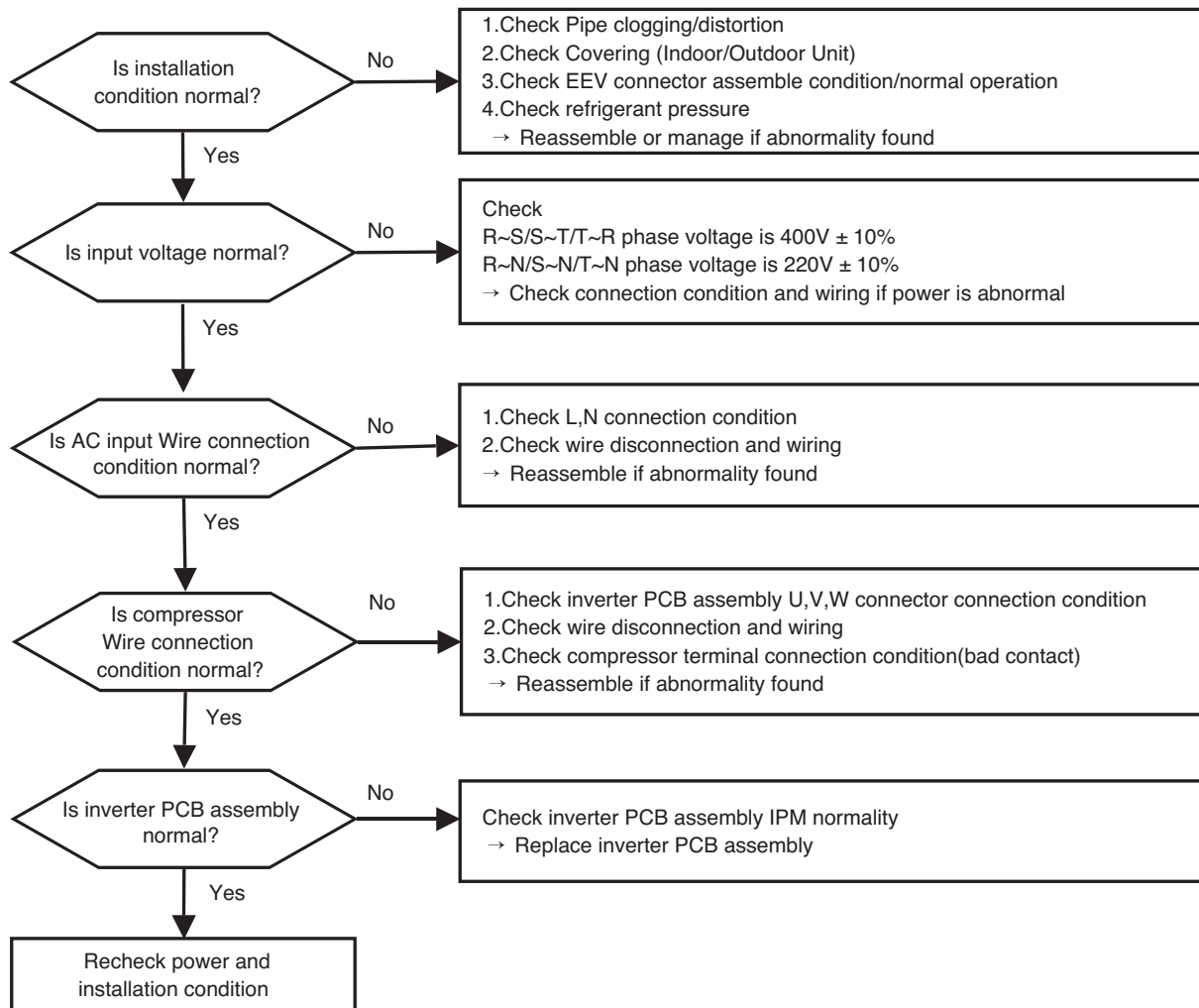





P/NO : MFL67478302

July, 2012